

# RF Connector guide





**HUBER+SUHNER®**

# **RF CONNECTOR GUIDE**

**Understanding connector technology**

Published by HUBER+SUHNER  
([www.hubersuhner.com](http://www.hubersuhner.com))

HUBER+SUHNER RF CONNECTOR GUIDE  
4th edition, 2007

HUBER+SUHNER® is a registered trademark of HUBER+SUHNER AG

Copyright© HUBER+SUHNER AG, 1996

Published in Switzerland by HUBER+SUHNER AG, Switzerland

All rights reserved.

In particular no part of this publication may be reproduced, stored, or translated, or transmitted in any form or by any means, electronic, mechanical, photocopying, recording, or otherwise without the prior written permission of HUBER+SUHNER AG.

Request of reproduction must be addressed to HUBER+SUHNER AG, CEO.

Document no. 648116

Printed in Switzerland



# PREFACE

After having been in the RF Interconnection Market for more than fifty years, we felt the need to provide our business associates around the world with a booklet containing key information on coaxial connectors.

Today, key concepts behind RF technology have not changed much - and this is what this booklet, the *HUBER+SUHNER RF CONNECTOR GUIDE*, is all about. It contains HUBER+SUHNER know how and experience in the field of connectors. Primarily, we aim this booklet at non-technically and technically skilled people who are daily confronted with purchasing, distributing or maybe installing RF connectors.

The Guide is a reference to coaxial connectors, which embraces the underlying theory, design technology and performance features behind RF connectors. It should enhance the understanding of possible usage, so that people with no or little RF knowledge are able to consider or even select the best suitable connector for their application problem. However, we have to stress that the Guide cannot stand alone as a definite solution to all connector problems. .

The chapters of this booklet are arranged chronologically, starting with RF theory and ending with electrical measurements.

**Chapter 1** is a short form of general RF theory, which is partly based on fundamental electrotechnique. We have tried to simplify the description of the most used RF connector phrases and features, though not omitting the complementary. It is probably difficult to interpret the equations if the reader has no knowledge of electrotechnique. However, the attached explanations are thought to give the non-technical reader the gist of RF behaviour and thereby compensate for the various technical expressions.

**Chapter 2** contains an abstract of some of the materials used for coaxial connectors. Knowledge of material technology is important as the material influences the flexibility of design and the performance of the connectors, which applies to both the base materials and the surface finish, i.e. the plating. This chapter is supplemented by the Appendices 5.1 and 5.2, which contain tables with quantities characterising the materials (5.2) and electrochemical potentials (5.1) between them, respectively.

**Chapter 3** is about the design features of connectors and connector series. Every series has a different design and features that vary. This is important to know because the connector performance has to stand up to the requirements of the application. Additionally, some of the typical applications or market segments in which the connectors are being applied are listed.

**Chapter 4** is intended to give the reader an impression and practical cognition of the electrical test and measurement techniques for coaxial connectors. As with the theory in Chapter 1, the parameter theory behind the measurement quantities is described to provide the reader with background information. Furthermore, it is valuable input for the understanding of the measurement procedures and eventually of the graphs resulting from the practical tests.

The glossary is a summary of common RF expressions. It should help the reader to find explanations to specific terms quickly without having to flip through the whole booklet first.

The company portrait is also included in this booklet if further information about our company is desired.

Finally, a separate formula booklet is enclosed in the pocket at the back cover of this booklet. It contains all equations described in the *GUIDE*. Among other things, it includes conversion tables to convert reflection quantities into, say, return loss.

I hope you will find the *HUBER+SUHNER RF CONNECTOR GUIDE* as useful as we wanted it to be.

HUBER+SUHNER AG  
July 2007

<b>CONTENTS</b>	<b>PAGE</b>
CHAPTER 1: INTRODUCTION TO BASIC RF THEORY .....	9
CHAPTER 2: MATERIALS .....	41
CHAPTER 3: RF CONNECTOR DESIGN .....	59
CHAPTER 4: TESTS AND MEASUREMENTS .....	109
CHAPTER 5: APPENDICES .....	136
CHAPTER 6: REFERENCES .....	143
CHAPTER 7: INDEX .....	161
CHAPTER 8: NOTES .....	165



# 1. INTRODUCTION TO BASIC RF THEORY

CONTENTS	PAGE
1.1 DEFINITION AND GRADUATION OF HIGH FREQUENCY . . . . .	9
1.1.1 Band Designations . . . . .	10
1.2 CONSTRUCTION AND FUNCTION OF RF LINES . . . . .	11
1.2.1 Types of RF Lines . . . . .	11
1.2.2 A Typical RF Line . . . . .	12
1.2.3 Electromagnetic Field along a RF Line . . . . .	12
1.2.4 Resistances and Reactances in a RF Line . . . . .	15
1.2.5 Impedance of the RF Line . . . . .	16
1.2.5.1 Characteristic Impedance of a low-loss Line at High Frequencies . . . . .	16
1.2.6 Cut-off Frequency . . . . .	18
1.2.7 Wavelength and Frequency . . . . .	19
1.2.7.1 Relationship between Frequency and Wavelength . . . . .	20
1.2.8 Velocity of Propagation . . . . .	20
1.2.8.1 Influence of Dielectric Material on the Velocity of Propagation . . . . .	21
1.3 REFLECTIONS . . . . .	22
1.3.1 Reflected Wave (Voltage) . . . . .	22
1.3.2 Reflection from Various Discontinuities . . . . .	23
1.3.3 Terms for Definition of the Mismatch . . . . .	25
1.3.3.1 Reflection Coefficient $\Gamma$ . . . . .	25
1.3.3.2 Return Loss $R_L$ . . . . .	26
1.3.3.3 Voltage Standing Wave Ratio VSWR . . . . .	27
1.3.4 Comparison between $\Gamma$ , $R_L$ and VSWR . . . . .	29
1.3.5 Reflection from two or more Discontinuities . . . . .	30

<b>1.4</b>	<b>ATTENUATION LOSS OF RF LINES</b> . . . . .	<b>31</b>
1.4.1	Determination of the Attenuation Loss . . . . .	32
1.4.2	Attenuation Loss Components of Conductor and Dielectric . . . . .	32
1.4.3	Shielding . . . . .	33
<b>1.5</b>	<b>THE SKIN EFFECT</b> . . . . .	<b>35</b>
<b>1.6</b>	<b>PASSIVE INTERMODULATION (PIM)</b> . . . . .	<b>36</b>
1.6.1	Specifications . . . . .	37



# 1 INTRODUCTION TO BASIC RF THEORY

## 1.1 DEFINITION AND GRADUATION OF HIGH FREQUENCY

In this first chapter, the main emphasis is laid on explanations to typical parameters in the theory of RF transmission lines, containing coaxial connectors and cables. It should give an impression of how and why transmission lines perform as they do. At the same time, it should provide the reader with fundamental knowledge of common RF techniques including equations, thought as a help or base for the following chapters. In the first section of this chapter, we try to define what high frequency is compared to low frequency and how various frequency ranges are divided.

When we look at an equivalent circuit model with a resistive (ohmic) element, the resistance  $R$  in a low frequency (LF) circuit will be transformed into capacitive and inductive resistances,  $C$  and  $L$  respectively, in a high frequency circuit (RF):

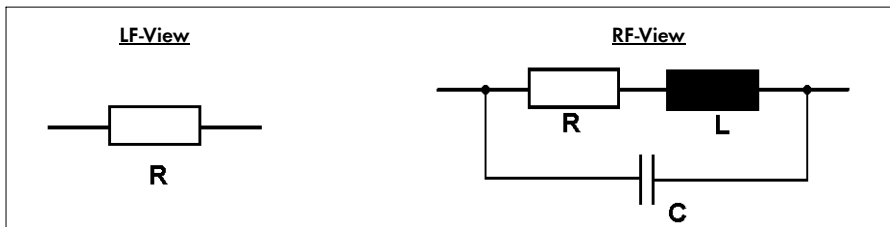

Figure 1 Equivalent LF and RF circuits with ohmic element

It is not possible to specify the exact limit between RF and LF. For example, when controlling transistors in the MHz range, LF parameters often have to be used in the calculation, and a LF range can be replaced with an equivalent RF circuit diagram (see Figure 2).

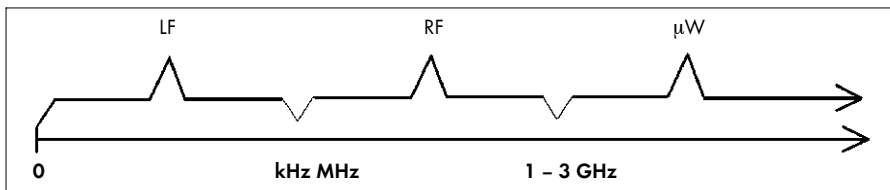

Figure 2 Frequencies divided into ranges from LF to microwaves

The limitation in the upper frequency range:

RF - techniques	Voltages and currents are defined.
μW - techniques (refer to Table 1)	Usually, only the <b>E</b> -(electric) or <b>H</b> -(magnetic) fields can be indicated

High frequency begins where currents and voltages become frequency dependent or where the wavelength becomes important ( $\lambda \approx$  length of component)

### 1.1.1 Band Designations

Abbreviations used:

<b>VLF</b>	very low frequency
<b>LF</b>	low frequency
<b>MF</b>	medium frequency
<b>RF</b>	high frequency
<b>VHF</b>	very high frequency
<b>UHF</b>	ultra high frequency
<b>SHF</b>	super high frequency
<b>EHF</b>	extremely high frequency

Number of Range	Frequency Range	Wavelength	Name	Abbreviation
4	3 ... 30 kHz	100 ... 10 km	Myriametre Waves (Longest waves)	<b>VLF</b>
5	30 ... 300 kHz	10 ... 1 km	Kilometre Waves (Long waves)	<b>LF</b>
6	300 ... 3000 kHz	1 ... 0.1 km	Hectometre Waves (Medium waves)	<b>MF</b>
7	3 ... 30 MHz	100 ... 10 m	Decametre Waves (Short waves)	<b>HF</b>
8	30 ... 300 MHz	10 ... 1 m	Metre Waves (Ultrashort waves)	<b>VHF</b>
9	300 ... 3000 MHz	1 ... 0.1 m	Decimetre Waves (Ultrashort waves)	<b>UHF*</b>
10	3 ... 30 GHz	10 ... 1 cm	Centimetre Waves (Micro waves)	<b>SHF*</b>
11	30 ... 300 GHz	1 ... 0.1 cm	Millimetre Waves	<b>EHF*</b>

Table 1 Band Designations according to "VO Funk" (Radio Transmission Association) according to DIN 40015.

\* Coaxial connectors with operating frequencies within these ranges will be dealt with here.

## 1.2 CONSTRUCTION AND FUNCTION OF RF LINES

Coaxial lines represent the most efficient method of transmitting signals from a source (Figure 3) via a RF line to a termination. The most commonly used method is that of cable assemblies, where the distance between the source and the termination is the assembly length.

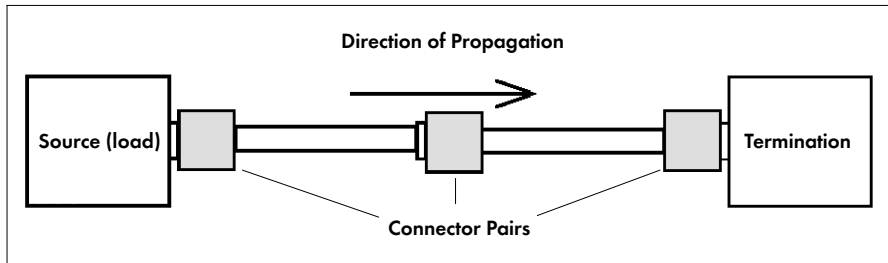

Figure 3 Direction of propagation along a RF line

The most important factor in connector selection is the RF cable chosen, as this usually will set the minimum connector specifications such as physical size, performance, etc. The connectors chosen must have an electrical specification (in terms of, for example: power) equal to, if not better than the specified cable. Cable and connectors (i.e. the complete assembly) will both contribute to losses and variations in the system.

**The purpose of RF lines is to guide RF signals from a source to a termination with minimal losses and changes**

### 1.2.1 Types of RF Lines

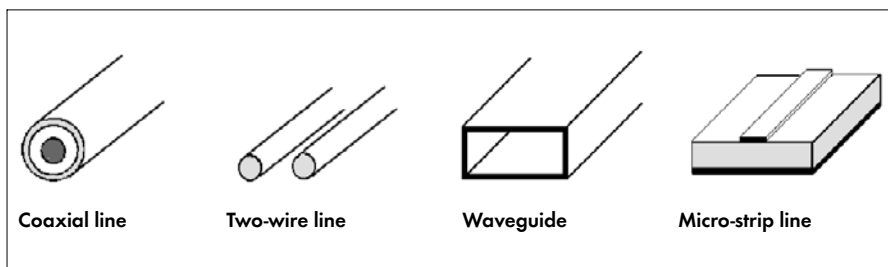

Figure 4 Various types of RF lines

## 1.2.2 A Typical RF Line



Figure 5 Construction of a RF line

Due to the concentric inner and outer conductor construction, the coaxial line is well protected against outside influences.

The signals will be transmitted in TEM-mode (Transversal Electric and Magnetic field) until the upper frequency limit, the so-called cut-off frequency (refer to Chapter 1.2.6 on page 18), is reached. The mechanical construction of the RF line determines this point. Basically, the smaller the mechanical dimensions the higher the frequencies. No fields exist in the direction of propagation of the energy.

(Transversal means the electric and the magnetic field lines are perpendicular to the cable axis).

The greater part of electrical properties are independent of the frequency, e.g. impedance and velocity of propagation. Only the attenuation loss increases at higher frequencies, caused by skin effect and dielectric losses. (For explanation of RF expressions refer to the Glossary).

## 1.2.3 Electromagnetic Field along a RF Line

The voltage and the current lines propagate in different ways within the RF line. The voltage waves (electric field lines) pulsate from the surface of the inner conductor towards the inner diameter of the outer conductor (see Figure 6).

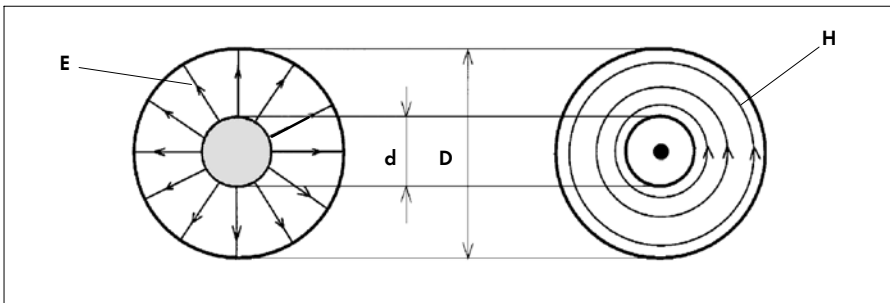

Figure 6 Cross section view: Electric and magnetic fields inside the RF line

The current propagates along the RF line causing a circular pulsating magnetic field around the inner conductor with the greatest intensity near its surface (refer to Figure 7 and Figure 8). The current creates a magnetic field, whereas the voltage causes an electric field inside the line.

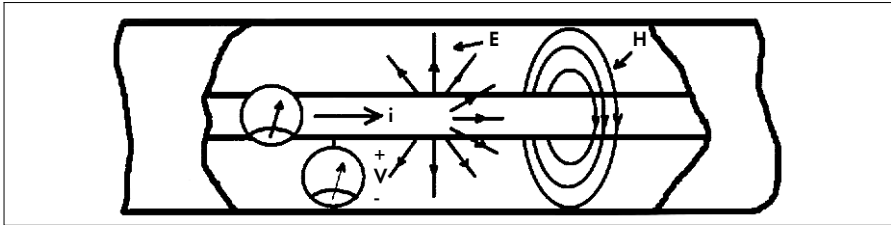

Figure 7 The electric and magnetic fields in a RF line

As references basic RF equations are included in this chapter, so that the relationship between connector factors can be shown.

The equations for calculation of the electric field and magnetic field are:

<p>Electric field <math>\vec{E}</math> (volts/metre)</p> $ E  = \frac{u}{\ln\left(\frac{D}{d}\right)} \times \frac{1}{r}$	(1)	<p>Magnetic field <math>\vec{H}</math> (amperes/metre)</p> $ H  = \frac{i}{2 \times \pi} \times \frac{1}{r}$	(2)
---------------------------------------------------------------------------------------------------------------------------	-----	--------------------------------------------------------------------------------------------------------------	-----

D = Inside diameter of outer conductor

d = Outer diameter of inner conductor

u = Voltage between inner and outer conductors (the so-called instantaneous potential difference across the line)

i = Current on the inner or outer conductors (the so-called instantaneous current)

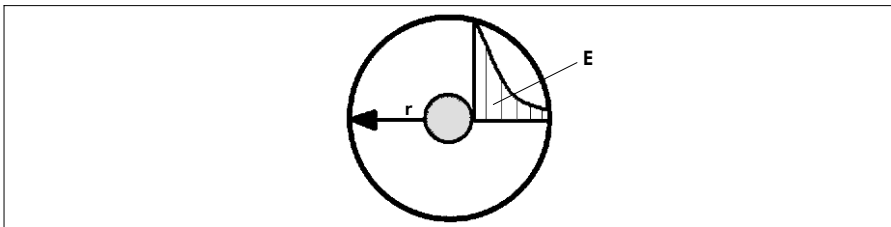

Figure 8 Electric field strength increases towards the inner conductor

The maximum field strength is most intense at the surface of the inner conductor. It will decrease with increasing electrical distance.

A longitudinal section view shows another view of the propagating voltage and current (refer to Figure 9 below).

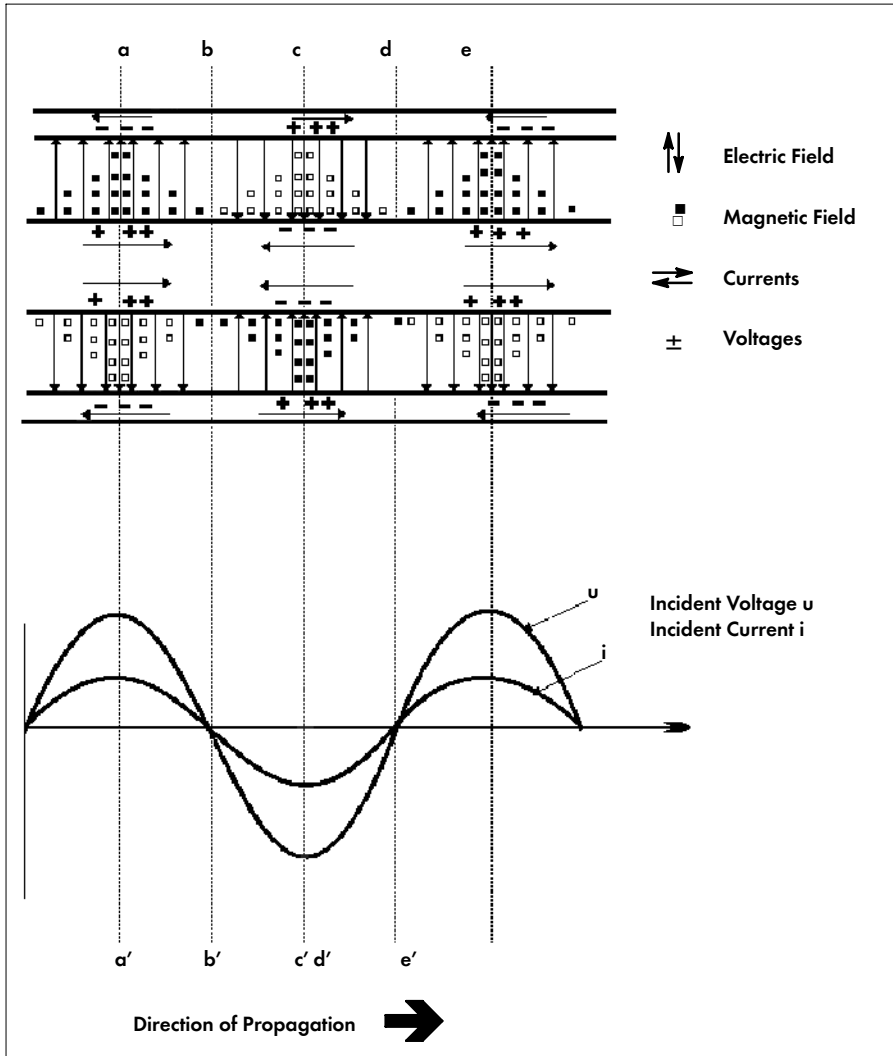

Figure 9 Longitudinal section view of travelling voltage and current (idealized)

The incident voltages and current travel together along the line at the same instant

### 1.2.4 Resistances and Reactances in a RF Line

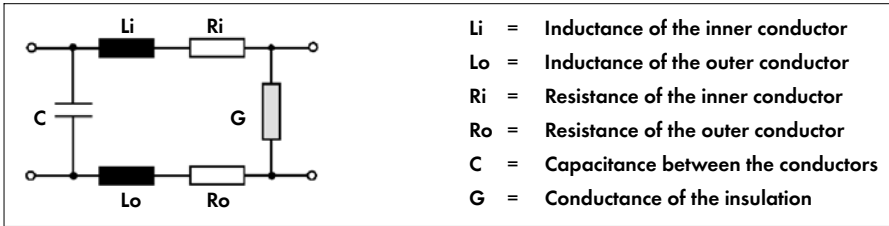

Figure 10 Equivalent circuit of RF line

If the inductances  $L_i$  and  $L_o$  and the resistances  $R_i$  and  $R_o$  are added up and the entire circuit is defined per unit length, the following equivalent circuit model results:

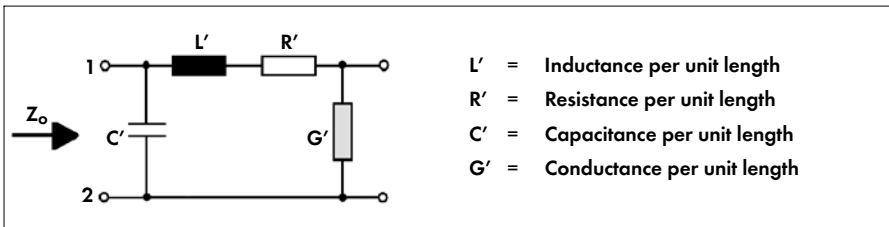

Figure 11 Equivalent circuit with L and R defined per unit length

Impedance  $Z_o$  = impedance between 1 and 2, source and termination (Figure 11).

$$Z_o = \sqrt{\frac{R' + j2\pi f L'}{G' + j2\pi f C'}} \quad (3)$$

At higher frequencies  $2\pi f L'$  is larger than  $R'$

At higher frequencies  $2\pi f C'$  is larger than  $G'$

$j$  = factor indicating a phase difference of  $90^\circ$

**At higher frequencies  $R'$  and  $G'$  have no influence on the impedance**

### 1.2.5 Impedance of the RF Line

If the dielectric is not solid but air, the waves propagate at the velocity of light  $c$ .

$$c = \frac{1}{\sqrt{\epsilon_0 \times \mu_0}} \quad (4)$$

( $\epsilon_0$  and  $\mu_0$  are described on page 20)

With a solid dielectric, the characteristic impedance of a standard transmission line is normally expressed as

$$Z_0 = \sqrt{\frac{R + j\omega L}{G + j\omega c}} \quad (5)$$

where  $\omega = 2\pi f$  and  $f$  is the frequency under consideration.  $j$  is the standard "operator" used in circuit analysis to indicate a phase difference of  $90^\circ$ .

The impedance of a coaxial line can also be determined by the ratio of diameters (refer to Figure 13) and the dielectric constant  $\epsilon_r$ .

$$Z = \frac{377\Omega}{2\pi\sqrt{\epsilon_r}} \times \ln \frac{D}{d} = \frac{60\Omega}{\sqrt{\epsilon_r}} \times \ln \frac{D}{d} = \frac{138\Omega}{\sqrt{\epsilon_r}} \times \log \frac{D}{d} \quad (6)$$

#### 1.2.5.1 Characteristic Impedance of a low-loss Line at High Frequencies

In a practical microwave circuit it is frequently possible to assume that a line is lossless (lossless line), i.e. that  $R$  and  $G$  are both zero whereupon the impedance is more simply expressed as:

$$Z_0 = \sqrt{\frac{L'}{C'}} \quad (7)$$

$L'$  = Cable inductance per unit length

$C'$  = Cable capacitance per unit length



or:

$$\text{Characteristic Impedance} = \frac{\text{Electric field strength}}{\text{Magnetic field strength}} \text{ [ohm]} = Z_0 = \frac{E}{H} \quad (8)$$

The ratio of the voltage to the current, (the electric and the magnetic field, respectively) in a travelling wave is constant, a property of the transmission line determined by the characteristic impedance, which is the same at any reference plane anywhere on the line, provided that the RF line is homogeneous (see Figure 12 below).

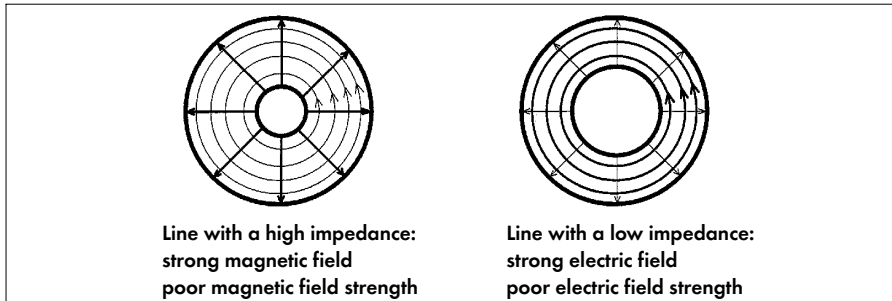

Figure 12 Different field strengths

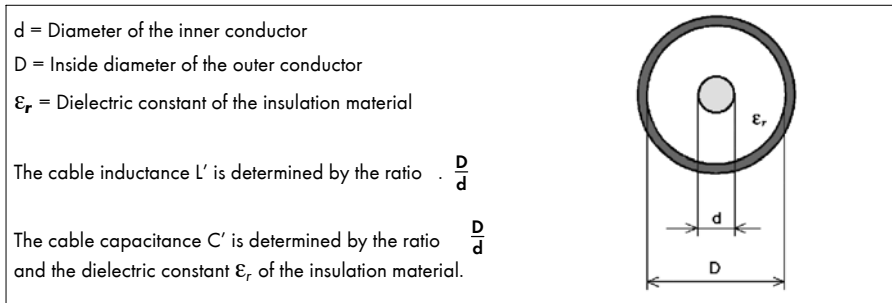

Figure 13 Diameters of inner and outer conductors

- **The impedance of a transmission (coaxial) line is determined by the ratio of outer conductor diameter to inner conductor diameter and by the dielectric constant  $\epsilon_r$  of the insulation material**
- **The impedance is independent of the line length and frequency (at approximately  $> 1$  MHz)**

Impedance	Air $\epsilon_r = 1$	Foam PE $\epsilon_r = 1.5$	PTFE $\epsilon_r = 2.05$	PE $\epsilon_r = 2.28$
50 $\Omega$	2.30	2.78	3.30	3.52
75 $\Omega$	3.49	4.63	6.00	6.60

Table 2 Diameter ratios  $\frac{D}{d}$  of various  $\epsilon_r$

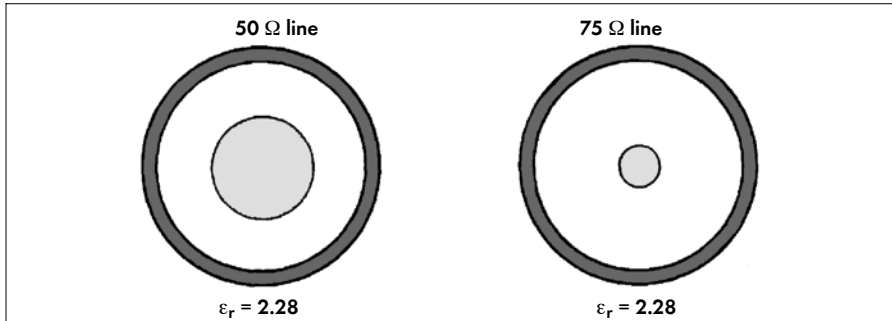

Figure 14 Different impedances caused by different insulator diameters

- A reduction of the inner conductor diameter increases impedance
- An increasing dielectric constant reduces impedance

### 1.2.6 Cut-off Frequency

As mentioned in Chapter 1.2.2, the upper frequency limit is also called the cut-off frequency and can be approximated by:

$$c \approx 300'000 \text{ km/s} \quad f_c \approx \frac{2 \times c}{(D + d) \times \pi \times \sqrt{\epsilon_r}} \quad (9)$$

The cut-off frequency is the frequency at which other waves than TEM waves can take place, i.e. a field component in the direction of propagation appears, causing significant changes in the characteristics of the RF line (e.g. resonances).

### 1.2.7 Wavelength and Frequency

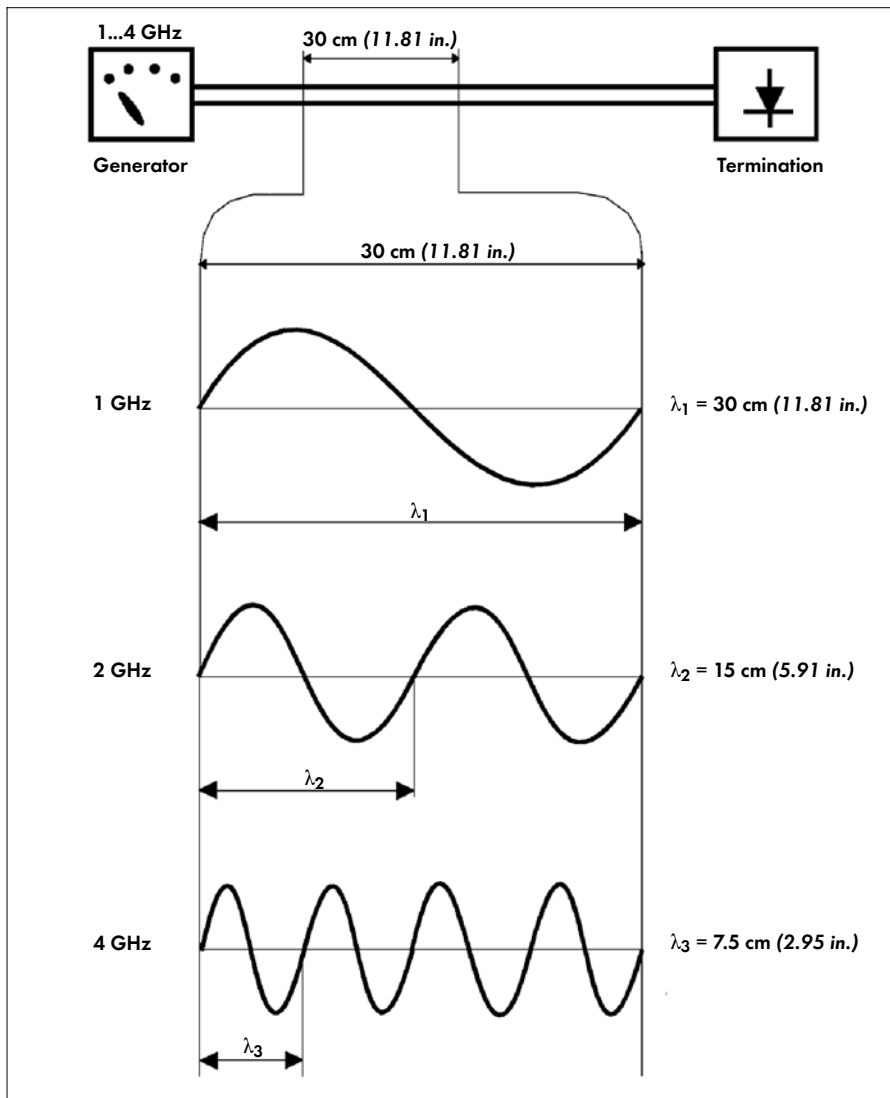

Figure 15 Frequency and wavelength

**The wavelength becomes shorter as the frequency increases**

### 1.2.7.1 Relationship between Frequency and Wavelength

The frequency and the wavelength are interdependent, a fact expressed by the following formulas:

$$v = \lambda \times f \text{ and } v = \frac{c}{\sqrt{\epsilon_r}} \text{ give} \quad (10)$$

$$\lambda = \frac{c}{f \times \sqrt{\epsilon_r}} \quad (11)$$

$v$  = Velocity of propagation

$\lambda$  = Wavelength

$f$  = Frequency

$\epsilon_r$  = Dielectric constant

### 1.2.8 Velocity of Propagation

The transmission of the electromagnetic energy is not attached to a medium, but can evolve in free space (see Chapter 1.2.3 on page 12). The energy propagates at the velocity of light in air (metres per second).

$$v = c = \sqrt{\frac{1}{\epsilon_0 \times \mu_0}} \quad (12)$$

The approximate value is:

$c \approx 300.000 \text{ km/s (186411 miles/s)}$

$\mu_0 = \text{Magnetic permeability of the medium (4.TT.10}^{-7} \text{ Henry/m)}$

$\epsilon_0 = \text{Electric permittivity (8.854.10}^{-12} \text{ Farad/m)}$

In a line, the velocity of propagation  $v$  is dependent on the dielectric constant  $\epsilon_r$  of the insulation material. Thereby, the following relationship applies.

$$v = \frac{c}{\sqrt{\epsilon_r}} \quad (13)$$

1.2.8.1 Influence of Dielectric Material on the Velocity of Propagation

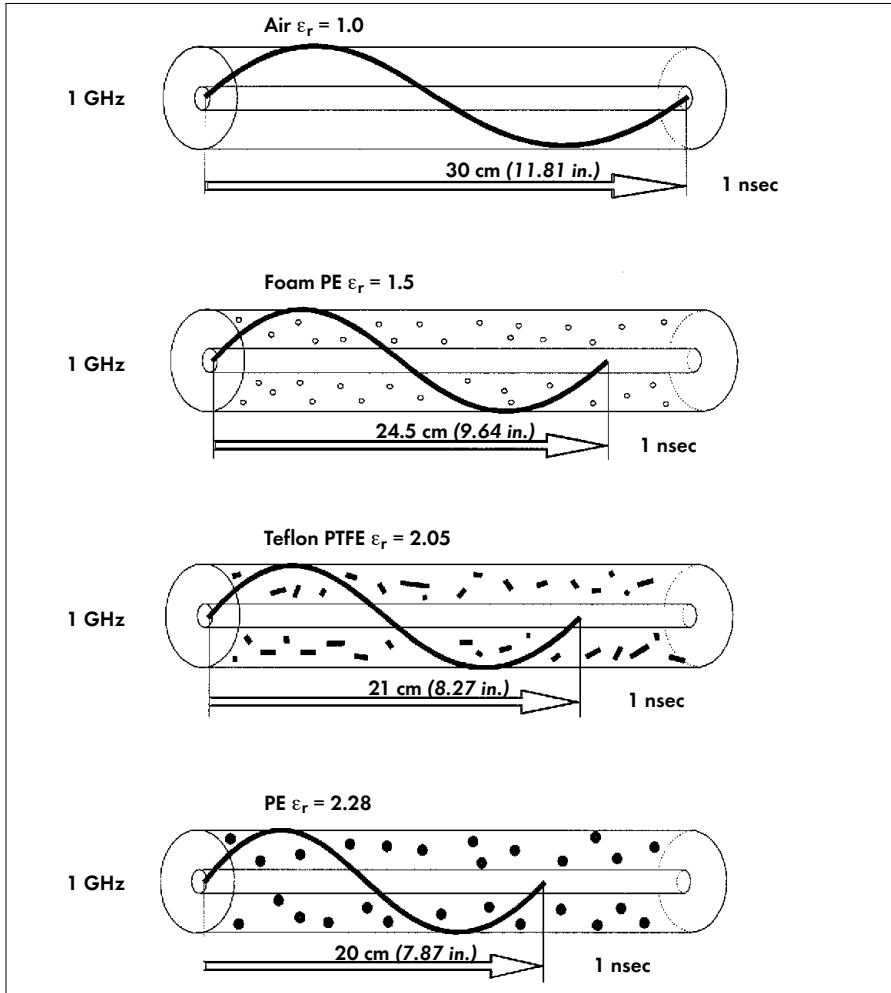

Figure 16 Wave propagation in various materials

- Every insulation material except air reduces the velocity of propagation
- Every insulation material except air reduces the wavelength
- Both effects increase along with the dielectric constant

## 1.3 REFLECTIONS

An example of a line with several discontinuities (steps):

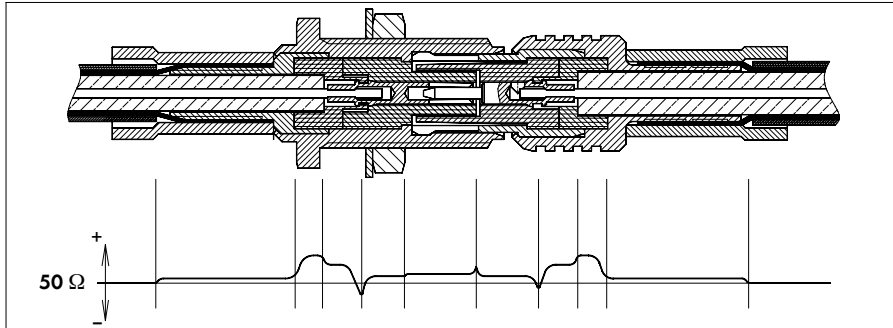

Figure 17 Change of impedance as a result of discontinuities (mated connector pair)

**A discontinuity on a RF line is a location where the impedance of the line changes**

Discontinuities can be a result of e.g.

- Changes in conductor diameters
- Change in insulator diameter
- Change in interface dimensions
- Space between parts (gaps)

### 1.3.1 Reflected Wave (Voltage)

A discontinuity can also be the short end itself in a short circuit, where there is total reflection.

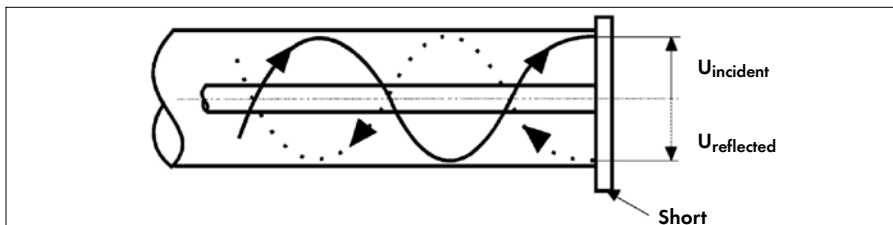

Figure 18 Short circuit

The travelling incident voltage meets another voltage of  $U_{\text{incident}}$  at the short.  
The reflected wave has the opposite voltage magnitude of  $U_{\text{reflected}}$ , thus the sum is zero.

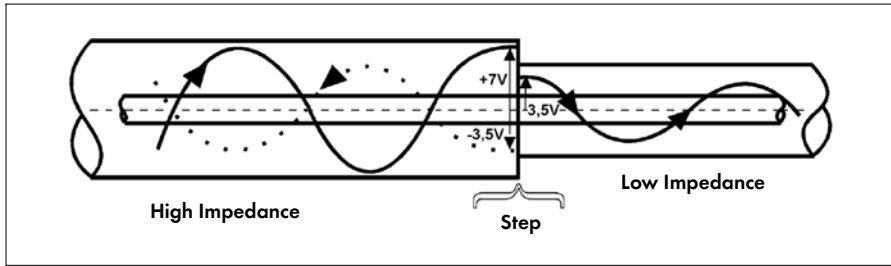

Figure 19 Discontinuity as a result of lower impedance (smaller insulator diameter)

The travelling wave arrives at the step with a magnitude of e.g. +7 V. The voltage must change because the impedance changes at the discontinuity. A fraction of the voltage will then be reflected (refer to Figure 19).

**The incident current will be reflected as well as the incident voltage, because the current and the voltage follow each other along the line**

### 1.3.2 Reflection from Various Discontinuities

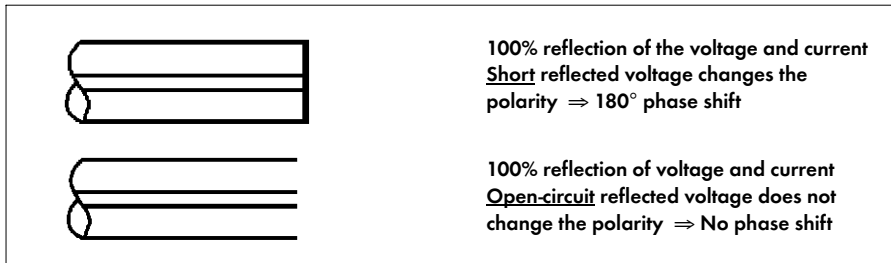

Figure 20 Reflection and shift by short and open circuit

A phase always will be zero at the source (reference).

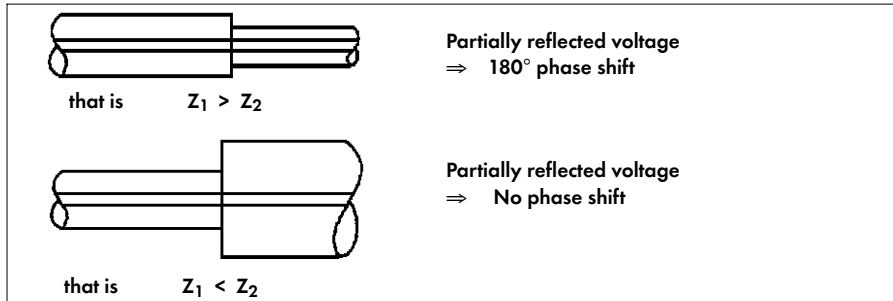

Figure 21 Phase shift as consequence of discontinuities

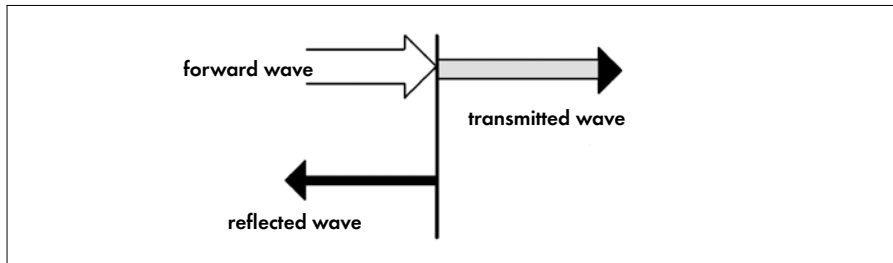

Figure 22 Waves reflected and transmitted at a discontinuity

- Every discontinuity creates a reflecting wave

- On a line with a discontinuity, 2 travelling waves are propagating:

The transmitted wave will continue forward and the reflected wave will return to the source.

RF line without discontinuities  $\Rightarrow$  Matched line

RF line with discontinuities  $\Rightarrow$  Mismatched line

The extent of the mismatch or discontinuity will be determined by the quantity of the arising reflections.



### 1.3.3 Terms for Definition of the Mismatch

#### 1.3.3.1 Reflection Coefficient $\Gamma$

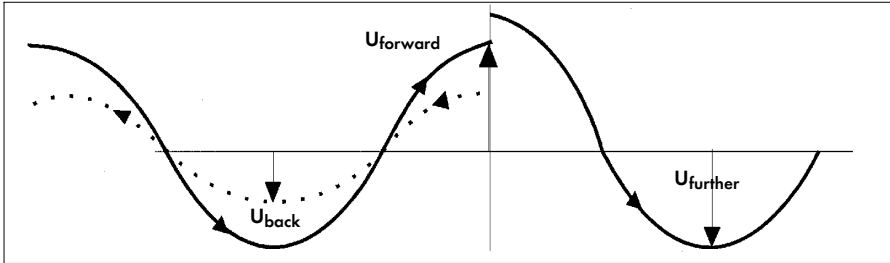

Figure 23 Reflected waves

$$\Gamma = \frac{U_{\text{reflected}}}{U_{\text{forward}}} \quad (14)$$

The reflection coefficient (factor) is the ratio of the reflected voltage to the forward voltage. For practical examples of reflection measurement, please refer to Chapter 4.

The reflection factor is usually expressed in %:

$$\Gamma = \frac{U_{\text{reflected}}}{U_{\text{forward}}} \times 100\%$$

**The coefficient expresses the amount or what percentage of the forward voltage is reflected.**

**Ideal line**  $\Gamma = 0$  (The factor should be as low as possible)

$\Gamma = 0\%$

**Short or open circuit**

$\Gamma = 1$

$\Gamma = 100\%$

Note: It is possible that  $U_{\text{reflected}}$  ( $U_{\text{back}}$ ) is higher than  $U_{\text{forward}}$ . This occurs when the impedance increases after a discontinuity (refer to Chapter 3.2 on page 63). This only applies to the voltage, the power will be lower.

**1.3.3.2 Return Loss  $R_L$**

$$R_L = 20 \log \frac{U_{\text{forward}}}{U_{\text{reflected}}} \text{ [dB]} \quad (15)$$

- further is:

$$R_L = 20 \log \frac{1}{\Gamma} \quad (16)$$

The return loss is a logarithmic measure of the reflection coefficient.

Normally, the return loss is related to the power and not to the voltage.

**The return loss is expressed in [dB] (decibel) and indicates the ratio of the transmitted power to the reflected power:**

**Ideal line**  $\Rightarrow R_L = \infty$  [dB] **(High return loss  $\Rightarrow$  no reflection)**

**Short and open circuit**  $\Rightarrow R_L = 0$  [dB] **The return loss should be as high as possible**

The return loss can also be defined when the impedance, before and after the discontinuity, is different:

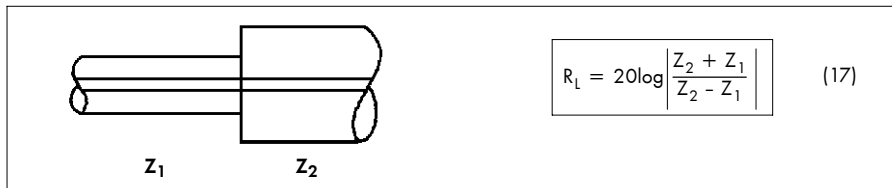

Figure 24 Change of impedance

Return loss	Reflected power in [%]	Reflected voltage in [%]
0 dB	100 %	100 %
3 dB	50 %	70 %
6 dB	25 %	50 %
10 dB	10 %	31.5 %
20 dB	1 %	10 %
30 dB	0.1 %	3.1 %

Table 3 Comparison of return loss to reflected power and voltage

### 1.3.3.3 Voltage Standing Wave Ratio VSWR

Along a mismatched line, two travelling waves will propagate:

One wave travels forward and the other is reflected. Both waves will have the same frequency. When the voltage is measured at a point of the line, a voltmeter will indicate the sum of the voltages of both travelling waves at this particular point:

$$\begin{aligned}
 U_{\text{sum}} &= U_{\text{forward}} + U_{\text{reflected}} & U_{\text{sum}}(s,t) &= U_{\text{for}}(s,t) + U_{\text{ref}}(s,t) \\
 & & s &= \text{distance } [\mu\text{m}] \\
 & & t &= \text{time } [s]
 \end{aligned}
 \tag{18}$$

This means that the travelling waves are added. It can be shown that this resulting wave does not actually travel along the line, but stands still. In other words: at any reference plane (points), there will always be a maximum or a minimum voltage. This wave is called a standing wave.

$$\text{VSWR} = \frac{U_{\text{forward}} + U_{\text{reflected}}}{U_{\text{forward}} - U_{\text{reflected}}}$$

(19)

$$\text{VSWR} = \frac{U_{\text{forward}} + \Gamma \times U_{\text{forward}}}{U_{\text{forward}} - \Gamma \times U_{\text{forward}}}$$

(20)

$$\text{VSWR} = \frac{U_{\text{max}}}{U_{\text{min}}}$$

(21)

When  $U_{\text{reflected}} = \Gamma \times U_{\text{forward}}$ :

$$U_{\text{max}} = U_{\text{forward}} + U_{\text{reflected}}$$

$$U_{\text{min}} = U_{\text{forward}} - U_{\text{reflected}}$$

(22)

$$\text{VSWR} = \frac{1 + \Gamma}{1 - \Gamma}$$

(23)

**The standing wave ratio is the ratio of the measurable maximum voltage to the minimum voltage along a homogeneous RF line ( $> \lambda$ ):**

**Ideal line** **VSWR = 1.0** **(The VSWR should be as low as possible)**

**Short circuit or open circuit** **VSWR =  $\infty$**

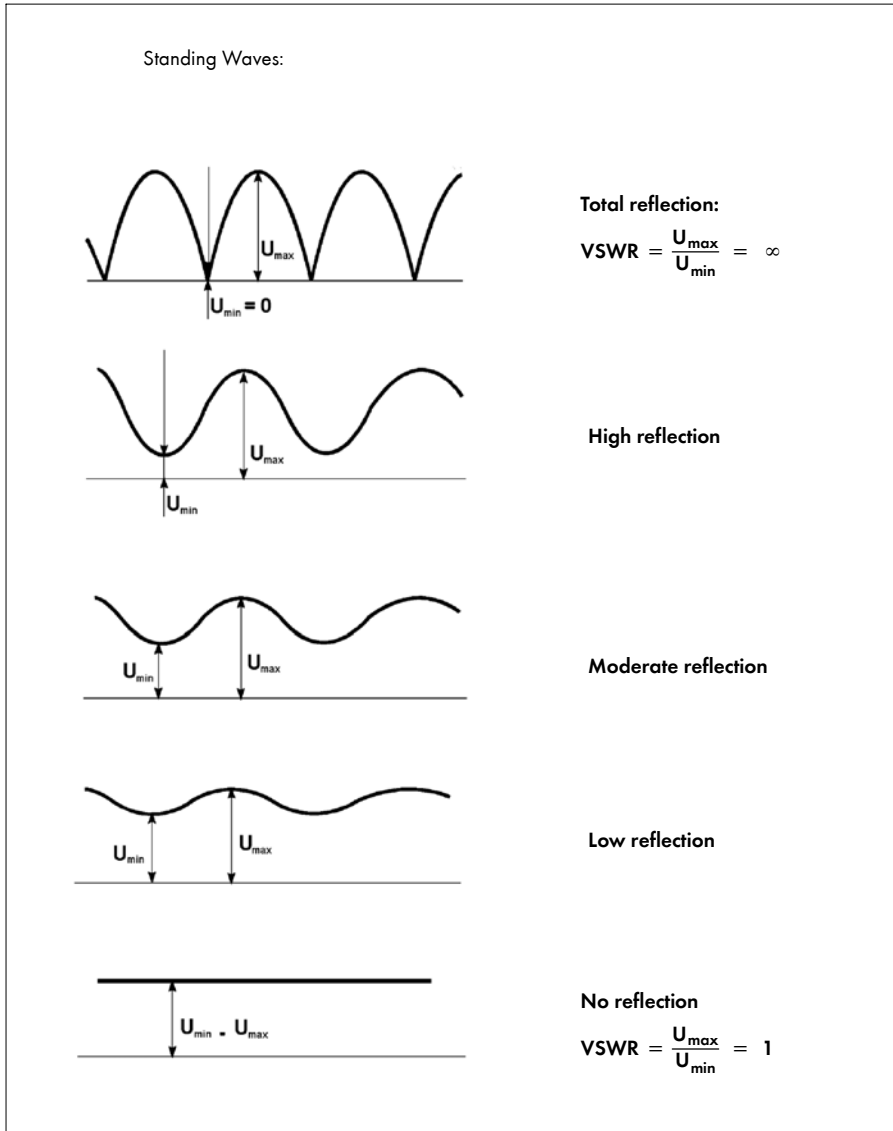

Figure 25 Various standing waves

### 1.3.4 Comparison between $\Gamma$ , $R_L$ and VSWR

Reflection Coefficient	VSWR	Return Loss
(24) $\Gamma = \frac{U_{\text{reflected}}}{U_{\text{forward}}}$	(25) $\text{VSWR} = \frac{U_{\text{forward}} + U_{\text{reflected}}}{U_{\text{forward}} - U_{\text{reflected}}}$	(26) $\text{RL} = 20 \log \frac{U_{\text{forward}}}{U_{\text{reflected}}}$
(27) $\Gamma = \frac{1}{\text{alog}\left(\frac{R}{20}\right)}$	(28) $\text{VSWR} = \frac{1 + \Gamma}{1 - \Gamma}$	(29) $\text{RL} = 20 \log \frac{1}{\Gamma}$
(30) $\Gamma = \frac{\text{VSWR} - 1}{\text{VSWR} + 1}$	(31) $\text{VSWR} = \frac{\text{alog}\left(\frac{R}{20}\right) + 1}{\text{alog}\left(\frac{R}{20}\right) - 1}$	(32) $\text{RL} = 20 \log \left( \frac{\text{VSWR} + 1}{\text{VSWR} - 1} \right)$

Table 4 Relationship between  $\Gamma$ ,  $R_L$  and VSWR (equations 24 through 32)

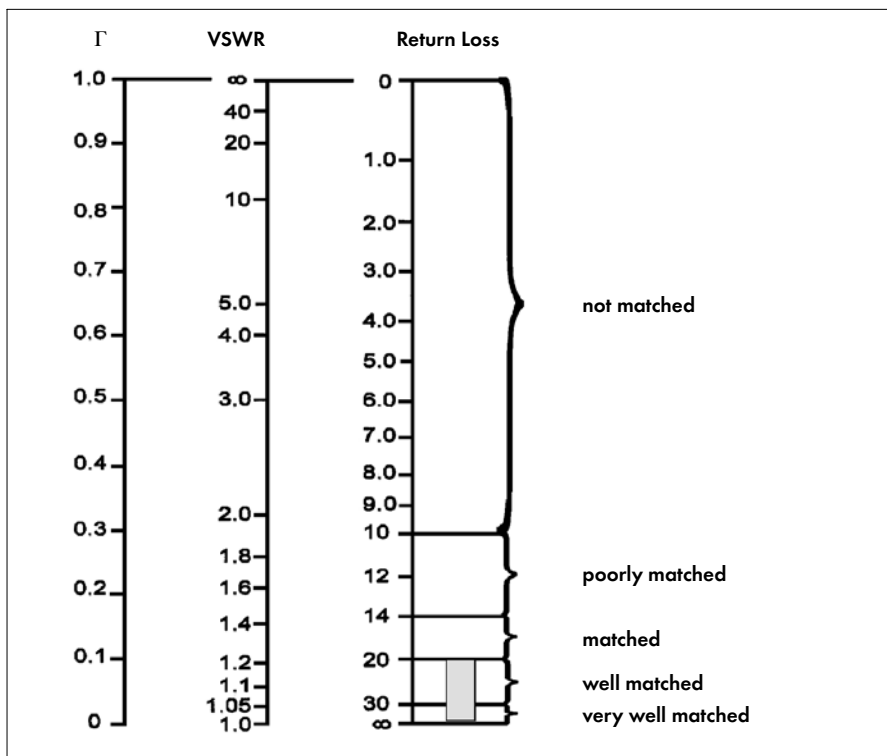

Figure 26 Table of comparison of magnitudes (refer also to the table in the formula booklet)

### 1.3.5 Reflection from two or more Discontinuities

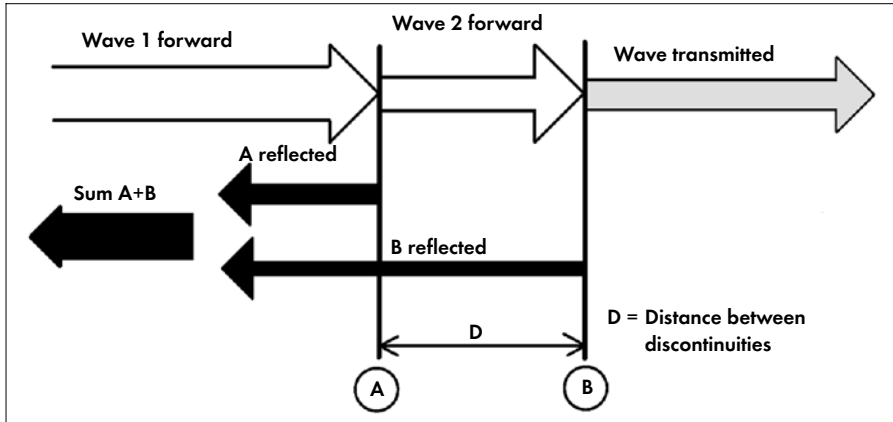

Figure 27 Reflections from several discontinuities

On lines with two or several discontinuities, two or more reflected travelling waves will propagate (see Figure 17 in Chapter 1.3 on page 22).

The absolute reflected signal is the sum of the reflected individual signals.

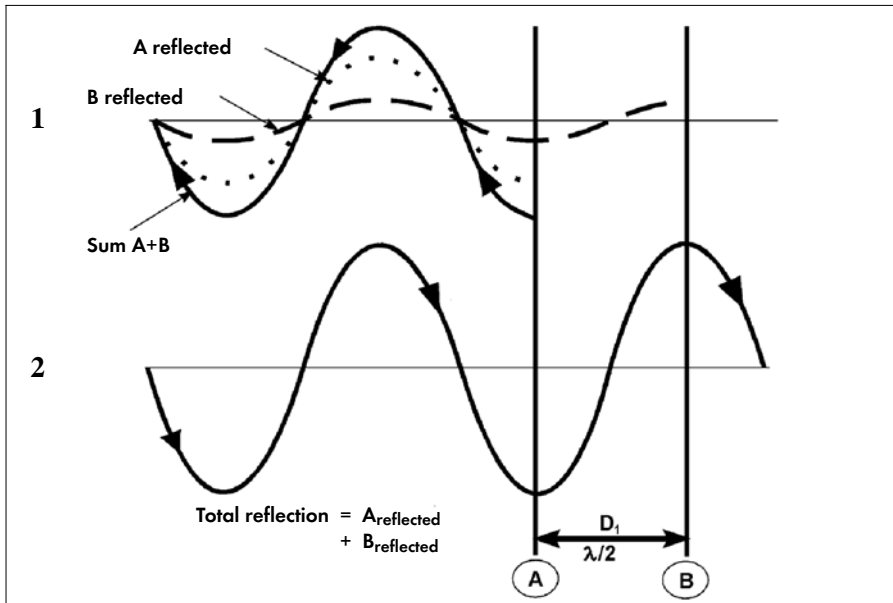

Figure 28 Two reflected waves (1) equivalent to total reflection (2)

With two or several discontinuities, the magnitude of the total reflected signals depends on the distance (e.g. in wavelengths) between the discontinuities.

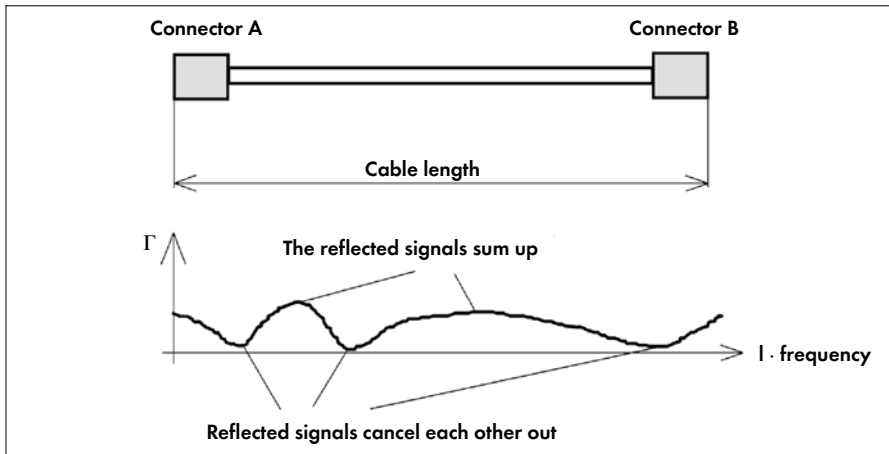

Figure 29 Reflected signals spread over cable length

## 1.4 ATTENUATION LOSS OF RF LINES

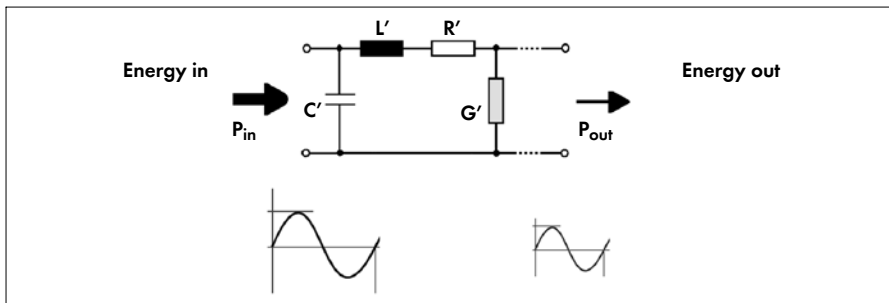

Figure 30 Attenuation loss (loss of energy) through the cable

The attenuation (or transmission) loss indicates how much energy is lost during the transmission of the signal through the RF line (Figure 30).

The three following factors influence these quantities:

- The electrical energy will partly be converted into thermal energy (heat), caused by the copper loss (skin effect) and the dielectric losses.
- Reflected energy is lost in transmitting direction.
- Leakage (poor shielding) causes radiative losses of the electrical energy.

### 1.4.1 Determination of the Attenuation Loss

$$\text{Attenuation} = \alpha = 10 \log \frac{\text{Power}_{\text{out}}}{\text{Power}_{\text{in}}} \text{ [dB]} \quad (33)$$

The transmission loss (attenuation) indicates how much lower the outgoing power is in comparison to the incoming power.

With the above equation (33), the value will be negative. To avoid confusion, the attenuation is often stated as a positive figure.

### 1.4.2 Attenuation Loss Components of Conductor and Dielectric

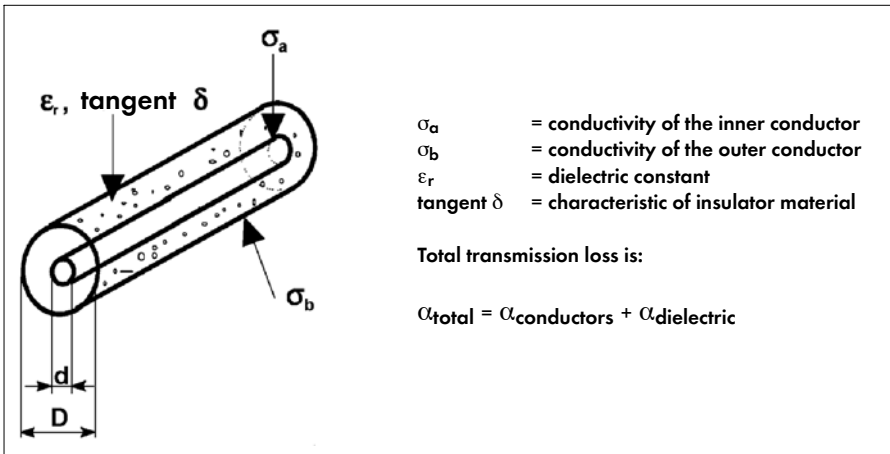

Figure 31 Attenuation loss components

The cable attenuation loss is the sum of the conductor losses (e.g. copper losses) and the dielectric losses.

$$\alpha_{\text{conductors}} = \alpha_c = \frac{11.39}{Z} \times \sqrt{f} \times \left[ \frac{\sqrt{\rho_{rd}}}{d} + \frac{\sqrt{\rho_{rD}}}{D} \right] \text{ [dB/m]} \quad (34)$$

$$\alpha_{\text{dielectric}} = \alpha_d = 90.96 \times f \times \sqrt{\epsilon_r} \times \tan\delta \text{ [dB/m]} \quad (35)$$

The constants are calculated with f in [GHz] and the diameter **d** and **D** in [mm].



$Z$  is the characteristic impedance in ohm  $[\Omega]$ ,  $\rho_{rd}$  and  $\rho_{rD}$  are the material resistivities of the conductor in comparison to copper. That is:  $\rho_{rd} = 1$  for a copper inner conductor and  $\rho_{rD} \approx 10$  for a steel outer conductor, because copper has a conductivity about 10 times better than steel.  $\delta$  is the skin depth, which is defined as the depth at which the current density is reduced to  $\frac{1}{e}$  or the equivalent thickness of a conductor at dc having the same resistance.

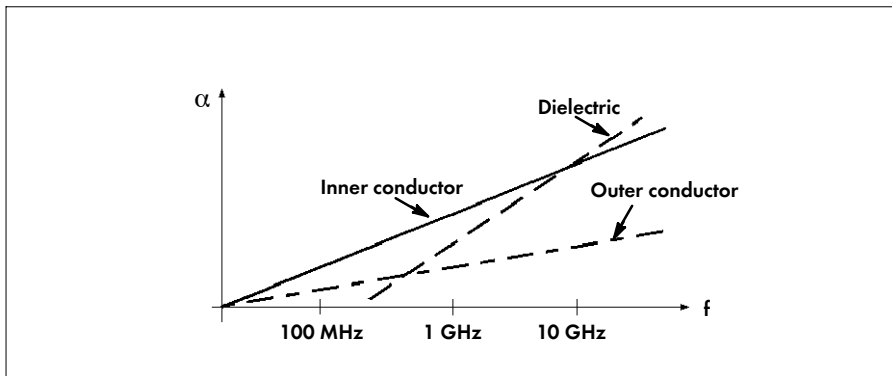

Figure 32 Attenuation loss as a function of the three cable components

A lower attenuation loss can be achieved by the following:

- A large cable diameter
- High conductivity of the materials
- Low dielectric constant

Up to about 10 GHz the conductor losses are dominant.

From about 10 GHz the dielectric losses are dominant.

### 1.4.3 Shielding

The goal of a good RF line is to maintain the electric and magnetic fields between the two conductors. Due to mechanical and manufacturing constraints, a 100% shielding is rarely feasible. Therefore, part of the energy can leak from the transmission line.

Except for radiating cables, the energy leakage is considered to be a loss. It causes interference (cross talk) or even errors in a system. The leakage is dependent on the frequency as well as on the physical construction of the line. To avoid high leakage, good shielding must be achieved by a fully enclosed dielectric.

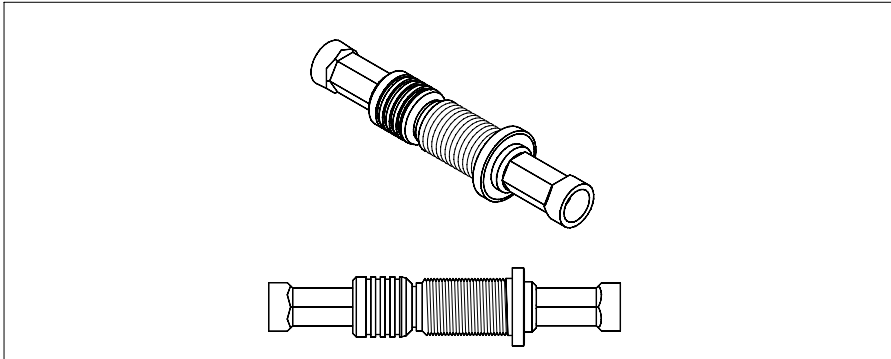

Figure 33 A simplified illustration of a shielded connector (RF leakage low)

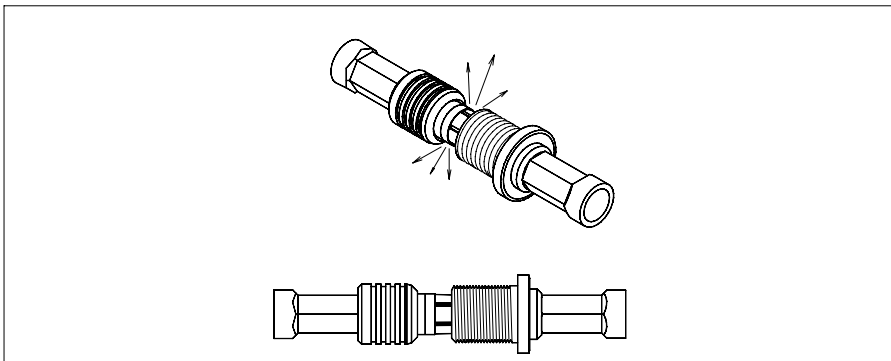

Figure 34 Example of the same connector, unshielded (RF leakage high)

#### Shielding means preventing

- unwanted electromagnetic energy from penetrating into the connector
- unwanted energy radiating from the connector (gaps)

#### Shielding Effectiveness (SE):

Determination of reduction in field strength resulting from placing a metallic shell between a source and receiver of electromagnetic energy.

## 1.5 THE SKIN EFFECT

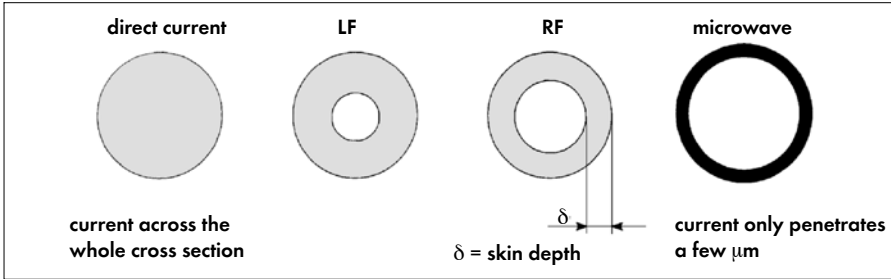

Figure 35 Skin depth at different frequencies

The ohmic resistivity of a metal conductor will increase proportionally to its DC resistance with an increasing frequency. This derives from the fact that current lines inside the conductor will be forced more and more towards the surface because of the magnetic inductance effect. On the other hand, a conductor, through which a direct current travels, shows a homogeneous current density across the whole cross section of the line. At very high frequencies the current does not stay inside the inner conductor and the outside of the outer conductor, but will flow in a very thin layer at the conductor surface (inner surface of outer contact, outer surface of inner contact). This state is called the skin effect.

**Wires carrying an alternating current tend to conduct the power only of the near-surface material**

Normally, at microwave frequencies, the major part of the current  $i_1$  flows at a depth of approx.  $3\delta$  (3 skin depths, which is equivalent to about 95% of the total current  $i_1$ ).

The skin depth  $\delta$ , in which approx. 37% of the current flows, is calculated as follows:

$$\delta = \sqrt{\frac{\rho}{\pi \times f \times \mu}} = \sqrt{\frac{1}{\pi \times f \times \mu \times \sigma}} \quad \begin{array}{l} f = \text{frequency} \\ \sigma = \text{conductivity} = \frac{1}{\rho} \\ \rho = \text{resistivity} \end{array} \quad (36)$$

$$K = \sqrt{\frac{1}{\mu_0 \times \mu_r \times \pi}} \quad \rightarrow \quad \delta = K \times \frac{1}{\sqrt{f \times \sigma}} \quad (37) \text{ \& } (38)$$

**K = factor for the medium**

**Example with copper**  $\rightarrow$   $\mu_0 = 4\pi \times 10^{-7} \text{ H/m}$  (permeability of vacuum)  
 $\mu_r = 0.99 \text{ H/m}$  (relative permeability for copper)

As approximation applies:  $\rho_{\text{Cu}} = 1.724 \times 10^{-8} \Omega\text{m}$  (Resistivity for copper at 27°C)

$$\sigma_{\text{Cu}} = 58.00 \frac{10^6}{\Omega\text{m}} \quad (\text{Conductivity for copper})$$

$$K_{\text{Cu}} \approx 503 \quad \rightarrow \quad \delta = 503 \times \frac{1}{\sqrt{f} \cdot \sqrt{58.00 \cdot \frac{10^6}{\Omega\text{m}}}}$$

$$= \frac{66 \mu\text{m}}{\sqrt{f} [\text{MHz}]}$$

All the following values apply to copper conductors:

Frequency	Skin depth
50 Hz	9.3 mm
$10^6$ Hz = MHz	0.07 mm
$10^9$ Hz = GHz	0.002 mm
$10^{12}$ Hz = 1000 GHz	0.07 $\mu\text{m}$

Table 5 Frequency vs skin depth

<b>High frequency</b>	$\Rightarrow$	<b>thin skin depth</b>
<b>High conductivity</b>	$\Rightarrow$	<b>thin skin depth</b>

## 1.6 PASSIVE INTERMODULATION (PIM)

The phenomenon of intermodulation has become a very widely used term in connection with the interaction sensibility in systems, especially broadband radiocommunication or cellular communication systems. And what is active versus passive intermodulation actually?

Active intermodulation is understood to mean the generation of mixed frequency products in transmission elements with non-linear characteristics (diodes, tubes, transistors). This is the case, for instance, when applying the signal of a local oscillator  $f_{\text{LO}}$  along with the signal frequency  $f_{\text{RF}}$  to the input of a component with non-linear characteristics in a radio receiver. By this, the intermediate frequency  $f_{\text{IF}}$  equalling  $f_{\text{RF}} - f_{\text{LO}}$  is obtained. However, numerous other signals are created in addition to this mixed product. In case of components with non-linear characteristics, the mixed products are often desirable and are purposely utilised.

$$f_{IM} = |n \cdot f_1 \pm m \cdot f_2| \quad (39)$$

(m and n are integers)

**Active intermodulation**  $\Rightarrow$  **Mixed frequency products in a transmission element with non-linear characteristics**

On the other hand, passive intermodulation (PIM) products are generated by the combination of two or more signal frequencies occurring in components theoretically having linear transmission characteristics, but whose behaviour is just as non-linear. Absolute linearity is only a mathematical ideal.

**Passive intermodulation**  $\Rightarrow$  **Mixed frequency products in components with assumed linear characteristics**

Whether active or passive products have any significance depends on the particular system and the components used. The instabilities of the intermodulation level, which may result from microscopic changes of individual parts in a system, are the greatest difficulty.

Example how to avoid passive intermodulation:

Only if each and every component in the system has been carefully designed and assembled with low-intermodulation behaviour in mind, and every threaded connection has been tightened under strictly defined conditions, it will be possible to achieve measuring dynamics exceeding 175 dBc (see PIM in the chapter on tests and measurements, page 126).

A measurement setup with stable characteristics alone will not solve the problems involved in PIM measurement. In order to classify the influence of intermodulation behaviour of a given component, it is important to find the worst possible intermodulation level in the whole system and not focus on the components with very little unstable behaviour.

The reason why PIM should be avoided: The interference (IM) arising, say, in mobile base station equipment could lead to a repeated or even continuous breakdown, meaning loss of connection or power cut.

### 1.6.1 Specifications

In mobile radio systems, several transmission channels exist in a single base system, and the transmission and receiving channels cannot be determined in advance. The third-order intermodulation products of these transmission channels may already fall into the receiving band, making the problem of passive intermodulation more acute than ever.

The specification limits for third-order intermodulation products in modern telecommunication systems are in general -100 to -150 dB related to the 2-carrier level sum (transmitting power), which has a magnitude from 20 up to 200 watts. However, the detection of intermodulation disturbances in systems and pinpointing of the error-contributing components at more than 150 dBc are nearly impossible, even under good laboratory condi-

tions. However, the signal ratios between the transmission power and intermodulation should be greater than 150 dBc. This is especially so in the field of antenna feeder measurements.

To meet such a requirement, all components must be designed, assembled and handled with extreme care (refer to chapter 3 on coaxial connector design, page 59).

<b>Desired system specification:</b>	<b>PIM</b>	<b>&gt; 150 dBc</b>
<b>HUBER+SUHNER specification:</b>	<b>PIM</b>	<b>≥ 155 dBc</b>
	<b>(dBc</b>	<b>= power ratio related to carrier = dBcarrier)</b>
	<b>(dBm</b>	<b>= absolute value related to 1mW)</b>

If large intermodulation products are to be avoided, there are a lot of factors to be aware about when designing and handling connectors. The table below shows just a few of the elements influencing the magnitude of intermodulation.

#### Some typical contributions to intermodulation products:

- Oxidized metal contact surfaces  
(caused by aluminium/other oxidative plating materials,  
but can be avoided by using silver instead)
- Ferromagnetic materials (steel, stainless steel etc. cause non-linear behaviour)
- Current saturation (current and voltage will cease to be a linear function)
- High corona level (plasma effect)
- Small cracks (occurring at the contact surfaces etc.)
- Oil or grease layers etc. (between the contact parts, not allowing pure contact)

Refer also to Chapter 4 on Tests and Measurements, page 109.



## 2 MATERIALS

CONTENTS	PAGE
<b>2.1 CONTACT MATERIALS AND PLASTICS</b> .....	<b>41</b>
2.1.1 Requirements and Design .....	41
<b>2.2 BASE MATERIALS</b> .....	<b>45</b>
2.2.1 Copper .....	46
2.2.2 Beryllium Copper Alloy .....	46
2.2.3 Phosphorus Bronze (Copper-Tin-Phosphorus Alloy) .....	47
2.2.4 Brass (Copper-Zinc-Lead Alloy) .....	47
2.2.5 Stainless Steel .....	47
2.2.6 Aluminium Alloy .....	47
<b>2.3 PLATING MATERIAL</b> .....	<b>48</b>
2.3.1 Gold .....	49
2.3.2 Silver .....	50
2.3.3 Nickel .....	50
2.3.4 SUCOPLATE) (Copper-Tin-Zinc Alloy) .....	51
2.3.5 SUCOPRO .....	51
<b>2.4 PLASTICS AND RUBBER</b> .....	<b>52</b>
2.4.1 PE .....	52
2.4.2 PTFE .....	53
2.4.3 PFA .....	53
2.4.4 PEEK .....	53
2.4.5 PPO .....	54
2.4.6 Silicone Rubber .....	54

## 2 MATERIALS

### 2.1 CONTACT MATERIALS AND PLASTICS

Within the chapter one in this booklet, materials or dielectric constants have been mentioned with regard to electrical or environmental performance. Choosing the base, insulating and interface (plating) materials in the beginning of the connector design process essentially defines the connector characteristics, determining how well the overall device or system will operate.

This chapter will cover descriptions and comparisons of some contact materials and plastics used for connectors and cables. The tables in Appendix 5.1 and 5.2 contain additional material specifications, for example electrochemical potentials and conductivity. They can help you choose the desired contact material for your connector application, or just for reference purposes of already chosen connectors.

#### 2.1.1 Requirements and Design

A contact material has varying combinations of properties, which make it difficult to select the best alloy to meet the requirements for a new contact application. Certainly, the designer must be aware of the characteristics and interrelationships dictating the material performance, available alloys, quality and cost effectiveness. In the design process, however, it is important for the designer to know why and how the material would influence the connector performance, but also how to meet the complex customer needs.

When a connector provides the contact between two devices of an electronic system, you expect it to carry through the signals without unacceptable distortion or power loss. The actual contact area between the two parts is significant in the signal path, as it is here that the electrical contact is maintained. In the contact area, changes in signal transmission arise directly or indirectly from the material related characteristics, listed below in Table 6.

The *surface smoothness* concerns the theory stating that the real surfaces are not perfectly smooth, which influences the size of the contact area (refer to Figure 36 below).

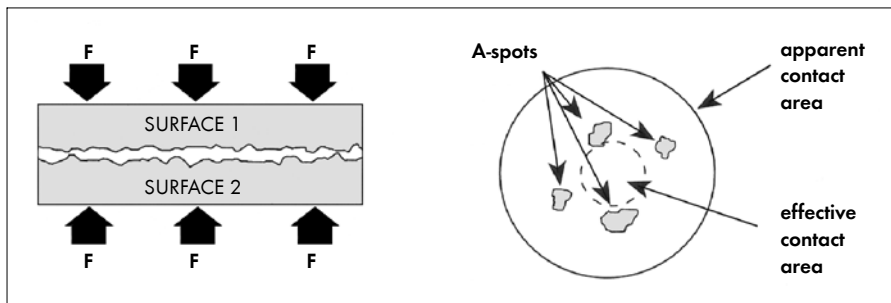

Figure 36 Contact theory (flat on flat surface) - microscopical view



The bulk surface consists of high and low regions, where only a few of the regions touch each other.

These spots are called asperities (A-spots or the high regions), providing the sum of the effective metal-to-metal contact spots under sufficient load (refer to Figure 36). The number, density and size of the A-spots vary. Their characteristics are dependent upon applied load (contact force  $F$ ), surface hardness, surface geometry and the presence of oxide or contaminant films on the surfaces.

Requirements	Influencing factors	Material characteristics
Mechanical	Surface smoothness	- Machining and plating
	Contact geometry	- Design and tolerances
	Contact force	- Elasticity of material - Heat treatment - Dimensions and tolerances
	Insertion and extraction forces	- Material fatigue - Contact finish - Dimensions and tolerances
Electrical	Bulk resistance	Conductivity/resistivity
	Contact resistance	Oxide film and contaminants
	Current capacity	Electrical and thermal conductivity
	Insulation resistance	Conductivity of the insulation
Attachment	Soldering	- Solderability - Bond strength - Solder - Heat stability - Dimension and tolerances
	Compliant pin (or PRESS-FIT)	- Formability - Spring force and strength - Dimensions and tolerances
	Crimping	- Formability (cold welding) - Springback - Strength - Dimensions and tolerances
System	Reliability	- Stress relaxation - Machinability - Solderability
Environmental	Corrosion resistance	Meteorological resistance
	Temperature, etc.	Temperature range

Table 6 Requirements and influences

The *contact geometry* is also a factor increasing or decreasing the effective or actual contact area. The design and contact form (see Figure 37 below) determine the size of the surfaces connected.

The contact points will produce infinite stress when they are concentrated on one or few spots. With the purpose of decreasing the contact stress, the contact force should be distributed over a greater surface area. The figure below shows examples of different geometric contact designs in order of increasing contact area and decreasing contact stress.

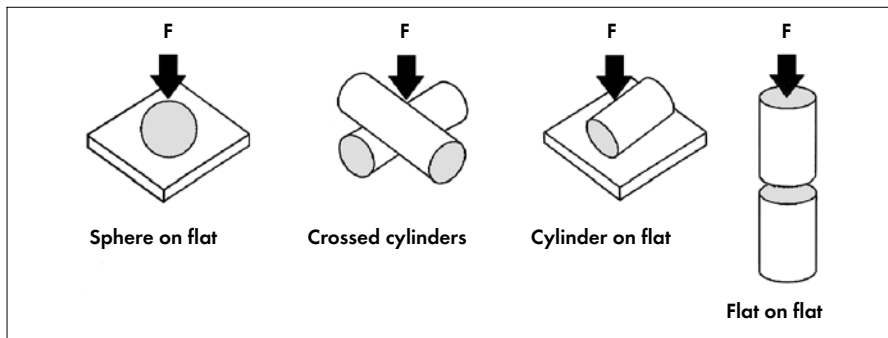

Figure 37 Contact geometry

The *contact force*  $F$ , as shown above, provides the contact between two surfaces. When the constant force enables the contact to maintain electrical integrity, the spring force of the material establishes the interface between connecting surfaces, thus avoiding the penetration of corrosive contaminants causing electrical instability.

The *insertion and extraction forces* (also called mating and demating forces) are directly proportional to the contact force and the coefficient of friction. When talking about insertion, the insertion cycles are important. The number of insertion cycles means insertions allowed before significant factors begin to change. Those factors can be wear, contact force, number of contact points, coefficient of friction and lead-in angle of the mating part and design requirements.

Low abrasion strength, low spring force and softness of the surface and spring material are four of the influencing properties which may reduce the quantity of the above-mentioned factors, thus reducing the number of insertion cycles. Some material will be worn off by mating and demating, which leads to a change of connector dimensions (tolerances increase). Finally, the contact force and other factors will be lower than specified.

The *bulk resistance* is the actual conductivity or resistivity of the material mass itself. The material chosen for the application should be able to transmit the load applied with minimum loss.

The *contact resistance*, a part of the total connector resistance, arises from the contact force, geometry (design and contact area) and surface characteristics of the connecting surfaces. It can be divided into bulk resistance, film resistance (oxide film) and constriction resistance ("narrowness" of A-spots). Please refer to Figure 38 below.

The film resistance between the contacts is built up of thin layers of "insulating" material, i.e. oxide film or contaminants. Only a minimum of the voltage will break through the film resistance. The constriction resistance is the sum of the A-spots which makes up the part resistance. The contact resistance is a function of contact or normal force.

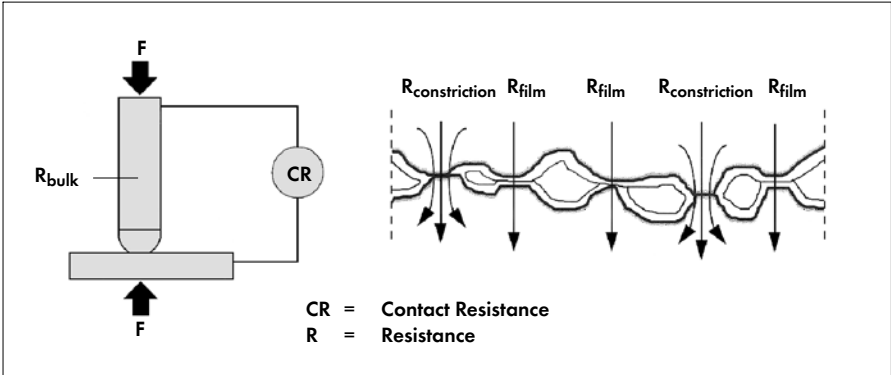

Figure 38 Contact resistance

Note: The above factors are called resistances, though the contact points might be regarded as conductive or positive to the transmission of current. It is a resistance because the material will always be a hindrance to the current flow, not neutral and not supporting. Otherwise, the theoretical ideal line without losses would be achievable.

The *current capacity* is the maximum current allowed for a given temperature rise. Base materials with higher conductivities (electrical and thermal) allow greater current flow with lower temperature rise, depending on the contact material, geometry and normal force.

The *insulation resistance* is the resistance to current flow, usually depending on the resistivity of the insulating material, e.g. a PTFE dielectric, in the connector.

The mechanical and electrical attachment of a connector to a PCB or a cable will be done by a solder, a press-fit or a crimp process. The *solder* attachment demands an excellent solderability of the solder-substrate (e.g. tin-lead plated solder legs) and plating (e.g. silver or SUCOPLATE). In addition, the temperature stability of the base material (e.g. beryllium copper) and the contact material at the solder-substrate interface must be high to avoid metallurgical changes.

The *press fit* process is a mechanical attachment which demands good formability features of the compliant pins, as a section will be deformed when pushed through the plated-through-hole on the PCB. A high material strength prevents buckling by insertion and good spring properties will provide reliability of the joint.

The attachment of cables to connectors (cable assemblies) usually requires a crimp tool to *crimp* (cold welding) the conductors together. The material that is crimped onto the connecting parts, i.e. the inner conductor of the cable to the inner contact of the connector, must be formable. The process of cold welding makes it possible to furnish an acceptable electrical and mechanical connection of crimps.

The *environmental* influences of a product play an important role when choosing a material for a certain application. The operating environment has specific characteristics such as temperature range, presence of vibration, shock and corrosive elements like gases and salt water emissions. The connector must be made of materials and to be designed so that can withstand these conditions without lacking any other property.

One of the critical steps in the design process is the selection of materials. The selection does not only depend on the connector itself, but also on the final attachment onto a panel, print board or to a cable. In addition, industry trends influence the design by requiring miniaturisation, higher operating temperature, faster operating speed as well as shorter development cycles, greater durability and lower prices. The flow chart of a typical connector design process is shown in Figure 39 below.



Figure 39 Design process

The choice of material should be done “methodically”, meaning isolation of the critical factors before designing the connector. The material properties should then be evaluated with the total requirements of the final application. This would help the engineer in designing a connector adapted perfectly to the customer’s needs. The disadvantage of overlooking these facts is that when a connector or a connector pair cannot perform as expected it may reduce the entire transmission system performance or even make it inoperative.

## 2.2 BASE MATERIALS

Base materials are important parts of radio frequency applications. They form the basis needed for an uninterrupted loop; they keep circuits from “cross talking”; and they create the boundaries for RF energy when used in coaxial lines.

We will be dealing with some of the most widely used alloys, such as beryllium copper and brass. Naturally, a huge number of other metals are available. There are especially many copper-based alloys, but we have chosen the range of materials below to be some of the most significant materials when good or excellent electrical, mechanical and environmental performance is required.

Base Materials are the basic materials of the connector components, before applying possible alloying. Selecting the proper material considers the following requirements;

- Good electrical conductivity (minimise bulk resistance, especially as frequencies go up)
- Machinability and ductility – easy and reasonable to shape, machine or form
- Good stability and tensile strength to withstand mechanical influences
- Good stress relaxation – resisting strain and elevated temperatures
- Hardness – reducing the wear deterioration of contact metallisation
- Reasonable price

### 2.2.1 Copper

Generally, copper is one of the most commonly used metals for conducting electrical signals due to its excellent electrical and thermal conductivity. The higher the conductivity, the greater the current flow will rise. For RF connectors and cables, however, copper is usually applied as an alloy base metal or an electrodeposited metal. The corrosion and chemical resistance of copper are fair to good, though the surface will turn black and form a green patina if exposed to sulphur compounds. The high melting temperature and the fairly high tensile strength (softer than brass) gives it excellent machinability. This can be achieved despite its tendency to smear; i.e. cold stamped or hot formed.

As mentioned above, copper is also applied as a plating. For obtaining a better adhesion of the final protective plating, copper is often deposited as plating flash on the base materials. That is one of the reasons why it has been a well-known silver-plated base material for coins through the ages.

Various connector and cable components: Crimp ferrules, wires and tapes. Copper is also used as final coating on cable aluminium wires.

Used as underplating on base materials: Steel, brass, aluminium zinc and copper-beryllium.

Underplating for final platings: Solder coatings and tin-nickel plate.

### 2.2.2 Beryllium Copper Alloy

As with copper, beryllium copper has a good electrical and thermal conductivity. It can be used unplated, because the corrosion resistance is good, except to ammonia and strong acids and bases. Strong bases and adverse environments can even cause stress corrosion cracking. The good thermal conductivity and very high tensile strength allow it to be exposed to high temperatures without risking melting and deterioration of other qualities.

This metal, typically named CuBe<sub>2</sub>, is an alternative to the pure or even silver-bearing copper, as it has a better corrosion resistance. Another difference between copper and beryllium copper is the lower electrical and thermal conductivity of CuBe<sub>2</sub>. Its machinability is better than that of copper, but not as good as that of brass. In addition, beryllium copper can be heat-treated and has excellent long-term spring characteristics. However, it is significantly more expensive than other materials used for contact parts.

Beryllium copper is used for the following connector components: Contact sockets (electrical contacts) and spring elements.

### 2.2.3 Bronze (Copper-Tin-Alloy)

Bronze is a combination of copper (Cu) and tin (Sn) including a few phosphorus and zinc compounds. This alloy is a quite soft metal, which only gets its strength from cold working, i.e. stamping and bending. Bronze can be an attractive substitute to other copper alloys because of the reasonably equivalent characteristics. This might be the case if the cost considerations of the product do not permit the use of beryllium copper, or when the technical specifications do not mandate CuBe.

Bronze is used for the connector components: Large contact sockets, resilient contacts and outer conductors.

### 2.2.4 Brass (Copper-Zinc Alloy)

The base metal brass is an easily machined material. The name "free-cutting brass" is derived from additives that cause chips in the machining process to break easily, thus preventing long tangles of chips that may disturb the final shape of the piece-part. As with beryllium copper, brass conducts thermal heat and electricity well. Furthermore, the resistance against industrial, marine and rural atmospheres and various oils is good; to sea water it is fair. Ammonia and acids will also attack brass.

Normally, brass is plated with either gold, silver or SUCOPLATE. The corrosion resistance and strength are improved by adding good metallic conductor materials which can meet these environmental and mechanical requirements.

Brass is used for the following connector parts: Housings, outer conductors and contact pins.

### 2.2.5 Stainless Steel

In the mechanical industry, steel and stainless steel are some of the most frequently used metals. Stainless steel, in the connector industry as such, is mostly used for applications requiring a hard metal, e.g. outer conductors. It is not extensively used for contact parts, as it has a low electrical conductivity and comparatively poor machinability. On the other hand, its high stability, high melting temperature and fair corrosion resistance are excellent characteristics, especially when the material is used for the outer component of a product, as e.g. a housing of a RF connector. Keep in mind that stainless steel is more difficult to machine than beryllium copper.

Usually, stainless steel is only used as base material for bodies and outer contacts.

### 2.2.6 Aluminium Alloy

Aluminium is rarely used in its elementary form but rather as an alloy. A typical representative is Anticorodal<sup>®</sup>, which is easily machined while retaining its self-protective characteristics. In addition, most connector applications using Anticorodal<sup>®</sup> do not require a plating.

Anticorodal<sup>®</sup> is a compound consisting of aluminium, magnesium, silicon and lead. Because of the high aluminium content, it has good electrical and thermal conductivity and a self-protecting property, an excellent oxidation resistance. It is a lightweight metal with high machinability, which is considered to be more cost-effective in certain applications and an alternative to more expensive and heavier metals as e.g. brass and even steel. A disadvantage is the low melting temperature, which limits the possibilities of using the metal in high temperature applications.

Anticorodal<sup>®</sup> components: Bodies, body parts for CATV connectors and components.

A short summary table of the base materials is shown below. The ratings can only be regarded as comparison averages due to the endless number of available alloys.

Features	Copper	Beryllium copper	Phosphorus bronze	Brass	Stainless steel	Aluminium alloy
Contact resistance*	++	+	+	+	-	+
Abrasion resistance	-	0	0	-	+	-
Discoloration	-	0	0	+	+	+
Price	+	--	+	++	-	-

Table 7 Comparison of common base materials

Note: Rating varies from ++ (excellent/very low price), + (good/low price), 0 (fair), - (poor) to -- (very poor/very high price).

\*Contact resistance should be as low as possible (++ = very low/excellent). Further properties: Refer to Appendix 5.2.

### 2.3 PLATING MATERIAL

The second topic in this section is plating. This booklet will confine itself to some frequently used metallic platings (interface materials), as these provide the best electrical conductivity, abrasion, etc., compared to e.g. well-known plastic coatings.

Metallic Plating usually has to:

- Add conductive material to supply sufficient current carrying capacity (good electrical and thermal conductivity)
- Diminish or eliminate surface oxidation and provide protective coating over conductors (such as copper alloy base metal) and resist cracking/spalling
- Provide good contact between conductors
- Achieve a good solder or weld attachment surface
- Obtain a better wear resistance (abrasion resistance and hardness)
- Provide interconnections from one conductive layer to another

(A rule-of-thumb for the choice of a plating or no plating at all is that normally pure, noble base metals do not need a plating, whereas most non-noble metals do. However, as connectors made of noble metal only would not be an economical solution, the noble metals are normally applied in thin layers on the non-noble base metals.)

Electrolytically deposited metals are not only applied to the base materials to make the components look shiny and attractive. These coating materials have very important influences on the electrical and environmental performance of the connector and cable items. HUBER+SUHNER has specialised in this technology and is a competent partner for developing and applying proper coatings for specific uses and conditions. SUCOPLATE and SUCOPRO were developed with the purpose of supplying platings which could resist oxidation and ensure a strong non-abrasive yet attractive surface for a reasonable price.

The above-mentioned plating features are typical characteristics of electrolytically deposited materials: High electrical conductivity, good wear resistance, low contact resistance and naturally good adhesion to the base material or the underplating. They are probably the four most important features, besides price of course, when choosing the right plating metal or combination for your application.

### 2.3.1 Gold

Gold (symbol Au) is a precious metal available both as a soft fine gold and a hard version. Gold is usually alloyed to give it more strength. It is a good conductor of heat and electricity and unaffected by air and most reagents, which makes it a superb material for electrical signal transmission. Another characteristic of gold is that it has a good machinability because of its ductility and high melting temperature.

The major use of gold in RF applications is for plating. Gold can be deposited on nickel or copper. Inner conductors are frequently gold-plated, when e.g. good conductivity, excellent oxidation resistance and continuous mating (repeatability) are required. Even in highly polluted atmospheres a gold surface is free of oxide. However, nickel is often deposited as under-plating to gold, because gold is quite expensive compared to other plating materials (see Figure 40).

However, sometimes gold plating is really the best metal to use for a particular application. When the connector is soldered onto a PCB surface, the nickel underplated gold legs (soft gold) provide a good solderable surface. The electrical performance of gold is also better than that of e.g. nickel underplated tin-lead legs, because gold has a better conductivity than tin-lead. However, the soft gold for solder applications has some disadvantages, as its wear properties are poor. It has a high tendency to smear and thereby it would function as a sort of "lubricant".

In some applications, i.e. military, space, etc., the designer might want to apply a thicker layer of gold as the base plate, which will then act as the ground plane for the connector line and provide high reliability. Whenever an excellent corrosion resistance, an untarnished surface and a constant and low contact resistance (i.e. no oxide film) are required, gold is the most suitable plating material. However, to minimise the cost of the connector, the thickness of the gold plating is usually kept to a minimum, or another suitable alloy is chosen. Some RF standards have even defined the minimum plating thickness of gold for some series to guarantee a good performance and thereby prevent suppliers from applying a thinner layer.

The disadvantages by making the gold plating as thin as possible are the risk of contamination (because of high porosity) and wear-through. Though gold is corrosion resistant, base metal spots would result in a diffusion of the base material to the surface and thereby lead to subsequent corrosion (refer to Figure 40, page 50). Base metal spots arise from porosity and wear the gold away (e.g. by repeated matings). Therefore – to avoid these disadvantages – the gold plating variation SUCOPRO can be offered (refer to chapter 2.3.5, page 51).



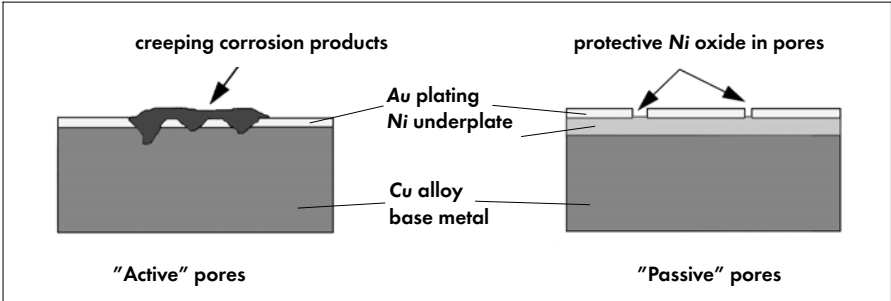

Figure 40 Pore corrosion – microscopical view

To avoid diffusion, nickel is frequently used as underplating, a so-called diffusion barrier, which slows down the speed of diffusion considerably. The nickel underplating can only be deposited on non-magnetic base materials because of the high relative permeability (refer to nickel on page 50). With the purpose of reducing the risk of wear-through and still retaining ductility, it is important to choose a thin gold plating with a moderate hardness.

Commonly gold-plated connector components: Inner conductors, springs and generally the bodies and outer conductors of PCB connectors (only for soldering).

Can be deposited on the following base materials: Copper, brass, nickel and silver.

**2.3.2 Silver**

The symbol for silver is Ag. This noble metal is often used for the plating of coins. Silver is a little harder but also somewhat cheaper than gold. Its excellent electrical and thermal conductivity makes it very suitable for surface plating. Silver is used in RF applications for making solder (plating) contacts. Having the best conductivity of all metals also means that this metal can carry a high current load with the least loss. This characteristic is particularly advantageous when a low passive intermodulation product is desired (refer to Chapter 1.6 on page 36).

The other features of silver are that it is easily shaped, has a very good conductivity of heat, good corrosion resistance in air and water and – in addition – the lowest contact resistance. A disadvantage is that silver tarnishes (creates an oxide film on the surface) when exposed to ozone, hydrogen sulphide and sulphur. Tarnishing can be slowed down by passivation.

Various silver-plated connector/cable components: Conductors, contacts and sleeves.

Can be deposited on the base materials: Most ferrous, non-ferrous metals, nickel and copper.

**2.3.3 Nickel**

The non-noble metal called Ni, nickel, is harder than gold, malleable, ductile and a fair conductor of heat and electricity. In RF applications, nickel is often applied as a coating material, but it is also widely used as an alloying constituent in stainless steel, other corrosion-resistant alloys and in coinage.

Commonly, nickel is used as underplate with top coatings of gold (see above) or other noble metals. Nickel is typically deposited in layers owing to its crystal structure, which makes it suitable as a barrier to copper diffusion through gold. Such a barrier prevents the migration of base material atoms to the top plating layer. Therefore, oxidation is effectively eliminated.

It has a fair electrical and poor magnetical characteristics. Its high permeability limits the use in applications where magnetic materials are not acceptable. Corrosion resistance is fair. Used as final plating material, the risk of flaking is fairly high due to the layered deposition of electroplated nickel. The flaking risk depends on the depositing process and the thickness of the plating. Besides, nickel has an unfortunate effect on sensitive skin, as it can provoke a nickel allergy by repeated contact.

Various nickel-plated connector components: Bodies and outer conductors.

Can be deposited on the base materials: Most ferrous and non-ferrous metals.

### 2.3.4 SUCOPLATE® (Copper-Tin-Zinc Alloy)

The plating material SUCOPLATE is a copper alloy composed of the three components: Copper, tin and zinc. Being non-magnetic and non-allergic (nickel free), SUCOPLATE is an attractive alternative for nickel plating, which generally has a lower electrical performance and lower corrosion resistance. The non-magnetic property in the contact area is also important for obtaining negligible passive intermodulation products (PIM) in communication systems such as base transceiver stations.

SUCOPLATE performs just as well as silver, that it has a PIM level of less than -155 dBc.

A low contact resistance of about 1 to max. 3 mΩ by mating can be achieved due to its low specific contact resistance. SUCOPLATED outer conductors leave a hard and abrasion resistant surface allowing more than thousand matings before the material is worn away. Usually the outer conductors have a silver plating under a SUCOPLATE flash. The silver with its high conductivity is able to carry most of the transmitted signal in the outermost surface of the conductor, as the frequency increases. For outdoor use, the good corrosion resistance of SUCOPLATE also guarantees a long lifetime, even in severe environments.

SUCOPLATE can be direct-contacted with nickel, silver and copper alloy base materials, without exceeding the maximum electrochemical potential of 250 mV. Furthermore, it has a consistent plating thickness distribution from the electrolysis process. In addition, it is a good substitute for silver plating, as SUCOPLATE is less expensive than silver.

Plating applications – SUCOPLATE only: Connector bodies and crimp ferrules.

Applications with silver as underplating: Outer conductors and current carrying parts.

### 2.3.5 SUCOPRO

SUCOPRO is a thin gold plating with a nickel-phosphorus alloy (13% phosphorus) underlayer. The gold layer – which is not subject to oxidation itself – protects the nickel-phosphorus underlayer against oxidation and thus allows for good wetting while soldering. It provides stable, low contact resistance and improved protection against oxidation and corrosion. Because it only contains a thin layer of gold, the solder joints will not become brittle.

The nickel-phosphorus layer provides very good corrosion resistance, high wear resistance and hardness, and a diffusion barrier against gold, copper, tin and zinc. Below 300 °C the NiP is amorphous and non-magnetic. Between 300 and 500 °C it changes its structure to microcrystalline and its hardness increases but no brittleness or weak adhesion occurs. At low temperatures (-20 °C) no changes of the soldering properties were detected.

The main advantages of SUCOPRO are:

- Excellent wear resistance
- Non-magnetic
- Excellent corrosion resistance
- Excellent wettability / solderability
- Very high strength of soldered joints without embrittlement
- Low contact resistance

Features	Gold	Silver	Copper	Nickel	SUCOPLATE®	SUCOPRO
Contact resistance	++	++	++	+	++	++
Passive PIM*	++	++	N/A	0	++	++
Residual magnetism	++	++	++	- -	++	++
Abrasion resistance	+	0	-	+	+	+
Adhesion	++	+	++	+	++	++
Discoloration	++	- -	-	- -	+	++
Price	- -	-	+	0	+	0

Table 8 Comparison of common plating materials

Note: Rating varies from ++ (excellent/very low price), + (good/low price), 0 (fair), - (poor) to - - (very poor/very high price).

\* PIM means the passive intermodulation product; ++ = very low (less than the required -155 dB). Refer also to Chapter 1.6. Further properties: Refer to Appendix 5.2.

## 2.4 PLASTICS AND RUBBER

### 2.4.1 PE

Polyethylene (PE) is one type of plastic from the big group of polyolefine plastics (e.g. polypropylene, ethylenevinylacetate). It has a low density, good electrical and dielectrical properties, which makes the plastic material suitable for RF applications. Its high water diffusion resistance, low water absorption and high resistance to chemicals (except oxidative acids) also provide the possibility of applying this material in adverse environments, without deteriorating mechanical or electrical properties.

Furthermore, it shows good machinability. It is soluble to varying degrees in halogenated hydrocarbons. Long outdoor storage can cause discoloration. The disadvantage of PE is its low melting temperature. When it burns, it will burn like wax. In other words, the material will drip by burning, but as it is halogen free, it will not emit any toxic chlorine or fluorine gases.

Other halogen free plastics are PE (PEX), LSFH (low smoke, free of halogen), SPE (foamed PE) and Radox by HUBER+SUHNER. Most of them can be crosslinked, thus increasing their flame resistance and form stability. As mentioned above, PE is also available in a foamed form (SPE), used mostly in RF cables.

Applications with PE: Turned insulators, wire and cable insulation, cable jacket material, corrugated cables and packaging.

### 2.4.2 PTFE

Polytetrafluorethylene (PTFE) is a fluorine plastic with an excellent resistance to most chemicals. However, it can be attacked by alkalines such as nitrous acids. It is very thermostable (from  $-200^{\circ}\text{C}$  to  $+250^{\circ}\text{C}/-392^{\circ}\text{F}$  to  $+482^{\circ}\text{F}$ ) and has a low flammability. In the beginning of the melting phase, at about  $+327^{\circ}\text{C}$  ( $+620^{\circ}\text{F}$ ) or higher, it will turn into a jelly-like substance.

In addition, it is an antistatic and a very anti-adhesive plastic due to its extremely low surface resistivity coefficient. The excellent electrical and dielectrical properties, independent of frequency and temperature range, are matched by a low modulus of elasticity, which makes it applicable for connector insulator. PTFE cannot be treated by the thermoplastic methods of injection moulding or extrusion because of its high viscosity. Instead, it is usually moulded (die pressure) in a cold state. It is one of the most well known fluorine plastics used for technical applications in the industry.

Applications with PTFE: Insulators, gaskets, anti-adhesive coatings.

### 2.4.3 PFA

PFA is a fluorine plastic like PTFE, and it is also similar to FEP (fluoroethylene propylene). The most significant differences between these three plastics concern their modulus of elasticity and lowest temperature. PFA has a lower elasticity (higher hardness and form stability) and a higher temperature limit than both PTFE and FEP.

As with FEP, PFA can be thermoplastically worked by extrusion and injection moulding. Furthermore, remoulding and welding are possible. Besides the high flame resistance, the remoulding process is only possible at high temperatures.

It has a good thermostability from  $-200^{\circ}\text{C}$  to  $+250^{\circ}\text{C}$  ( $-392^{\circ}\text{F}$  to  $+482^{\circ}\text{F}$ ) and good electrical conductivity. Its fair to good mechanical features include a high abrasion resistance and a good anti-adhesive performance, as with PTFE. PFA has an excellent resistance to most chemicals. The resistance to severe meteorological and atmospheric conditions is considered to be good.

Applications with PFA: Insulators, wire and cable jacket material.

### 2.4.4 PEEK

PEEK (or Polyether-Etherketone) is a heavy-duty plastic with a partially crystalline structure. It comprises excellent properties such as a high tensile strength, excellent form stability at high temperatures and a melting temperature of  $334^{\circ}\text{C}$  ( $633^{\circ}\text{F}$ ). The ability to resist chemicals, except for concentrated sulphuric acid, is comparable to PTFE, PFA and FEP. In addition, its high abrasion resistance and strength to withstand radiation, hydrolysis and moisture in any form enable the plastic to perform superbly in very extreme conditions. The crystalline structure also allows thermal remoulding of PEEK.

Its good electrical conductivity, very high strength and the fact that its weight is 30% of that of aluminium (when used for strengthening other materials) also make it suitable as an insulating material for cables exposed to high doses of radiation. Important for certain cable applications, PEEK is flame retardant and does not emit fumes or smoke.

Applications with PEEK: Radiation resistant wire insulation, wire coating, insulators.

**2.4.5 PPO**

Polyphenylene oxide (PPO) is an amorphous thermoplastic with an excellent resistance to hydrolysis, aqueous media such as detergents, acids and bases at high temperatures. On the other hand, PPO is not resistant to Ketone, chlorinated and aromatic hydrocarbons, which dissolve the material.

Its dielectrical features comprise excellent thermal conductivity and a negligible loss factor, barely influenced by external temperature, frequency or moisture. As with PEEK, PPO has a high temperature stability, but at a lower temperature than PEEK. Compared to PC (Polycarbonate), however, it has the same inflexible and tough structure, combined with high dimension stability at high temperatures. Additionally, its low water absorption enables PPO to be used in outdoor applications.

Applications with PPO: Thermal and electrical insulator parts, switch housings, covers.

**2.4.6 Silicone Rubber**

In RF applications, silicone rubber is exclusively used for gaskets. The material is soft and elastic due to the influence of caoutchouc (India rubber). The purpose of rubber gaskets in connectors is normally to seal against moisture or other contaminants. However, it is not resistant to chemicals such as acids, but to almost everything else. For uses where a high flame resistance is desired, silicone rubber can also be applied.

Applications with silicone rubber: Gaskets.

Features	PE	PTFE	PFA	PEEK	PPO	Silicone rubber
Elasticity	+	-	0	++	++	++
Hardness	0	+	++	++	+	
Discoloration	0	+	+	+	++	+
Water absorption	0	++	+	0	0	+
Abrasion resistance	+	++	+	++	+	-
Price	+	- -	-	- -	-	+

Table 9 Comparison of common plastics and silicone rubber

Note: Rating varies from ++ (excellent/very low price), + (good/low price), 0 (fair), - (poor) to - - (very poor/very high price). Further properties: Refer to Appendix 5.2 on page 138.



## 3. RF CONNECTOR DESIGN

CONTENTS	PAGE
<b>3.1 FUNCTION AND PERFORMANCE - IDEAL VS REAL</b> .....	<b>59</b>
3.1.1 Electrical Performance .....	59
3.1.2 Mechanical Performance .....	61
3.1.3 Environmental Performance .....	62
<b>3.2 COAXIAL CONNECTOR DESIGN</b> .....	<b>63</b>
3.2.1 Connection Types .....	63
3.2.2 Coaxial Connector Components .....	64
3.2.2.1 Inner Conductor .....	66
3.2.2.2 Outer Conductor (Outer Contact) .....	67
3.2.2.3 Insulator (Dielectric) .....	68
3.2.3 Contact Captivation .....	70
3.2.3.1 Captivation Techniques .....	72
3.2.3.2 Inner Conductor Captivation .....	73
3.2.3.3 Insulator Captivation .....	74
<b>3.3 COUPLING MECHANISMS</b> .....	<b>76</b>
3.3.1 Threaded Connection .....	76
3.3.2 Bayonet Coupling .....	76
3.3.3 Snap-On Coupling .....	77
3.3.4 Quick-Lock Coupling .....	77
3.3.5 Slide-On Coupling .....	78

<b>3.4</b>	<b>ATTACHMENTS</b>	<b>79</b>
3.4.1	Attachment of Cable Inner Conductor	79
3.4.2	Attachment of Outer Conductor to Cable	80
3.4.3	Attachment to Panel	81
3.4.4	Attachment to the Print Board	83
3.4.5	Assembly Tools and Instructions	84
<b>3.5</b>	<b>COAXIAL CONNECTOR SERIES AND CABLES</b>	<b>86</b>
3.5.1	Coaxial Connector Series	86
3.5.2	Coaxial Cables	87
3.5.2.1	Cable Design	87
3.5.2.2	Cable materials	89
3.5.2.3	Halogen-free materials	90
3.5.2.4	Material selection guide	91
3.5.3	Electrical Cable Performance	91
3.5.3.1	Impedance $Z_0$	91
3.5.3.2	Capacitance $C$	91
3.5.3.3	Cut-Off Frequency $f_G$ and Operating Frequency Range	91
3.5.3.4	Attenuation	91
3.5.3.5	Screening Effectiveness or Screening Attenuation $\alpha_s$	92
3.5.3.6	Velocity of Signal Propagation $v_R$	92
3.5.4	Cable Types and their Characteristics	92
3.5.5	Microminiature Connectors	93
3.5.5.1	Characteristics	93
3.5.5.2	Segments and Typical Applications	94
3.5.5.3	Typical Cables	94
3.5.6	Subminiature Connectors	94
3.5.6.1	Characteristics	94
3.5.6.2	Segments and Typical Applications	97
3.5.6.3	Typical Cables	98

3.5.7	Miniature Connectors	99
3.5.7.1	Characteristics	99
3.5.7.2	Segments and Typical Application	101
3.5.7.3	Typical Cables	102
3.5.8	Medium Connectors	102
3.5.8.1	Characteristics	102
3.5.8.2	Segments and Typical Applications	103
3.5.8.3	Typical Cables	103
3.5.9	Large Connectors	104
3.5.9.1	Characteristics	104
3.5.9.2	Segments and Typical Applications	104
3.5.9.3	Typical Cables	104
3.5.10	Precision Connectors	105
3.5.10.1	Characteristics	105
3.5.10.2	Segments and Applications	106
3.5.11	Within-Series and Between-Series Adaptors	106
3.5.11.1	Characteristics	106
3.5.11.2	Segments and Applications	106
3.6	STANDARDS	107





## 3 RF CONNECTOR DESIGN

### 3.1 FUNCTION AND PERFORMANCE - IDEAL VS REAL

As a transition from RF theory and an introduction to the practical design of a coaxial connector, a comparison of the ideal functions with the real, obtainable performance will be outlined as far as possible for each specification.

With reference to the chapter on theory, the ideal and basic functions of a connector can be defined as being:

- to conduct RF signals from a transmitter to a receiver with minimum losses and reflections
- to provide fast and repeatable mating and demating

When a RF connector is designed, the main goal is to minimize any departures from the ideal line with regard to costs, loss, reflection and dispersion. With optimum conditions it is called a homogeneous or an ideal RF connector. Usually this ideal performance cannot be achieved by looking at just one part of the connector characteristics. The factors influencing the performance include several electrical, mechanical, environmental, material and economic considerations.

Summing all the influencing factors, it is not reasonable and virtually impossible to manufacture an ideal RF connector, as it would have a very high price. When a special performance is required, a single connector is designed to its specific needs or application, so-called special products. Design of non-standard products will not be an issue here, as it is difficult to give practical examples without exceeding the purpose and scope of this booklet.

In the following, the general ideal and the real or obtainable specifications for RF connectors, with the associated problems/influences of reaching the ideal goal, will be outlined. The purpose is to provide a picture of some of the important considerations when designing a new connector. When an existing connector is modified, the change should not alter the specifications laid down by international or internal standards.

#### 3.1.1 Electrical Performance

The table below is an attempt to show the difficulty of determining ideal and real electrical specifications of a coaxial line. It should serve as a general view and guideline for the understanding of the actual electrical performance.

Electrical Specifications	Ideal Performance	Realistic Performance	Problems/Hints
Impedance [ $\Omega$ ]	$Z_0 \pm 0$ (e.g. 50 or 75 ohm)	$Z_0 \pm X$	Because of dimensional steps and other discontinuities, it is impossible to maintain homogeneity of $Z_0$
Frequency [Hz]	DC up to cut-off frequency $f_c$ (TEM)	The operating frequency (i.e. interface dimensions limit the frequency)	Dependent high attenuation, VSWR and mode changes
VSWR	1.0 (no reflection)	> 1.0	Reflections caused by any discontinuity
RF Leakage	Totally shielded (no leakage)	Up to 120 dB (frequency dependent)	Dependent on cable outer conductor (shielding) design and operating frequency
Insertion Loss	0 dB (No losses)	$\leq 0.5$ dB above cable frequency	The connector losses can be ignored
Dielectric Withstanding Voltage	> The cable breakdown voltage	Often smaller	Dependent on the ratio $D/d$ and dielectric
Working Voltage	> The cable breakdown voltage	Often smaller	Dependent on the ratio $D/d$ and dielectric
Insulation Resistance	$\infty \Omega$ (as high as possible)	$< \infty \Omega$	Dielectric losses, dependent on insulation material and dimensions
Contact Resistance	0 m $\Omega$	> 0 m $\Omega$	Contact forces, material characteristics (plating)

Table 10 Electrical Performance - Ideal vs Real

The real electrical performance depends on the performance of the attached cable, cable entry, geometrical connector dimensions, inner conductor captivation etc. The max. frequency of the coaxial line will adjust to the operating frequency of the weakest component in the line, because the influencing factors (see above) arise from all and not only from one component. Example: A connector has a frequency (e.g. 10 GHz) and high VSWR magnitude. The attached cable has operating frequency of e.g. 5 GHz, but a high attenuation arising from the length of the cable and perhaps apertures in the jacket causing leakage. The sum of all these factors will give the actual operating frequency of the whole line, and not just the cable alone, which represents the component with the lowest frequency level (refer also to Chapter 4.2 [page 113] on practical measurements).

### 3.1.2 Mechanical Performance

When it is not possible to obtain the desired or realistic mechanical performance for a new connector, the only guideline is the given standards. The task of designing a new connector, often based on non-standard enquiries,

will normally be supported by the existing standard connector dimensions, as it is more economical to reproduce standard parts than to develop and manufacture new ones.

Mechanical Specifications	Ideal Performance	Realistic Performance	Problems/Hints
Engagement force center conductor	= Disengagement force	> Disengagement force	Depends on roughness, sliding friction, deformation and spring contacts
Disengagement force center conductor	0 N	> 0 N	Dependent on magnitude of sliding friction
Coupling nut torque	Turn by hand and still obtain contact resistance approaching 0 $\Omega$	Proportional to interface dimensions	Dependent on RF leakage, if watertight, mechanical stability and engagement/disengagement forces
Contact captivation	No movement of the inner conductor in axial and/or rotational direction	Movements because mating forces are unavoidable	Due to deformations of the insulator
Durability	$\infty$ number of matings	$\approx$ 500 can be guaranteed (acc. to norm)	Dependent on material abrasion and spring contact relaxation
Cable retention force	> Cable stability	> Cable stability	Dependent on material abrasion and dimensions of connector and cable

Table 11 Mechanical Performance - Ideal vs Real

### 3.1.3 Environmental Performance

The environmental performance is very much dependent on the immediate surroundings of the application. In other words, a cable assembly in a laboratory will not be affected by climatic changes in the same way as an assembly in an outdoor application. Therefore, climatic classes have been created to classify the stress levels.

Environmental Specifications	Ideal Performance	Realistic Performance	Problems/Hints
Temperature range	> Application requirements	Dependent on material	Material changes Influence on performance
Climatic classes	> Application requirements	Dependent on material	Material changes Influence on performance
Thermal shock	> Application requirements	Dependent on material	Insulator characteristics and material
Moisture resistance/sealing	Watertight	Dependent on design	Material and design dependent Corrosion can lead to poorer electrical performance and risk of shorts
Corrosion	None	Dependent on surface and medium	Material characteristics Electrochemical potentials between material
Vibration	No negative effect	Dependent on mechanical stability	Coupling mechanism, e.g. contact interruption

Table 12 Environmental Performance - Ideal vs Real

Another factor which can be severe for an outdoor cable assembly is corrosion as the result of moisture and salt water influence. Corrosion often arises because of wrongly chosen plating and underplating materials. An example is connectors for use in mobile applications: The body plating should be a corrosion resistant material, i.e. SUCOPLATE from HUBER+SUHNER. This material is non-abrasive, non-magnetic and allows good transmission without high thermal and electrical losses (refer also to Chapter 2 on materials).

## 3.2 COAXIAL CONNECTOR DESIGN

### 3.2.1 Connection Types

Before we pass on to the design phase of coaxial connectors, it is important to define the existing connection types. The types listed below distinguish between internal and external connections. Basically, the connection is the place where the transmission of the signal occurs.

The reason why we show these interconnection groups is because the definition of the components to be connected must be clearly understood (refer to Table 13). In addition, their electrical and mechanical requirements are the specifications for determining the right type of connectors and perhaps the wiring/cablings of the system.

Con- nection Type	Application	Example (useful connectors)	
1	Connection inside component case (internal)	Connection of the integrated circuit to the socket, using e.g. re-flow soldering. (Bonded or housing connections; device to package interconnection)	
2	Connection from component to PCB or wire (internal)	Connection of a PCB connector to an integrated circuit, using soldering or a separable connection method. (Solder plugs or IC sockets; component lead to circuitry)	
3	Connection from PCB to wire or another PCB on a chassis (internal)	Connection between PCBs or PCB to a flat cable, using e.g. a solder, crimp or press fit attachment. (Press pins or DIN connectors)	

Table 13 Connection types



Connection Type	Application	Example (useful connectors)	
4	Connection from internal chassis to another internal chassis in the same housing, case, or cabinet (between subassemblies)	Connection of an enclosure to another subassembly, using i.e. a crimp or solder connection method (e.g. BMA connectors between subassemblies).	
5	Connection from one piece of equipment to another (external interconnect)	External connection from measurement equipment to an accessory, using e.g. crimp or snap-in attachments. (Connectors with flange)	
6	Connection from one system to another (external system wiring)	Connection between two systems with cable assemblies. (All cable connectors)	

Table 14 Connection types (cont.)

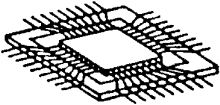
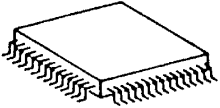
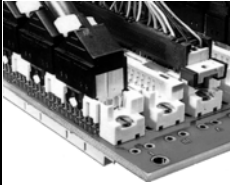
The focus will be limited to the shaded groups in the table above, as these groups are common fields for traditional coaxial connectors. The faintly shaded group 3 is partly described, as it uses PCB connectors. The connectors described in this booklet will only apply to the above-mentioned connection groups, and the selection of series dealt with is specified in Chapter 3.5 (page 85).

### 3.2.2 Coaxial Connector Components

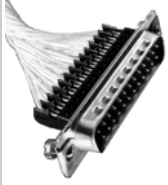
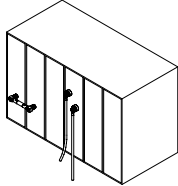
The reason for using connectors is either to join two components or modules, or to gain access to a certain point in a circuit. A connector's primary purpose is to provide an engagement/disengagement capability for your system (or circuit) without affecting a measurement in progress or the overall system's performance.

There are certain parameters which help to specify each coaxial connector type. Besides the impedance, the major areas of concern are upper frequency limit (cut-off), power capability, size and weight, environmental conditions (vibration, moisture, temperature), cost, field replaceability and contact characteristics, to name but a few. In addition, repeatability, life (mating cycles), VSWR and mechanical strength are important, if the connector is to be used for measurement applications. When designing a connector for using it in an application, the general requirement is to guarantee homogeneity along the finished RF line. The constancy of the characteristic impedance is the major aim when coupling lines with coaxial connectors. This requirement, often 50  $\Omega$  or 75  $\Omega$ , will be one of the factors giving the connector its shape.

Another precondition for obtaining the best possible design and performance is that of high precision piece parts. However, it is essential to keep in mind that the higher the manufacturing precision of the piece part, the better the characteristics, but also the higher the price of the finished connector (refer to Chapter 3.1 on page 59 ).

However, the size of the connector will also play a role in the choice of the manufacturing method. The smaller a connector is, the more accurately it has to be manufactured to achieve the same performance as a larger connector due to the ratio of the tolerances to the size.

A coaxial connector consists of several components. In this chapter the most important components and their variations, independent of specific series, will be shown and described individually.

The optimised coaxial connector will normally be built up of the elements shown below (Figure 41).

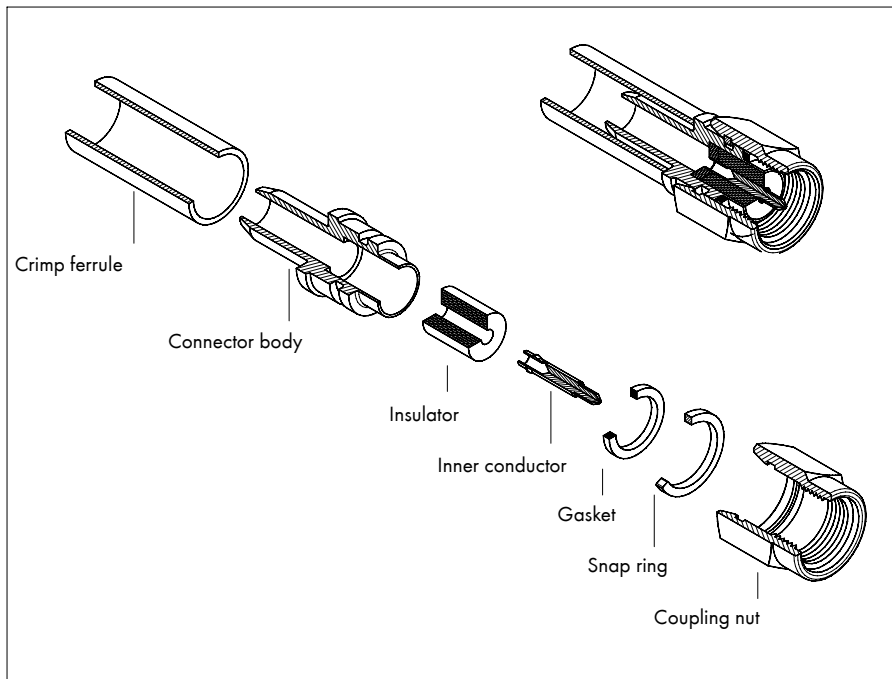

Figure 41 Connector components

The inner conductor (centre conductor), the connector body (outer conductor), the insulator and the crimp ferrule are the components discussed below.

### 3.2.2.1 Inner Conductor

Usually, we talk about two inner conductor contact types (also called centre contacts), radially bonded (pin and socket type) and butted contacts (hermaphroditic), respectively.

Radial bonding inner conductor: The connection is established by use of a pin and socket contact. The outer conductor generally is slotted and the inside one tapers slightly forward, increasing the tension as they are pushed together. This "wiping" action helps to clean the contacts as the connector is used.

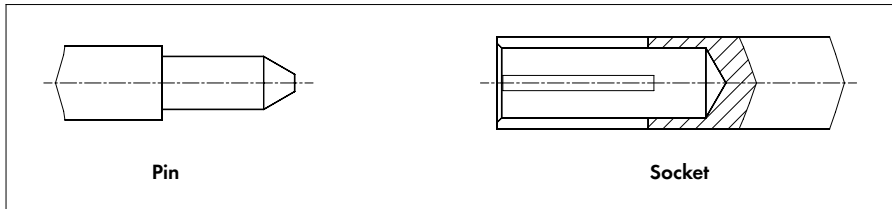

Figure 42 Radially bonded inner conductor



Figure 43 Butted contact inner conductor

### 3.2.2.2 Outer Conductor (Outer Contact)

The contact area of the outer conductor (also identical with the connector body) is effected by the contact pressure normally caused by the coupling mechanism.

Because the inner conductor can compensate for longitudinal tolerances, the contact pressure caused by the coupling mechanism affects the outer conductor contact area (torque of the screwed coupling mechanism).

There are three fundamental constructions:

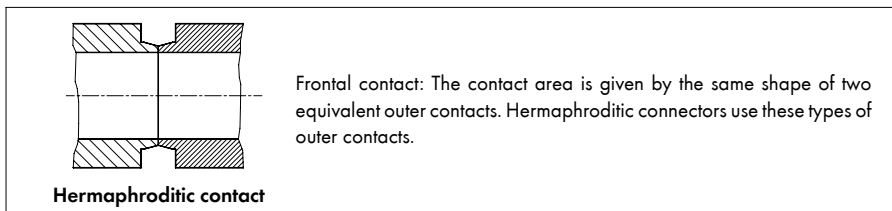

Figure 44 Hermaphroditic (frontally bonded) outer conductor

Radially contacted outer conductors with spring contacts: The spring contact contacts not only frontally, but also radially. The slotted outer conductor is used instead of the normal butt face wherever a better retention is required.



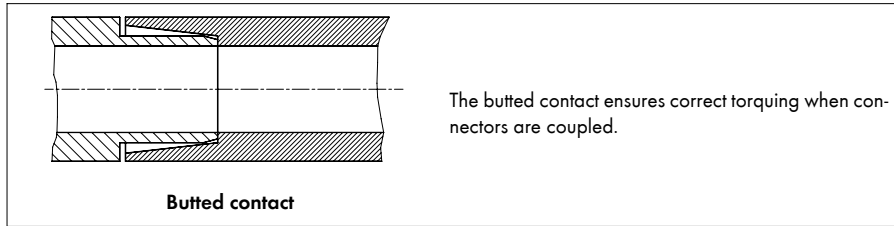

Figure 45 Butt faced outer conductor

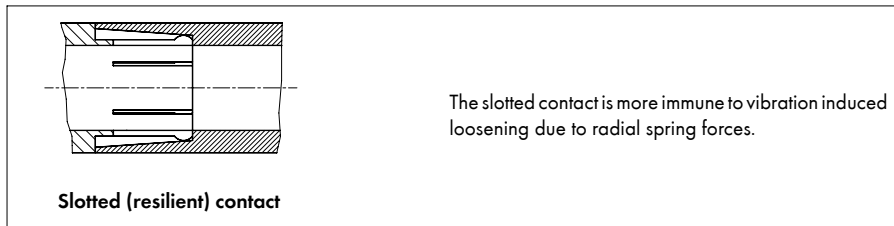

Figure 46 Slotted outer conductor

### 3.2.2.3 Insulator (Dielectric)

The insulator makes it possible to position the inner conductor within the outer conductor. From an electrical point of view, the ideal insulator material would be air, but special mechanical constructions are needed to keep the inner conductor in its central position. In order to make an economic positioning system, synthetic materials are used. To approximate air as closely as possible, the actual design of the dielectric support varies considerably.

The prime criterion for the choice of the synthetic material is the dielectric constant ( $\epsilon_r$ ). This number has a direct influence on the connector design and thus its impedance. To ensure an ideal dynamic system behavior, the connector must have the same impedance as the connected cable. This means that the mechanical dimensions and the insulator material must be chosen properly in order to have the lowest possible return loss.

There are about four different insulator combinations in a pair of connectors, dependent upon the desired contact.

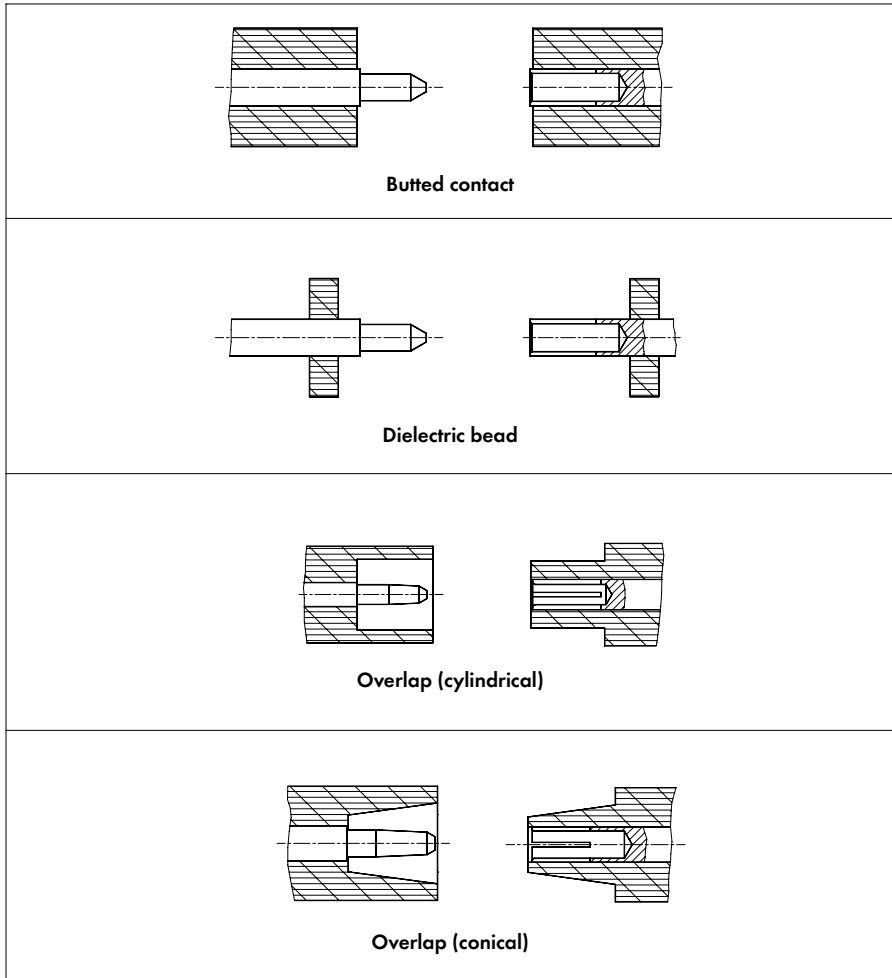

Figure 47 Butt, overlap (cylindrical and conical) and dielectric bead contact



Instead of a one-piece insulator, the possibility of mounting a two-piece is also available.

### 3.2.3 Contact Captivation

The captivation of components within a coaxial connector should exist for all types of connectors, but especially those for stripline and microstripline applications where the solder tag must be captivated. If un-captivated, the insulator could be displaced and the solder joint could be damaged by mechanical forces. If subjected to such influences, the connector should be stable to guarantee the specified mechanical and electrical standards.

This can be a difficult task, as the contact capture mechanism is usually obtained through geo-metrical changes of the optimized components. That is, the components are normally designed with the purpose of reaching the best possible electrical and mechanical performance and trying to diminish any negative influence such as discontinuities because of too many junctions.

The captivation design reduces axial, longitudinal, and/or rotational movements. However, the captivation should not be exaggerated, preventing any movement at all. This situation could lead to problems when mounting the contacts in the connectors and perhaps restrict any normal thermal expansion of the materials, causing over-tight contact junctions.

<b>Captivation = Capture mechanism:</b>	<b>Axial movements</b>  <b>Rotational movements</b> 
<b>Criteria, whether axial and/or rotational:</b>	<ul style="list-style-type: none"> <li>- Connection type (connection to external components, not cable)</li> <li>- Type of cable and cable entry</li> </ul>

Avoiding axial and/or rotational movements is not always desirable, as it is dependent on the connector type, the attachment to external and possibly non-stationary components. When cable connectors are concerned, the type of cable attachment is important (refer to Figure 58, Chapter 3.4.4). Therefore, the suggested captivation mechanisms cannot be directly related to series, only to connection types, cable entries and partly to the size of the connector, due to high costs, manufacturing and assembling considerations.

The displacements are mainly caused by external forces, temperature variations and shocks. The specifications of these axial forces, rotational torques and temperature ranges and of the corresponding test specifications are to a certain extent given by the international standards for every connector series.

With regard to the following table, the various connection types and cable entries require captivation in both or only one of the above-mentioned directions.

Attachment	Examples of Application/Usage	Axial Captivation	Rotational Captivation
Inner conductor - with solder tag - with slot - as pin contact - with tab contact	- PCB - Stripline - Microstrip - Bonded	✓ Important, to avoid damage of solder tag and stress at the contact joints	✓ Important, to avoid damage of solder tag and stress at the contact joints
Inner conductor - with soldering bore - with small post	- Wire soldering - Wire wrap	✓ To avoid damage of the wire attachment	✓ To avoid damage of the wire attachment
Inner conductor - with female contact type	- Field replaceable - Solderless connections - Plug-in connections	✓ To guarantee the electrical performance	-
Flexible cable attachment	- Flexible connections between components	✓ Generally important because of electrical and mechanical influence	- Mechanical stress on cables
Semi-rigid cable attachment	- Excellent electrical performance, hence low VSWR loss and negligible leakage	✓ Important for short cable lengths, because the inner conductor of the cable could be displaced due to thermal or mechanical influence	- Not required, because inner and outer contacts are normally soldered and/or crimped

Table 15 Axial and rotational contact captivation methods according to attachment

### 3.2.3.1 Captivation Techniques

Expressed simply, the inner conductor will normally be held by the insulator, and the insulator by the outer conductor. The inner conductor can be manufactured in such a way that the form of the conductor can be pressed into the insulator without damaging it. The alternative could be to change the insulator, but because of the smooth surface of the inner conductor it would not be possible to captivate it. When the shape of only one component is changed, there is a great risk that the other component will be unable to retain it. A combination of changes, adjustment of both components relative to one another, would be the best way to obtain a "doubly-secure" captivation.

However, the outer shapes of the components are not the only main factor to think about when choosing a contact capture mechanism for the connector. As with the problems of reaching an ideal performance (desired performance), there are lots of other influences.

#### Objectives influencing the selection of contact captivation design(s):

- Obtaining optimal electrical performance (acc. to standards)
- Obtaining optimal mechanical performance (acc. to standards) etc.
- Ease of connector mounting
- Costs of material and manufacturing of the mechanism

Before the advantages and disadvantages can be determined, the design options must be considered.

Several designs suitable for captivation of the inner conductor or insulator are shown below:

- Pressed-in parts
- Epoxy captivations (internal [insulator subassembly of housings] and bore through [insulator and centre pin])
- Barb(s)
- Straight knurls
- Crossed knurls
- Shoulder or step
- Dimple-captivation
- Internally stepped sections (3 or 4 steps made on the inside of the housing or outer contact)
- Swagings
- Ring with cams etc.

These mechanical designs are only one selection from among many. It is always possible to develop a new design, but often it is better and more economical to start with an analysis of the known and previously used designs.

### 3.2.3.2 Inner Conductor Captivation

The inner conductor must always be captivated in the axial (longitudinal) direction. The captivation technique also influences the dimensions of the insulator. This leads to discontinuities, causing impedance changes.

The figures and table below show some of the possible captivation designs. The designs are characterized without distinguishing between size and cable connectors, stripline and microstripline etc. The order of the axial and rotational capture, A and R respectively, depends on the most significant retaining direction according to the design (Table 16).

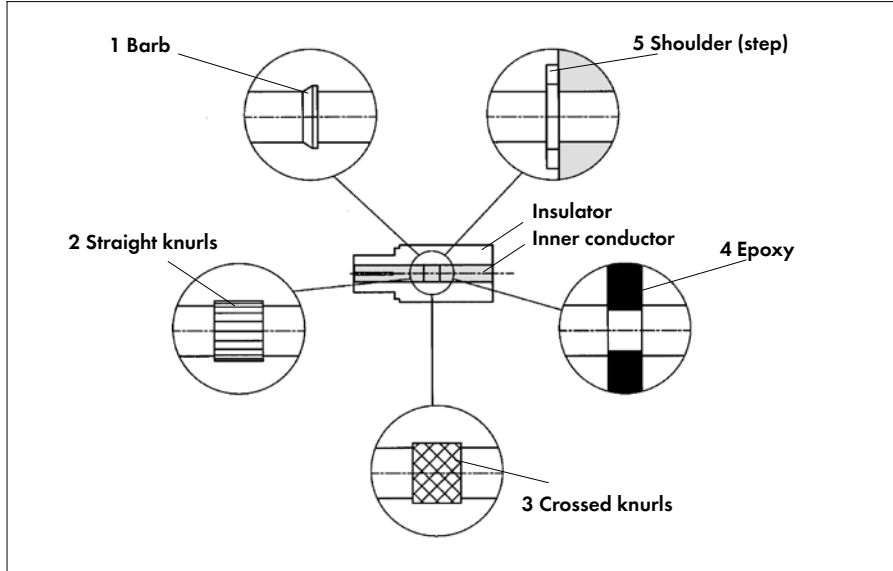

Figure 48 Various inner conductor captivation techniques

Inner Conductor Captivation	Axial **	Rotational**
1 Barb(s)	++	-
2 Straight knurls	+	++
3 Crossed knurls	++	+
4 Epoxy-captivation	++	++
5 Shoulder or step	++	-
Two-piece insulator*	+	-

Table 16 Captivation of the inner conductor

\* Captivation design not illustrated

\*\* Rating from ++ (excellent) to -- (poor)

### 3.2.3.3 Insulator Captivation

Sometimes the insulator captivation is referred to as the outer conductor captivation. This is incorrect, as the outer conductor will be designed with the purpose of retaining the insulator and not the outer conductor itself. However, it is correct to say that an outer conductor is the captivating component and the insulator the captivated component.

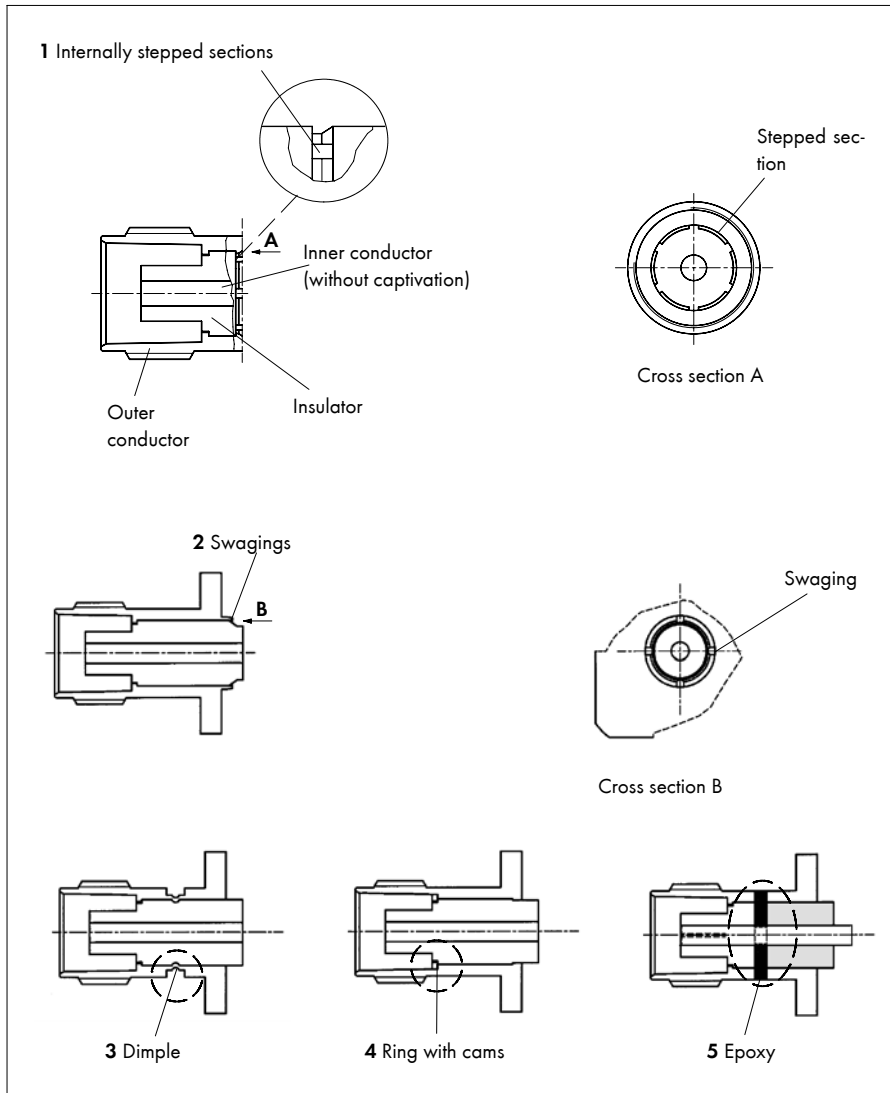

Figure 49 Various insulator captivation techniques

Insulator Captivation	Axial**	Rotational**
1 Internally stepped sections	+	++
2 Swaging	+	++
3 Dimple-captivation	-	++
4 Ring with cams	+	++
5 Epoxy-captivation	++	++
Pressed-in insulator*	+	-

Table 17 Possible insulator captivations

\* Captivation design not illustrated

\*\* Rating from ++ (excellent) to -- (poor)

As shown above, the choice of design depends on both the connector designs and of course the purpose of the captivation. If capture in both directions is required, it might not be sufficient to choose only one design. A combination of two designs, with axial and rotational captivation respectively, would be necessary.



### 3.3 COUPLING MECHANISMS

Coupling mechanisms make it possible to mate connector pairs and also determine whether or not the mated pair can meet the specified mechanical and electrical characteristics such as operating frequency.

The following four types of mechanisms are commonly used for the series described in this booklet (refer to Chapter 3.5 on page 85).

#### 3.3.1 Threaded Connection

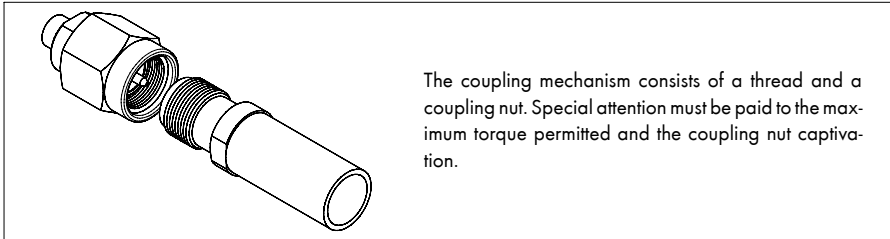

Figure 50 Threaded coupling mechanism

The threaded connection is slow but reliable (especially in severe vibration environments) and used in all series of SMC, SMA, TNC, N and 7/16, because the mechanism guarantees the most stable, stationary coupling. It is suited for Test and Measurement, Military and Telecom applications.

#### 3.3.2 Bayonet Coupling

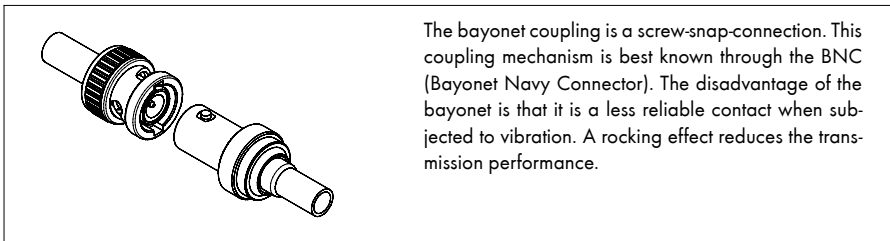

Figure 51 Bayonet coupling mechanism

The bayonet connection is often chosen when fast mating and demating is required. Therefore, the mechanism is reliable for test and measurement applications as well as military systems. Used in the series BNC, BNT, SHV and MHV.

### 3.3.3 Snap-On Coupling

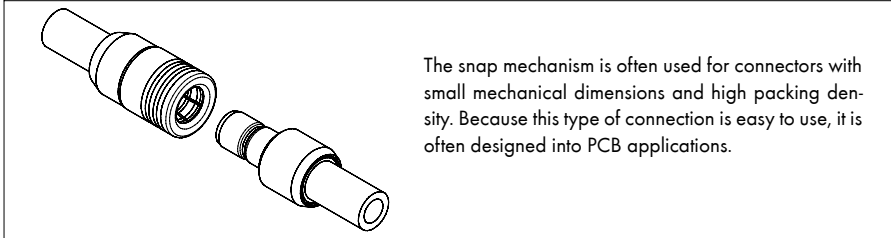

Figure 52 Snap-On coupling mechanism

The main feature of the Snap-On mechanism is that it allows extremely quick engagement and disengagement. This mechanism is very reliable when used for small connectors such as MMBX, MMCX, SMPX, MCX and SMB series.

### 3.3.4 Quick-Lock Coupling

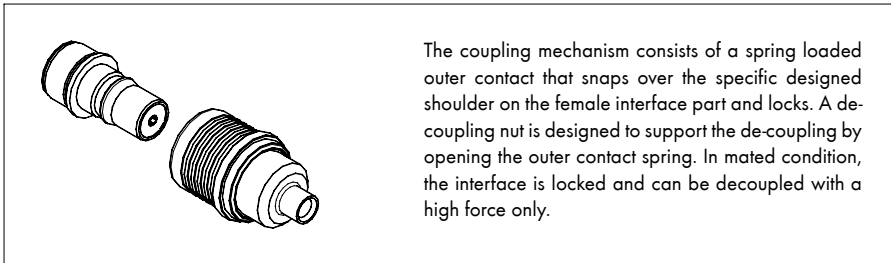

Figure 53 Quick-Lock coupling mechanism

The Quick-Lock coupling mechanism combines the advantages of an excellent electrical performance known from threaded interfaces, with fast and time-saving coupling and de-coupling operation similar to a snap-on interface. QMA and QN are the known Quick-Lock interfaces available as an alternative to the corresponding threaded interface in a frequency band up to 6 GHz.

### 3.3.5 Slide-On Coupling

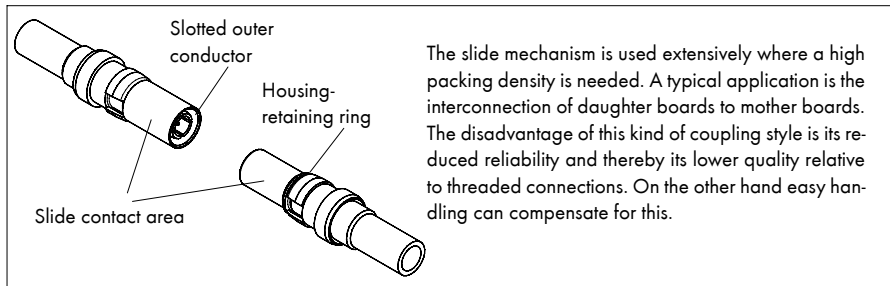

Figure 54 Slide-On coupling mechanism

This mechanism is often used for various DIN multi-connectors and also in miniature connectors such as BMA, SMS and 1.0/2.3 (shown in Figure 54). The 1.0/2.3 can also be used in a DIN housing. This is retained by use of a snap ring.

## 3.4 ATTACHMENTS

The connection between a connector and an external element is made by an attachment, either with a cable, soldering to a PCB, panel feed-through or with another connector, e.g. an adapter. These connections can be compared with the connection types in Table 14 in Chapter 3.2.1 on page 63.

In the following, the attachment methods and their purposes and usefulness to the individual components will be described and illustrated.

#### The most common attachment techniques for coaxial connectors:

- Plugging
- Soldering
- Crimping
- Clamping
- Pressing
- Threaded

Usually, connectors have to be designed to withstand severe forces such as those caused by the cable. Because the conductors should not be affected by these forces, the coupling mechanism itself has to be able to withstand them. Not only the forces, but also the surroundings and environmental conditions may be criteria for the selection of the right attachment, especially cable attachment.

### 3.4.1 Attachment of Cable Inner Conductor

The inner conductor of the cable must have contact within the connector. This can be achieved by plugging the cable conductor directly into the connector centre contact. The connector conductor acts as a jack and the cable conductor as a plug. The plugged type is a loose and quick attachment and suited for applications where repeatable electrical performance (usually required for connectors in the GHz range) is required. The contact is not influenced by extreme temperatures and is less susceptible to displacement compared to the other methods.

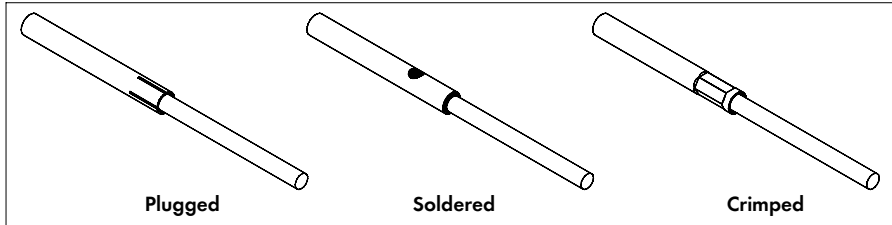

Figure 55 Attachments of the inner conductor

Soldering is an alternative technique commonly used for the attachment of semi-rigid cables and small flexible cables, where the attachment of the outer conductor is crimped, clamped or soldered. The advantages of this method are that the contact resistance is low and the solder joint at the inner conductor does not need to be soft-annealed in advance. Although fairly reliable, soldering is a slow attachment technique, which must be carried out carefully. When soldering, the temperature influence on the cable dielectric is very high and additionally, too much solder flux may form small beads at the surface. Proper cleaning is an essential part of the soldering process.

The crimp technique allows a fast and also reliable attachment and does not require any special skills. With regard to the crimping process, the factors described in Chapter 3.4.2 (page 78) have to be taken into account. There is no temperature influence, but the electrical performance of this method is reduced compared to the above-mentioned methods.

### 3.4.2 Attachment of Outer Conductor to Cable

The outer conductor can be attached to the cable in various ways. However, an important parameter not to be ignored is the cable size and the required cable retention forces. For optimal electrical performance, the connector and the cable dielectric diameters and sizes should always correspond to each other, thereby minimizing changes in diameter in the transition between cable and connector.

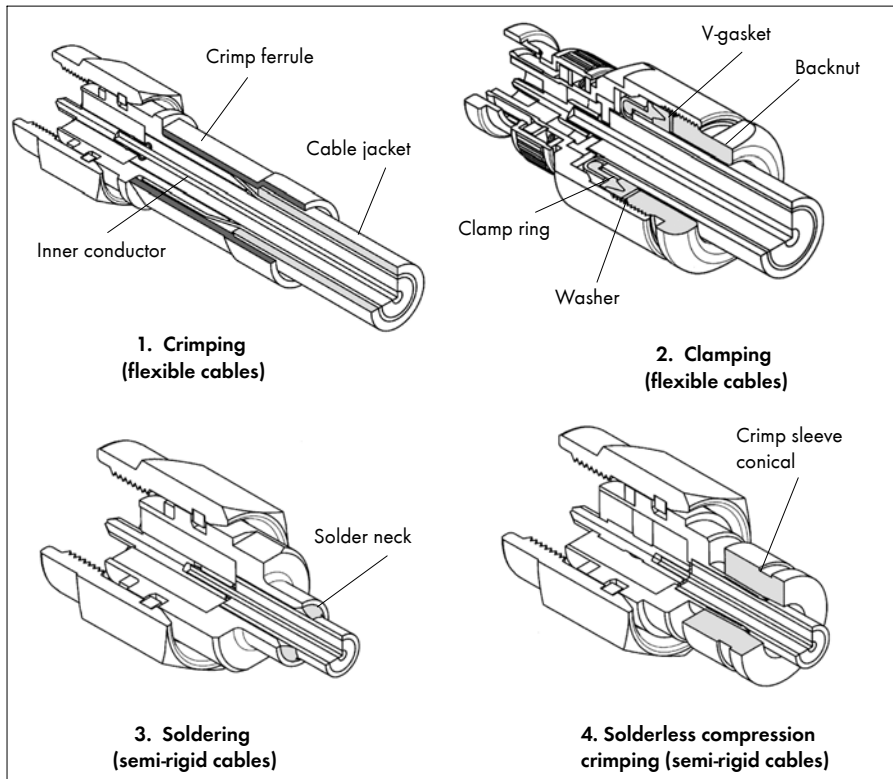

Figure 56 Attachments of the outer conductor

Crimping (1 and 4) is used whenever a quick and easy 3-piece attachment is required. The main disadvantage of this termination method is that it is not reusable. For a crimp joint, a crimp ferrule is necessary. The braid of the cable is positioned between the connector body on the inside and the crimp sleeve (ferrule) on the outside; a crimping tool then secures the connection. Normally, moisture protection is not guaranteed by crimping, but if this is required, a heatshrink tube with hot melt adhesive can be mounted to cover possible gaps between the ferrule and the connector. (Referring to Figure 41, Chapter 3.2.2 [page 64], where the crimp ferrule is the component enabling the cable to attach to the cable connector). If no ferrule is used, a conical sleeve normally would replace it.

The crimp ferrule has to be made out of a soft material (i.e. copper with SUCOPLATE or gold plated), allowing the crimp die to remould but not damage the form. Crimping is a "squeezing" or cold welding of the ferrule onto the pre-assembled connector. (Please refer to the HUBER+SUHNER Coaxial Connectors General Catalogue).

The ductility of SUCOPLATE makes it an ideal plating material for this demanding application, where significant shape changes take place.

The crimp ferrules used by HUBER+SUHNER are made so that they are perfectly suited to a certain cable group and connector. All ferrules have a wall of varying thickness. That is, the outer diameter does not vary within a

cable group, only the inner diameter with the purpose of adjusting it to the cable. This reduces the number of necessary crimp inserts (refer to Chapter 3.4.5 on page 83).

To ensure a good crimp, the crimping forces and dimensions and the ferrule itself must remain constant. This can be obtained by using calibrated crimp dies with test components, which can reproduce exactly the same crimp action with the same force, without damaging the ferrule or making the attachment too weak or too strong.

This method of assembly offers several distinct advantages over the clamping technique - cost is reduced, more uniform assemblies are obtained because of a straightforward process and a greater retention strength.

Clamping (2) refers to a back nut with a rubber gasket, where the inner conductor is soldered. This method is very useful for weather-exposed applications, because the rubber gasket protects against moisture. However, clamping is a much slower attachment with a better electrical contact compared to crimping. This technique is also called solder-clamp.

Another method is that of soldering (3) the outer conductor to the cable. This can be used for semi-rigid cable attachments and be combined with a clamp method for larger cables. A low temperature solder is employed to ensure a good mechanical and electrical connection. To guarantee a good solder joint it is important to control the process with special tooling (Chapter 3.4.5 on page 83). Another possibility of soldering attachment is used for connectors without pin and insulator. The technique is called solder-solder. Using this soldering method, the inner conductor and the insulator are the actual cable centre.

### 3.4.3 Attachment to Panel

Whenever a connection from or to an instrument/chassis is needed, the attachment of the connector, adapter or cable assembly is made to the panel. Therefore, these types of attachments are called panel-mounts. In this chapter, we have chosen to describe four commonly used fixation techniques to panels; bulkhead (threaded), flange, hermetically sealed and field replaceable.

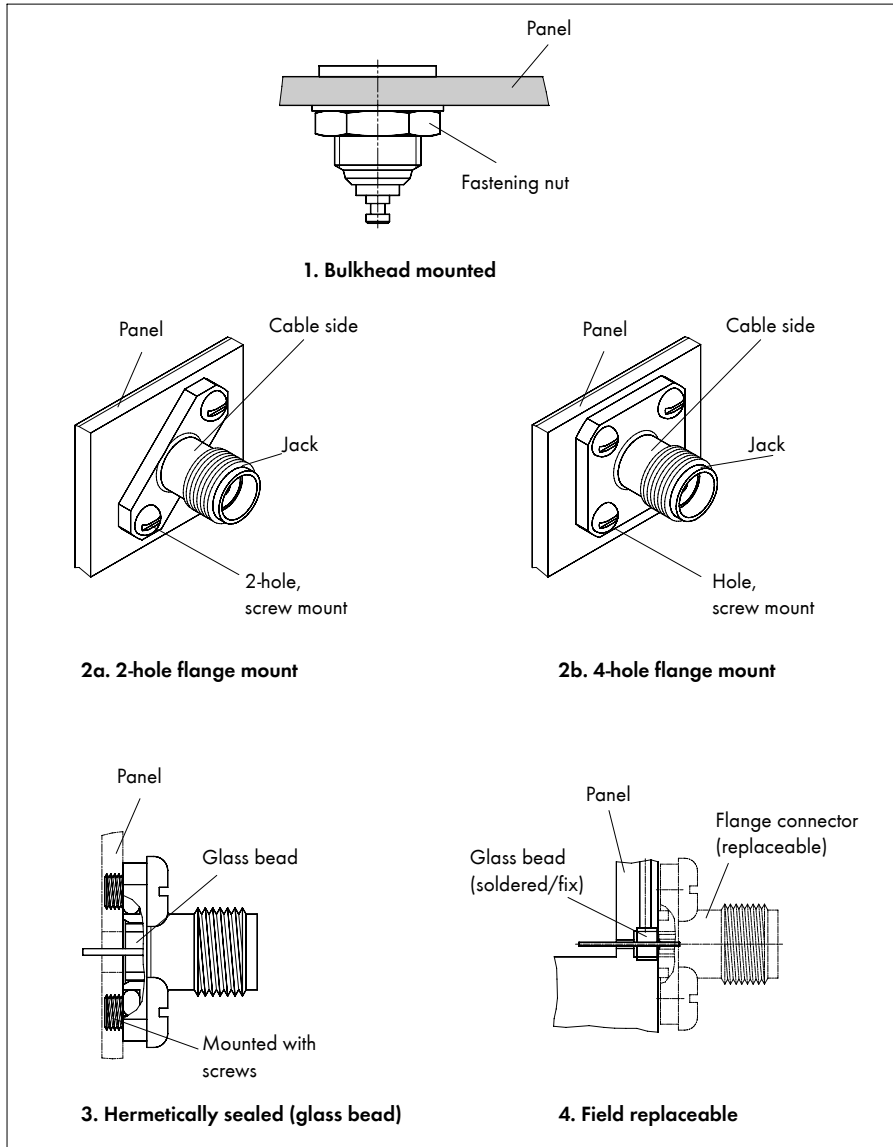

Figure 57 Panel-mounts

The bulkhead version (threaded Figure 57 (1)) is used for panel-mounting through a (metal) wall of, for example, an instrumentation box (also called feed-through). To prevent angular displacement, the through-hole is

D-shaped. Because the connector is threaded and provided with a fastening nut, it is possible to mount the connector faster than a 4-hole flange connector (2b).

However, this mounting method also requires that you can reach the connector on both sides of the panel. Usually, this technique is used when the attachment has to withstand some vibrations. The advantages of a bulkhead mount are that it is a fairly inexpensive mounting technique and that the connector is replaceable.

The two flange types shown above (2a and 2b) are applicable when the attachment can only be made on one side of the panel. The main hole in the panel for the inner conductor/housing is a normal through-hole, non-threaded, while the bores for the screws are threaded. The cost of this attachment is higher than the bulkhead type because of the extra bore operations. However, as with the bulkhead, this attachment also allows a replaceable connector.

The third possibility is the hermetically sealed attachment (3), which is in fact a variation of the flange type, also called non-field. In this case, the connector has an integral glass seal with an inner conductor (soldered). It is then mounted to the package housing with screws. Afterwards, the connector will be soldered to another device inside the box. This of course means that the solder process is carried out after mounting and that the connector cannot be re-installed once soldered. This technique is used when mounting takes place indoors, where soldering equipment is normally available and where the solder joint is easier to test for leakage. The applications requiring hermetic sealing mostly concern devices with high pressure or vacuum tightness requirements.

When mounting is carried out in the field, the field replaceable attachment (4) consisting of a connector and an external glass seal would be more advantageous, as the drop-in glass seal is soldered into the package housing in advance. The connector can be mounted to the panel and the inner conductor in the glass bead will attach to the connector centre contact with a jack-to-plug connection. This non-solder attachment is applicable when it is not recommendable to warp the surrounding devices. That is, the replacement of a damaged connector is also possible without affecting the hermetic circuit.

Another attachment type is the hermetic panel feedthrough using metal-to-metal seals (spark plugs), which is normally for hermetic connections (not shown here). The panel feedthrough consists of an internal hermetic glass seal and an external metal-to-metal seal to be placed between the connector and the package. This connector has no flange and is mounted by being torqued into place. The spark plugs are available in various types; rigid gasket (made of stainless steel) for thicker walls, compression gasket (usually of kovar) and the formable type (made of copper). Another seal possibility is the use of an O-ring. As with the field replaceable flange types, this connector type also allows several re-installations without damaging the package housing.

### 3.4.4 Attachment to the Print Board

When mounting a connector, it is important to be aware of the influence on the attachment from forces such as engagement, disengagement and mounting process forces such as pressing or soldering.

These three mounting methods are frequently used in PCB applications. The so-called press-in method (see Figure 58, left) means that the PCB connector with press-in legs (compliant pins) is inserted into the defined through-plated holes on the printed board. Compared to the more traditional PCB type with soldering attachment (Figure 58, centre), press-in mounting guarantees the same electrical and mechanical performance, but makes a more secure contact and is easier to assemble than with soldering.



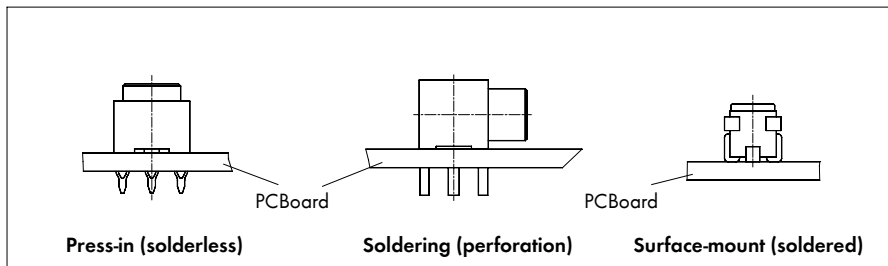

Figure 58 Attachments to a PCB or panel

The soldering method is used for three different types of connectors, the print socket with solder legs, the surface-mount and the edge-mount connector with solder leads. The print socket perforates the print board with legs similar to the press-in type, with the surface-mount or edge-mount being soldered on the surface of the print (see Figure 58, right), as is suggested by the name. The surface mount solder method generally does not ensure a higher contact quality because of lower resistance to vibrations, shock and forces, compared to press-fit and soldering (perforation).

### 3.4.5 Assembly Tools and Instructions

To guarantee good connector attachment and high production yields, various assembly tools and sets are available to control the assembly process. A tool is normally designed for the individual assembly method ensuring reliability and repeatability.

The advantage of such tools is that they can easily repeat the process (i.e. more than 5000 assemblies) if correctly calibrated. Calibration sets for these crimp tools are available from HUBER+SUHNER. The disadvantage is naturally the cost of the tools. However, the tooling costs can be ignored when compared to the costs of incorrectly assembled components and to the inherently better process-control (repeatability).

Two examples of tools from HUBER+SUHNER are the crimp tool and the cable stripping tool. The latter is used for stripping corrugated cables, sizes  $\frac{1}{2}$ " to  $1\frac{5}{8}$ " (Figure 59), which are assembled with the HUBER+SUHNER QUICK-FIT connectors N and DIN 7/16. The tools have been developed with the purpose of reducing assembly lead-time (from approx. 20 - 30 minutes to about 5 minutes) when compared to traditional tools.



Figure 59 Cable stripping tools

Assembly tools are an important factor in manufacturing, and must be treated as such, because an incorrectly calibrated tool is as bad as no tool whatsoever. To ensure a reliable assembly, the connector manufacturers' assembly instructions must be carefully followed. When in doubt about specific steps in the assembly process, please check with your HUBER+SUHNER representative.

**Some advice on how to achieve a good, reliable and repeatable attachment :**

- **Make sure the right attachment method has been chosen for the application by considering the exact requirements (electrical, mechanical and environmental).**
- **If a tool is needed for assembling, carefully consider the advantages and disadvantages of the available tools. Recommended tools are those with calibration sets and guaranteed repeatability.**
- **Follow the enclosed assembly instructions step by step. Check the results carefully. If in doubt, consult the manufacturer for help.**

## 3.5 COAXIAL CONNECTOR SERIES AND CABLES

### 3.5.1 Coaxial Connector Series

In the world of RF, there is a huge selection of standardised as well as individually defined coaxial connector series. Although hundreds of connector series have been invented, we will concentrate on 20 (50  $\Omega$ ) of the most commonly used types. They are divided up into design types according to size (refer to Table 18).

The classification of connector series may vary from manufacturer to manufacturer. The classification here is based on characteristics as identified by HUBER+SUHNER.

Design Type	Series
Microminiature	MCX, MMBX, MMCX, MMPX,
Subminiature	BMA, SMA, SMB, SMC, SMS, QLA, QMA, 1.0/2.3
Miniature	BNC, BNO, BNT, MHV, SHV, TNC
Medium	N, QN
Large	7/16
Precision	PC3.5, SK

Table 18 Coaxial connector series divided into design types

For each connector series, the characteristics as well as drawings, market segments, typical applications and finally some of the suitable cables are outlined, following the chapter on cables. This is an attempt to explain the similarities and differences between the series.

The selected series are designed to operate in the frequency ranges as follows:

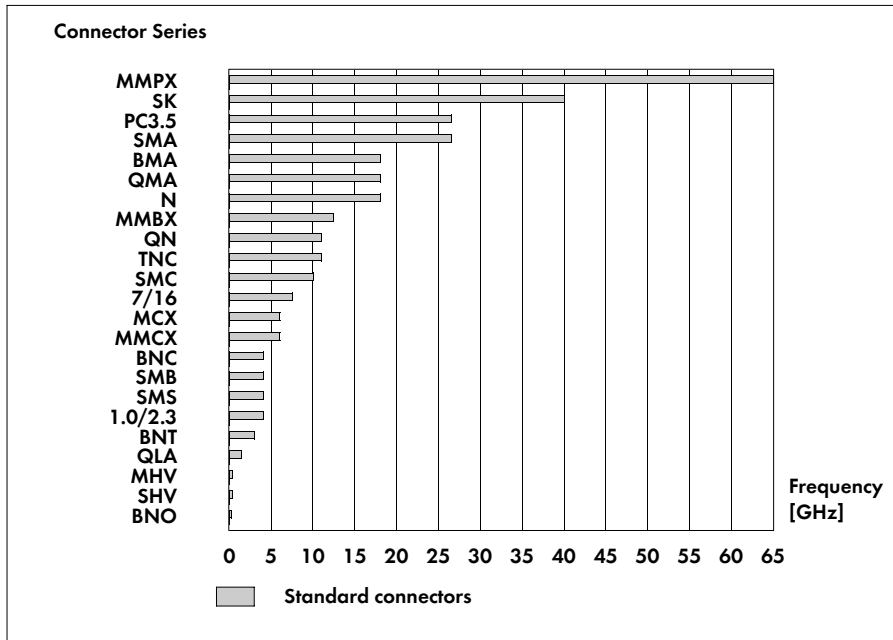

Table 19 Series by frequency ranges

In addition, several between-series and with-in series adaptors will finish this part of the chapter.

## 3.5.2 Coaxial Cables

This chapter will focus on cables and their specifications suited for the series mentioned above.

### 3.5.2.1 Cable Design

As an introduction to cable types, the cable and its various designs must be discussed. Normally, a coaxial cable consists of an inner conductor, dielectric and outer conductor for transmitting the electrical signal and a jacket to protect the inner transmitting parts against mechanical, chemical and environmental damage. The inner conductor may be a solid wire or, for improved flexibility, a stranded wire. A hollow tube is usually used for larger size cables instead of a solid wire to reduce the weight, the costs and to facilitate the bending of the coaxial cable. Please be aware that a stranded wire increases the insertion loss by approximately 5 to 10 %. Normally, the outer conductor will be braided (woven wires). Other designs are based on a combination of a wrapped tape with braided wires.

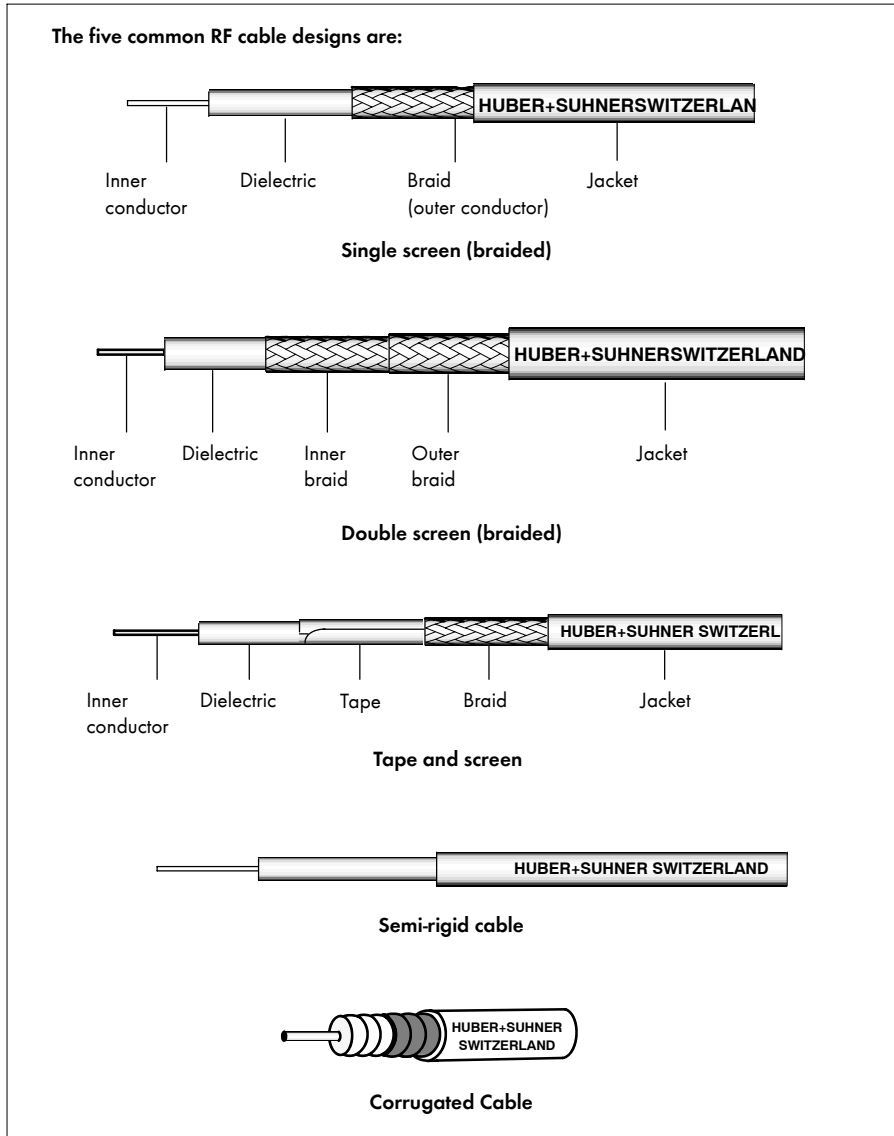

Figure 60 Cable designs

The designs above each used for different purposes, depending upon the operating frequency range and where the cable is installed. Table 20 below shows some of the features that are important for selecting the correct design.

<b>Design of outer conductor</b>	Single screen		Double screen		Tape and screen	
<b>Design of inner conductor</b>	Solid	Stranded	Solid	Stranded	Solid	Stranded
<b>Operating frequency range</b>	DC ... 1 GHz		DC ... 5 GHz		DC ... 18 GHz+	
<b>Screening</b>	-		Good		Excellent	
<b>Common coverages*</b>	90...95%		Screen A: 90...95% Screen B: 85...90%		Tape: 100% Screen: 85...90%	
<b>Flexibility**</b>	+	+++	+	++	+	++

<b>Design of outer conductor</b>	Tube (semi-rigid)	Corrugated		
<b>Design of inner conductor</b>	Solid	Solid	Tube	Screwed tube
<b>Operating frequency range</b>	DC ... 18 GHz+	DC ... 5 GHz		
<b>Screening</b>	Excellent	Excellent		
<b>Common coverages*</b>	100%	100%		
<b>Flexibility**</b>	n/a		+	+

Table 20 Cable design vs. features/purposes

\* Coverage is related to leakage - refer to Chapter 3.5.3.5 on page 91.

\*\* The flexibility is rated from barely flexible (+) to very flexible (+++)

The higher the coverage, the better the prevention of RF leakage by the cable. Note: Some cable types may differ from the above mentioned designs.

### 3.5.2.2 Cable materials

The materials used for cables may vary considerably from manufacturer to manufacturer, but to give a general impression of the options, some of the commonly used materials for each component are mentioned in the following:

**Inner and Outer Conductor Materials**

- Wires:**
- Unplated copper
  - Tinned copper
  - Silvered copper plated steel
  - Steel copper and silver plated
  - Copper plated aluminum
- Tapes:**
- Coated aluminum
  - Unplated copper
  - Silver plated copper
- Tubes:**
- Unplated copper
  - Tinned copper
  - Silver plated copper
  - Unplated aluminium (outer conductor for Semi-rigid cables)
  - Tinned aluminium (outer conductor for Semi-rigid cables)

**Dielectric Materials**

- Polyethylene PE (halogen-free)
  - Crosslinked PE PEX (halogen-free, temperature resistant)
  - Cellular polyethylene SPE (halogen-free, flexible)
  - Crosslinked SPE SPEX (halogen-free, flexible, temperature resistant)
  - Polytetrafluoroethylene PTFE (not flammable, less flexible, temperature-resistant [Teflon])
- Note: Teflon is a registered trade mark of DuPont

**Jacket Materials**

- Polyvinylchloride PVC (weather-resistant)
  - Polyethylene PE (halogen-free, weather-resistant)
  - Mod. copolyethylene LSOH (low smoke, zero halogen)
  - Copolyolefin Radox (halogen-free, temperature-resistant)
- Note: Radox is a registered trade mark of HUBER+SUHNER AG
- Polyurethane PUR (abrasion-resistant, flexible)
  - Fluoroethylene copolymer FEP (temperature and chemical-resistant)

The material specifications can be found in Appendix 5.2.

### 3.5.2.3 Halogen-free materials

As mentioned above, it would be necessary to use halogen-free materials for the jacket and/or for the dielectric.

Halogens include iodine, bromide, chlorine and fluorine. They all are water-soluble. In case of a fire, the danger of using cables with materials containing halogens can be severe. The released chlorine emissions will amalgamate with the surrounding water (the moisture in the air and the water used for extinguishing the fire) and create hydrochloric acid. The other substances are caustic too. In this situation, the steam will cause metal corrosion and will be toxic when inhaled by human beings.

### 3.5.2.4 Material selection guide

For a material selection guide and a detailed comparison of dielectric and jacket materials, please refer to the HUBER+SUHNER RF Cables General Catalogue.

## 3.5.3 Electrical Cable Performance

Coaxial cables are defined with various electrical parameters. Some of the most important parameters are listed below:

### 3.5.3.1 Impedance $Z_0$

Unit:  $\Omega$  (Ohm)

The most common impedance values are 50 and 75, but also 93/95 and others are sometimes used for special applications. The impedance depends on the diameter of the inner conductor and of the dielectric (mechanical dimensions) and on the dielectric material ( $\epsilon_r$ ). (Refer also to Chapter 1).

### 3.5.3.2 Capacitance C

Unit: F/m, pF/m (Farad per metre, Picofarad per metre)

Similar to the impedance  $Z_0$ , the capacitance is given by the mechanical dimensions of inner conductor and dielectric as well as electrical properties ( $\epsilon_r$ ) of the isolator.

### 3.5.3.3 Cut-Off Frequency $f_c$ and Operating Frequency Range

Unit: Hz, MHz, GHz (Hertz, Megahertz, Gigahertz)

The cut-off frequency depends on the diameter of the inner conductor, dielectric (mechanical dimensions) and on the dielectric material ( $\epsilon_r$ ). The frequency range will commonly be much lower than the cut-off frequency. Due to the much higher RF leakage on higher operating frequencies, the insertion loss will be influenced by increased radiation, especially in single braided cables.

### 3.5.3.4 Attenuation

Unit: dB/m, dB/100m (Decibel per metre, decibel per 100 metre)

The insertion loss is determined by the diameter of the cable (the bigger the cable dimensions, the lower the attenuation) and by the conductor and dielectric materials chosen. A conductor material with a low DC resistance



is better than one with a high DC resistance. This means that a silver plated copper wire results in a lower attenuation. Please be aware that the attenuation is expressed as a logarithmic ratio of input power to output power. The lower the  $\epsilon_r$ , the lower the attenuation. Ideally, the attenuation should be as low as possible.

### 3.5.3.5 Screening Effectiveness or Screening Attenuation $\alpha_s$

Unit: dB (Decibel)

The screening effectiveness depends on the type of braid and the length of the cable. Exceptions are the semi-rigid cable types, which offer the best possible screening effectiveness. Cable designs with foil/braid combinations also offer an excellent screening effectiveness. On cable designs with woven braids (single or double), the screening will also depend on various parameters of the braid (i.e. braiding angle, number of wires per spindle, etc.). Please note that a high coverage does not necessarily result in a high screening effectiveness. The longer the cable, the lower the screening. Ideally, the screening effectiveness should be as high as possible.

Note: Use threaded connectors when measuring screening effectiveness because other connectors can be significant error contributors.

### 3.5.3.6 Velocity of Signal Propagation $v_R$

Unit: % of c (percent of the speed of the light)

The velocity is only determined by the dielectric constant ( $\epsilon_r$ ).

## 3.5.4 Cable Types and their Characteristics

Out of a large number of different cables, we have chosen to deal briefly with four RF cable types. For detailed information please refer to the HUBER+SUHNER RF Cables General Catalogue and other HUBER+SUHNER cable brochures.

The four cable types in Table 21 are all available with various dimensions and designs. It is also possible to combine all their different designs and materials. In the following tables, the most important features of the types will be explained. A combination or cross-reference table between the connector series and the cable types is not given, as it is impossible to simply assemble a connector and a cable without knowing the exact application. A huge number of variations are possible for meeting the different requirements.

However, attention must be paid to the suitable cable group. The cable group defines a range of dielectric diameters and possible cable types, and is the link between the connector and the cable selection. The diameter of the cable inner conductor must more or less correspond to the diameter of the connector centre contact. This enables the number of possibilities to be considerably reduced. (The dielectric diameter in mm is mentioned in the HUBER+SUHNER connector and cable coding key).

Item	Flexible Cable (RG 58 C/U, RG 223 /U)	Feeder/Jumper Cable (SU-COFEED®)	μ-Wave Cable (SU-COFORM®, Semi-Rigid)	Flexible Micro-wave Cable (SU-COFLEX®)
Operating frequency range	DC ... 5 GHz	DC ... 5 GHz	DC ... 18 GHz	DC ... 50 GHz
Features	<ul style="list-style-type: none"> <li>- General purpose</li> <li>- With single screening applicable up to 1 GHz, with double screening up to 5 GHz</li> </ul>	<ul style="list-style-type: none"> <li>- Low loss cable</li> <li>- Available with large diameters and as corrugated cable</li> </ul>	<ul style="list-style-type: none"> <li>- High frequency cable</li> <li>- High C.W. and peak power</li> <li>- For fixed installations</li> <li>- Can be formed by hand (Alu-SR, SU-COFORM)</li> </ul>	<ul style="list-style-type: none"> <li>- Flexible micro-wave cable</li> <li>- Low loss</li> <li>- Phase stable</li> <li>- High screening</li> <li>- Excellent electrical performance</li> </ul>
Cable groups	U0 ... U45	M6 ... M42	Y1 ... Y12	Available as assembly only
Dielectric diameters	0.52mm..17.3mm (0.020" .. 0.681")	6.0mm .. 42.0mm (0.236" .. 1.654")	0.66mm .. 8.43mm (0.026" .. 0.332")	n/a

Table 21 Cable types, operating frequency range, features and cable groups/dielectric diameter

Note: All cable groups are in the HUBER+SUHNER connector and cable catalogues  
For further information please contact your application engineer at HUBER+SUHNER

### 3.5.5 Microminiature Connectors

In the Microminiature connectors group, the MMBX, MM CX and SMPX series are available.

#### 3.5.5.1 Characteristics

The MM CX is a HUBER+SUHNER specified miniature version of the MCX connector (approx. 30% smaller). This connector series (50 ohm) has a Snap-on coupling mechanism, which is achieved by a snap ring. This mechanism guarantees rapid engagement and disengagement and a good reproducibility of electrical performance. In addition, the connectors have a low RF leakage due to a non-slotted outer conductor. The frequency range is DC - 6 GHz.

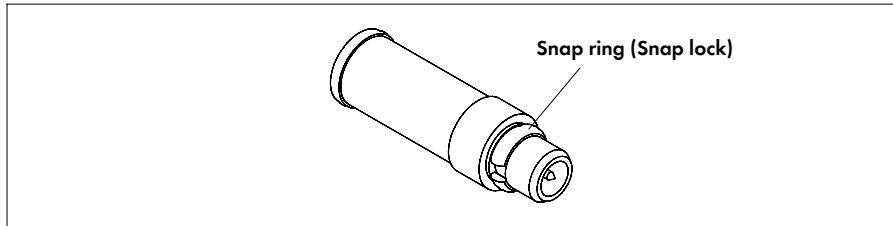

Figure 61 MMCX plug connector

The MMCX connectors are available as traditional cable connectors as well as PCB sockets and surface-mounted/edge-mounted types.

### 3.5.5.2 Segments and Typical Applications

MMCX connectors are suitable for applications such as PCBs, where the outer dimensions have to be as small as possible and where easy and reliable coupling is important. These applications could be Telecoms (is developed especially for mobile telephone applications) or perhaps for test and measurement (T&M) purposes, such as mobile handsets.

Series	Segments	Typical Applications
MMCX	Telecoms (wireless)	In mobile telecommunication equipment e.g. portable equipment
	Test and Measurements	T&M equipment

Table 22 Microminiature segments and applications

### 3.5.5.3 Typical Cables

MMCX cable connectors can be attached to semi-rigid cables and with full crimp to flexible cables.

The specified cable groups (refer to connector catalogue), Y3, Y11 and U0, U1 respectively, with dielectric diameters from 0.51 to 1.50 mm (0.02 to 0.059 inches) are suitable for this series.

## 3.5.6 Subminiature Connectors

### 3.5.6.1 Characteristics

The MCX series is a subgroup of the Subminiature connectors, because its outer diameter is about 30% smaller and it is lighter than the SMB connectors, even though it has the same inner conductor and dielectric dimensions. However, the MCX is placed in this group because it is defined as a substitute for the SMB and is larger than the MMCX. The frequency range for 50 ohm designs is DC to 6 GHz. The MCX connector is also available with a 75 ohm impedance, which can substitute the connectors DIN 1.6/5.6 and SMB 75 ohm. The MCX 75 ohm is mateable with the MCX 50 ohm.

As with the MMCX it has a Snap-On coupling mechanism, which ensures high reliability and repeatability. Another feature is the reduction of space compared to the SMB connector.

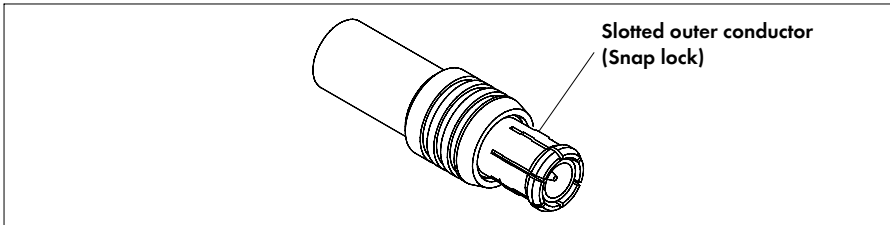

Figure 62 MCX plug connector (male)

Originally, the SMA series was specified for semi-rigid cable 0.141" and as precision connectors for microwave applications in the military industry. The SMA has high mechanical strength, mainly because of the threaded coupling mechanism, and a frequency range from DC to 18 GHz with semi-rigid cables (DC to 12.4 GHz when attached to a flexible cable and in some cases special designs operating mode free up to 26.5 GHz are available). HUBER+SUHNER SMA connectors are available with 3 different materials: standard beryllium-copper with gold-plating, stainless steel and the economic version in brass with SUCOPLATE plating.

SMA connectors have various designs: cable connectors, receptacles, stripline, microstripline, hermetically sealed, PCB, shorts and various adaptors.

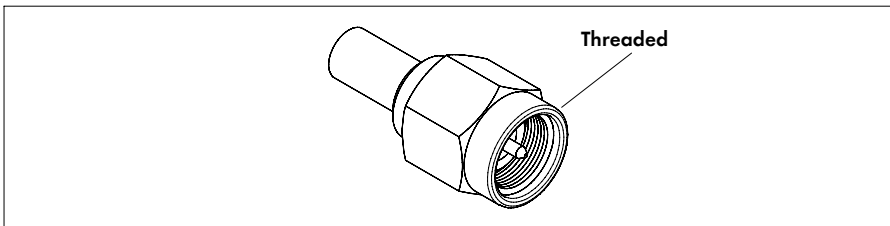

Figure 63 SMA plug connector

The QMA interface has a very similar performance to the SMA, but in addition it offers an easier, faster and safer coupling operation, helping the customers to save significantly time during production of their systems. The packaging density of QMA is increased compared to SMA thanks to the fact that no torque spanner is required to fasten the coupling nut. QMA is designed for applications up to 6 GHz as required by today's and tomorrow's radio base stations.

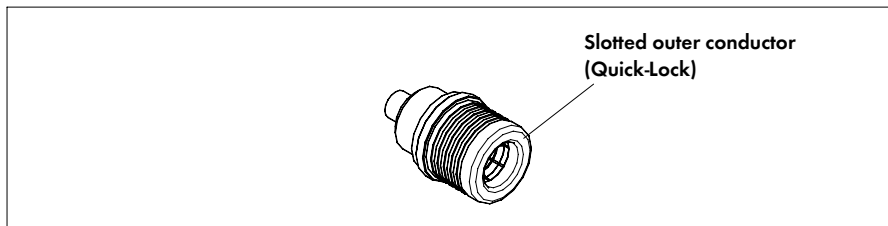

Figure 64 QMA plug connector

The SMB series (50 ohm) consists of connectors designed in a similar way to the SMA connector, but is provided with a Snap-On coupling mechanism and has a frequency range from DC to 4 GHz. Its main feature is rapid engagement and disengagement, as with other connectors that use Snap-On techniques. Generally, they have a good performance, even in moderate vibration environments.

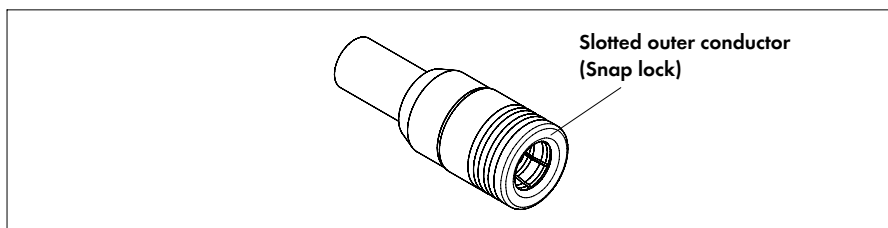

Figure 65 SMB plug connector

The SMC series (50 ohm) has a design identical to the SMB (inner conductor and insulator) except for the coupling mechanism, which uses a threaded connection. Because of this, it is a vibration proof connection and can be used up to 10 GHz as a substitute for the SMB connector.

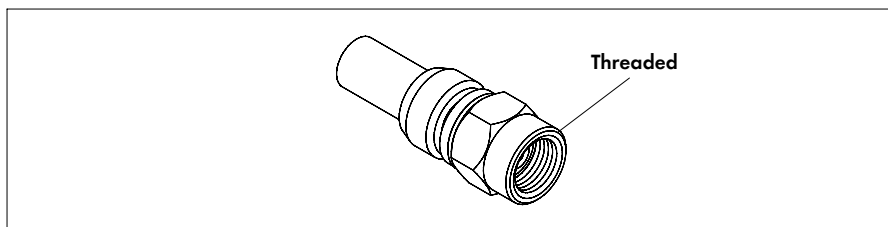

Figure 66 SMC plug connector

The 1.0/2.3 series (inserts) is designed in accordance with the German standard DIN 41626/2 (Type D connector) and is suitable for insertion in mixed layout connectors (DIN 41612 pattern M). The inserts are provided with a Slide-On coupling mechanism, which ensures fast connection and high reproducibility. The frequency range is DC to 4 GHz, but is applicable at higher frequencies too (at higher VSWR). To remove the 1.0/2.3 from the DIN 41612, it is necessary to use a removal tool.

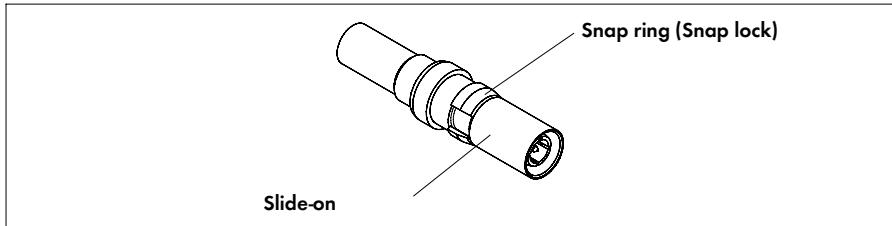

Figure 67 1.0/2.3 insert, plug

The BMA series (50 ohm) consists of blind mate connectors with fixed as well as floating contacts. These types can accommodate a certain amount of axial and radial misalignment. The connector centerline to centerline is reduced, resulting in higher packing density and lower overall space and weight. They can be attached to flexible and semi-rigid cables. Frequency range is DC to 18 GHz.

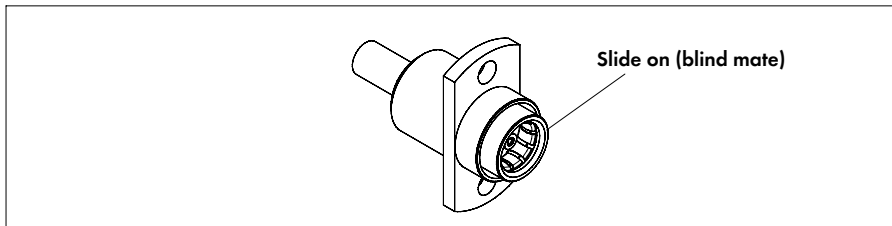

Figure 68 BMA plug connector

### 3.5.6.2 Segments and Typical Applications

The main purpose of using the MCX connector is its reduced space requirements and ease of connecting, which is essential in almost every application, such as mobile base stations and T&M.

SMA connectors are used in many different applications, but mostly in T&M and military/defence products, because they have a high durability and low VSWR (refer to Table 23, page 97).

SMB connectors are used where a quick connection is required, e.g. internally in a mobile control station, and for applications with limited space.

SMC connectors are also installed in mobile equipment as with the SMB, where a stable and permanent connection is needed.

1.0/2.3 inserts are used for various rack and panel purposes in mobile equipment (refer to Table 23). The inserts have full crimp attachment to flexible cables and crimp-solder attachment to semi-rigid cables.

BMA connectors are suitable for applications where a multiple connector contact is required. This could be a selection of BMA connectors affixed to a panel board and coupled to a subsystem. They are characterized by their ease of assembly and reliability.

Series	Segments	Typical Applications
MCX, SMA	Test and Measurements	For T&M equipment
MCX, QMA	Telecoms	- Miniature GPS receivers - Internal wiring in base stations
SMB, SMC, 1.0/2.3	Telecoms (fixed)	In mobile telecommunication equipment e.g. control station (rack and panel 1.0/2.3)
MCX, SMC, QMA	Telecoms (wireless)	For mobile base stations and general purpose
SMC BMA	Avionics	Sub-systems; System "blind-mating" interconnections e.g. rack and panel systems
SMA	Military/Defence	Airborne radar

Table 23 Subminiature - segments and applications

### 3.5.6.3 Typical Cables

It is possible to attach the Subminiature connectors to many different cables. Therefore, the typical cable groups will be mentioned for each series individually.

Series	Cable Groups	Dielectric diameter
MCX	U1, U2, U4, Y2, Y3, Y11	0.51-1.50 mm (.020 .0591 inches)
SMA, QMA	U2, U4, U7, U9, U10, U11, Y2, Y3, Y5, S16	1.51-3.75 mm (.0594 .1476 inches)
SMB	U1, U2, U4, U5, Y3, Y11	0.51-1.50 mm (.020 .0591 inches)
SMC	U1, U2, U4, U5, Y3, Y11	0.51-1.50 mm (.020 .0591 inches)
1.0/2.3	U2, U4	1.51-1.50 mm (.0594 .0591 inches)
BMA	U2, U9, U10, U11, Y3, Y5	1.51-2.95 mm (.0594 .1161 inches)

Table 24 Cable groups for subminiature connectors

### 3.5.7 Miniature Connectors

The Miniature connector series ranges from some of the most commonly used connectors in electronics, such as BNC and TNC, to some of the more special connectors such as BNO (twinaxial) and BNT (triaxial). MHV and SHV connectors have a lower frequency range, but a much higher voltage range.

#### 3.5.7.1 Characteristics

The BNC series (Bayonet Navy Connector) consists of connectors featuring a two-stud bayonet coupling mechanism, which ensure quick and frequent mating. The connectors are available with 50 ohm for frequency range DC to 4 GHz and 75 ohm for DC to 1 GHz. The 75 ohm versions are standard 50 ohm connectors with a reduced dielectric at the interface. The 50 ohm and 75 ohm versions are intermateable.

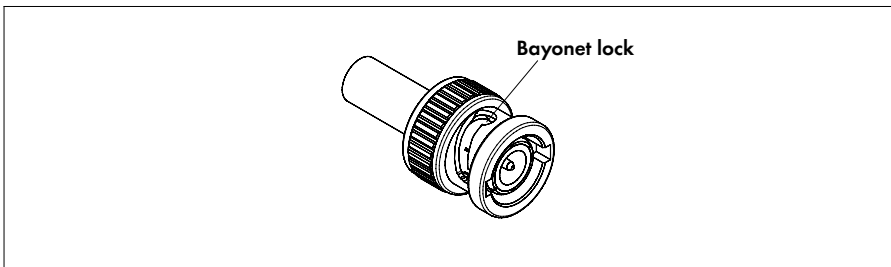

Figure 69 BNC plug connector

The TNC series has the same design as the BNC, except for the coupling mechanism, which uses a threaded coupling. The tighter fit provided by this screw-on connection improves the interface control. Due to this coupling, they can also withstand shock and vibration. The frequency range for TNC 50 ohm is DC to 11 GHz. However, the precision designs with dielectric support bead are able to work up to 18 GHz.

The 75 ohm designs for impedance matching are suitable for precision video and computer cables.

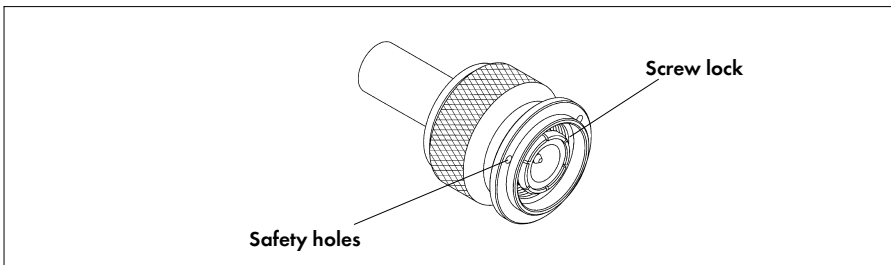

Figure 70 TNC plug connector



MHV means **Miniature High Voltage**. These connectors have a working voltage up to 1.6 kV. They appear almost similar to the BNC, but MHV connectors have elongated insulators overlapping the inner conductor. This gives good shock protection when unmated.

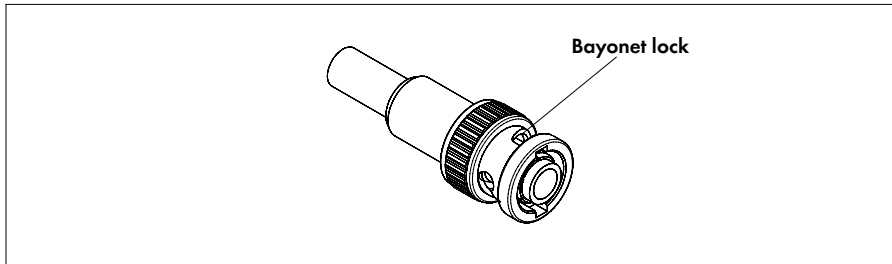

Figure 71 MHV plug connector

SHV (50 ohm) connectors are **Safe High Voltage** connectors (up to 3.5 kV). When the connector is unconnected, an excellent protection against electrical shock due to handling is guaranteed, because the pin as well as the socket are recessed within the housing. The design of the SHV also has a bayonet coupling mechanism.

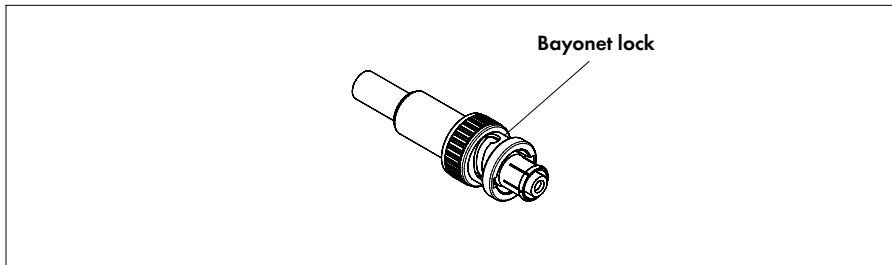

Figure 72 SHV plug connector

The BNO series is twinaxial, with a two-pin bayonet coupling mechanism, 1 female and 1 male, which is called polarization. This type of connector requires attachment to twin-conductor cable, which is not covered in this book.

Although the BNO is similar to the BNC connector, it is not possible to mate the two types. More recently some four-pin designs have appeared on the market. The BNO has no defined impedance, but works up to 200 MHz.

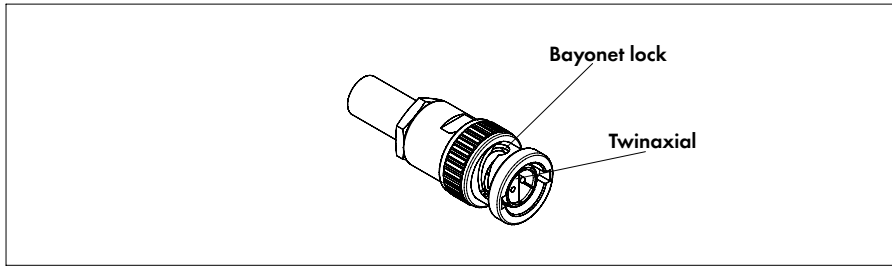

Figure 73 BNO plug connector

The BNT is a triaxial connector with three concentric contacts and a bayonet coupling similar to the BNC, which is mateable with the BNT. The only suitable cable is triaxial cable, which is not outlined here. The impedance between the inner conductor and the inner of two outer conductors is 50 ohm. The frequency range is DC to 3 GHz.

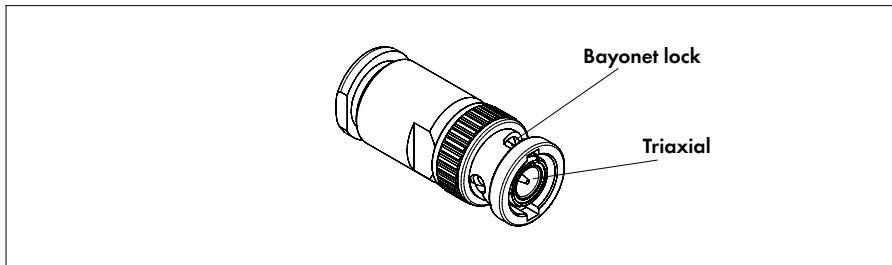

Figure 74 BNT plug connector

### 3.5.7.2 Segments and Typical Application

The BNC is used for a very large number of purposes, such as industrial products, military and T&M.

Normally, the TNC is used for similar applications as the BNC, but where a higher frequency range and higher vibration resistance are required. The threaded coupling makes them particular suitable for e.g. mobile radar applications.

The MHV and SHV connectors are both useable in high voltage products, where electrical shock must be avoided when handled unmated.

The twinaxial BNO is commonly used in the data communication industry.

The BNT connectors are mostly used for T&M purposes.

Series	Segments	Typical Applications
BNC, TNC	Military, space + general use	Military radio and mobile radar systems
	Test and Measurements	For T&M equipment
MHV, SHV	Nuclear Medical equipment	Nuclear equipment (T&M) High voltage applications
BNO	Datacoms	For computer networks (LAN)
BNT	Test and Measurement	- Sensor probes - Critical signal measurement

Table 25 Miniature - segments and applications

### 3.5.7.3 Typical Cables

Each connector series has defined suitable cable groups outlined below.

Series	Cable Groups	Dielectric diameter
BNC	U1, U2, U3, U4, U5, U7, U9, U10, U11, U15, U16, U17, U18, U28, U29, U30, U31, U32, U33	0.51-7.25 mm (.020 .2854 inches)
TNC	U1, U2, U4, U7, U9, U10, U11, U15, U16, U17, U18, U28, U29, U30, U31, U32, U33	0.51-7.25 mm (.020 .2854 inches)
MHV	U7, U15, U16	2.51-3.70 mm (.0988 .1457 inches)
SHV	U7, U9, U15, U16	2.51-3.70 mm (.0988 .1457 inches)
BNO	V1 *	3.51-4.00 mm (.1382 .1575 inches)
BNT	W1, W2, W3 *	1.51-4.00 mm (.0594 .1575 inches)

Table 26 Cable groups for miniature connectors

\* The cable groups V and W are symmetrically screened and triaxial cables, respectively.

## 3.5.8 Medium Connectors

The Medium connector series is a range of medium sized connectors, which could neither be defined as traditional Subminiature connector nor as large connectors.

### 3.5.8.1 Characteristics

N connectors (50 and 75 ohm) are characterised by their threaded coupling mechanism, which ensures excellent and reliable mating. N means navy connector. It is applicable for medium performance and can be attached to flexible and semi-rigid cables. The N connector is specified to 11 GHz, but is also available as a precision

connector provided with a dielectric support bead with a frequency range up to 18 GHz. The 75 ohm design is not standardized and not intermateable with the 50 ohm type.

In addition, some of the N connectors belong to the HUBER+SUHNER range of QUICK-FIT connectors. QUICK-FIT means quick assembling of corrugated cables, e.g. SUCOFEED, to these connectors, which consist of a minimum of components.

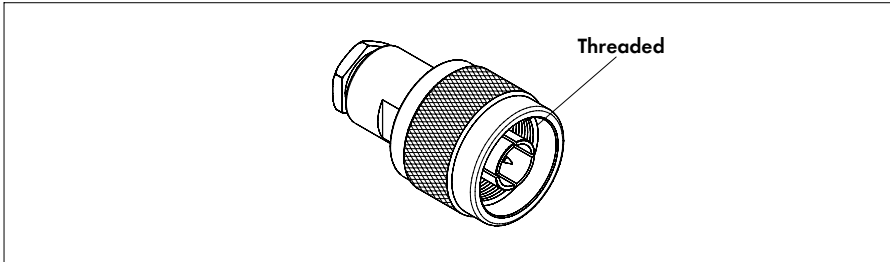

Figure 75 N plug connector

### 3.5.8.2 Segments and Typical Applications

N connectors are suitable for applications where a rugged design is needed and good signal transmission is required between two external subsystems, such as a connection from a control station to a mobile cellular base station. Furthermore, they are widely used in T&M applications.

Series	Segments	Typical Applications
N, QN	Telecoms (wireless)	Mobile base station usage
	Test and Measurements	For T&M equipment
	Military/Defence (Avionics)	Radar systems

Table 27 Medium - segments and applications

### 3.5.8.3 Typical Cables

Medium sized connectors require large and rugged cables, which can transmit the signals virtually without loss. The suitable cables are: semi-rigid, flexible, superflexible and corrugated cables.

Series	Cable Groups	Dielectric diameter
N	U2, U4, U7, U9, U10, U28, U29, U30, U32, U33; Y3, Y5, Y7, Y8, Y9, Y11, Y12, M6, M8, M12, M23	2.51 - 23.50 mm (.0988 - .9252 inches)
QN	U7, U9, U11, U29, U32, U33, S16, Y5, Y12	1.50 - 9.50 mm (.0590 - .3740 inches)

Table 28 Cable groups for medium connectors

### 3.5.9 Large Connectors

The large connector group concerns connectors with a very rugged design and high mechanical reliability.

#### 3.5.9.1 Characteristics

The 7/16 DIN series (50 ohm) consists of physically large and robust connectors with an inner conductor diameter of 7 mm (.2756 inches) and an internal outer conductor/body diameter of 16 mm (.6299 inches), these dimensions having given this connector its name. The connector has a low transmission loss with good intermodulation performance, suited for signal transmission from medium to high power. The coupling mechanism is threaded. The 7/16 connector works up to 7.5 GHz and is available in a HUBER+SUHNER QUICK-FIT version (refer to Chapter 3.5.8.1 on page 101, N connectors).

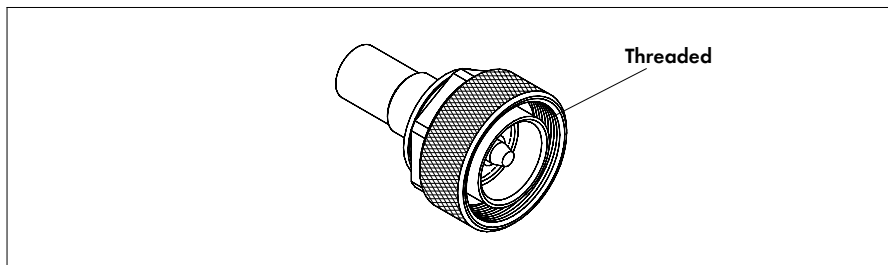

Figure 76 7/16 plug connector

#### 3.5.9.2 Segments and Typical Applications

Series 7/16 is used in low-loss transmission outdoor applications. Therefore, these products have to be partly water-proof and non-corrosive. Typical applications are: mobile cellular base station links, lightning protection and antenna feed systems.

Series	Segments	Typical Applications
7/16	Telecoms (wireless)	Mobile base station usage
	Military/Defence	Antenna feed systems, EMPs

Table 29 Large connectors, market segments and typical applications

#### 3.5.9.3 Typical Cables

The above series are normally attached to physically large coaxial cables (eg antenna feed cables), as well as corrugated cables, which traditionally can be difficult to assemble. With the aid of special HUBER+SUHNER QUICK-FIT tools, the time required for assembling is reduced considerably.

Series	Cable Groups	Dielectric diameter
7/16	U28, U29, U32, U33; U38, U44, M8, M9, M12, M23, M32, M42	6.51-42.50 mm (.2563-1.673 inches)

Table 30 Cable groups for large connectors

### 3.5.10 Precision Connectors

Precision connectors are characterized by their improved electrical repeatability and high operating frequency.

#### 3.5.10.1 Characteristics

The PC3.5 series has an air dielectric interface and a thicker wall thickness than the SMA connectors due to the 3.5 mm (.138 in.) airline and has also a threaded coupling mechanism. This enables the connector to be applied up to 26.5 GHz and with adaptors to 33 GHz. The PC3.5 is intermateable with SMA and K.

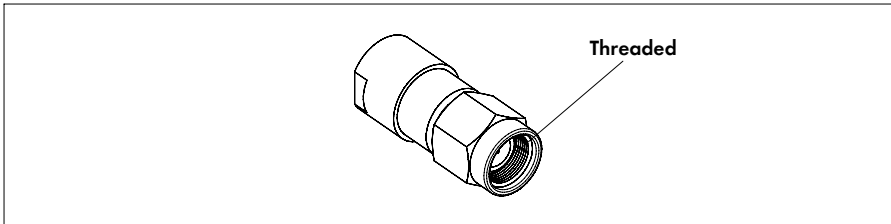

Figure 77 PC3.5 plug connector

SK connectors also have an air dielectric interface and a higher frequency range than PC3.5 connectors, from DC to 40 GHz (cut-off frequency up to 46.5 GHz), to which only few suitable cables can be attached.

They are intermateable with both PC3.5 and SMA. The mechanical stability is high, and the repeatability is very good.

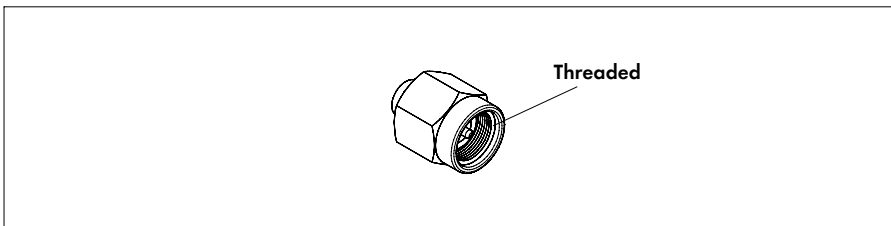

Figure 78 SK plug connector

### 3.5.10.2 Segments and Applications

Normally, the connector series PC3.5 and SK are both used for test and measurement purposes. The cable groups suited to PC3.5 connectors are typically semi-rigid cables, such as Y3, Y5, Y11 and Y12. Typically, the SK connector is attached to specially adjusted semi-rigid cable specified as cable size Y10 (refer to connector catalogue).

Series	Segments	Applications
PC3.5, SK	Test and Measurement	Testing equipment applications

Table 31 Precision - segments and applications

### 3.5.11 Within-Series and Between-Series Adaptors

Within-series or between-series adaptors are normally used to make a transition from one transmission line to a similar or different type. These adaptors can also be used to extend an existing transmission line, for example between an internal and an external system.

#### 3.5.11.1 Characteristics

Adaptors are characterized by having either a female to female or a male to male connection. In addition, they are available as standard or precision and as chassis mounting designs to enable panel feed-through connections (refer to connector catalogue for drawings and specifications and Appendix A). In addition, they have a high repeatability and good durability.

The adaptors have a high performance, which is normally standardized (e.g. between-series in MIL Standard 55 339). The high performance is usually achieved by the threaded coupling mechanism and perhaps an air dielectric interface. Threaded coupling means slower mating, however, HUBER+SUHNER has launched so-called "QUICK-TEST" adaptors with a quick-connect feature, which facilitates the measurement connection considerably.

#### 3.5.11.2 Segments and Applications

As written above, the adaptors are used in applications where the transmission line has to be extended or connected with an internal or external component. Furthermore, they are commonly used for test and measurements purposes.

	Segments	Applications
Adaptors	Test and Measurement General use	Testing equipment applications Extension of existing connections/lengths

Table 32 Adaptors

## 3.6 STANDARDS

It would be too complex and beyond the purpose of this book to describe all the standards which RF connectors must satisfy to. In the following, only the various standardization committees are listed. For further information, please refer to the specific addresses mentioned below or contact your national standardization boards.

Standardization Committee	Origin and Description
MIL	US, International standard Based on military requirements
IEC	International Makes recommendations only Standards for interface dimensions and test methods
CECC	Europe European quality assurance system Independent supervision Issues QPL Intended to replace national systems
Other National Standards:	
EIA	USA
DIN	Germany
BS	Great Britain
NF	France

Table 33 Standardization Committees





## 4. TESTS AND MEASUREMENTS

CONTENTS	PAGE
<b>4.1 MEASUREMENT THEORY AND METHODS</b> .....	<b>111</b>
4.1.1 Two-Port Network .....	111
4.1.2 Four-Terminal Networks at High Frequencies .....	112
4.1.2.1 Forward and Reverse Transmission Coefficient .....	113
4.1.2.2 Input and Output Reflection Coefficient .....	114
4.1.2.3 Matched Ports and Absolute Quantities .....	114
4.1.2.4 One-Port Network .....	115
<b>4.2 PRACTICAL MEASUREMENTS</b> .....	<b>115</b>
4.2.1 Calibration of Basic Test Set-up .....	117
4.2.2 Measurements of Reflections and Transmission .....	118
4.2.3 Example No. 1: Return Loss and Insertion Loss of an MA-Assembly .....	119
4.2.4 Example No. 2: Return Loss of an N-Assembly .....	124
4.2.5 Measurement of Passive Intermodulation Level (PIM) .....	128
4.2.6 Example No. 3: Passive Intermodulation .....	129
<b>4.3 DOS AND DON'TS</b> .....	<b>135</b>

## 4 TESTS AND MEASUREMENTS

To achieve an optimum design, to make specifications and to verify the electrical performance of RF cable connectors, various tests and measurements are necessary both during the design period, after product release and before the integration in a system. An important issue to keep in mind are the requirements for making reliable measurements. The proper devices for the measurement have to be available, and the correct procedures must be carefully followed.

Outlining how to measure RF cable connectors, this chapter focuses on descriptions of some of the most frequently used specifications; e.g. reflection coefficient or return loss, forward transmission loss or insertion loss, and passive intermodulation products. The main emphasis is placed on the measurement and parameter theory, practical examples and test set-ups of the described methods. Finally, a list of recommendations for measurements and of the dos and don'ts end this chapter.

### 4.1 MEASUREMENT THEORY AND METHODS

When connectors are to be tested, it is essential to know that only connector pairs can be measured. This means that when measuring cable connectors (part of a cable assembly), they will always be mated with an adapter or a termination to complete the transmission line. Otherwise, it is not possible to carry out the measurement.

The selection of a method normally depends on the item to be tested. The following deals with both the one and two-port network methods. Theory, specifications and influences on passive intermodulation products are also described in Chapter 1.6 (see page 36). First, the introductory description of the methods is given in the most elementary form possible. Second, the methods and their equations are related to the practical use of a modern vector network analyser, combining necessary equipment; i.e. reflectometers, voltmeters, etc. In addition, the typical test set-up and some of the most frequently measured parameters are described.

#### 4.1.1 Two-Port Network

A two-port network is a system provided with two accesses (ports). Through these ports, the system can exchange electrical, optical, mechanical, acoustical or other energies with the surroundings. Examples: A loudspeaker has a system containing one electrical and one acoustical port. An electric engine has a mechanical and an electrical port.

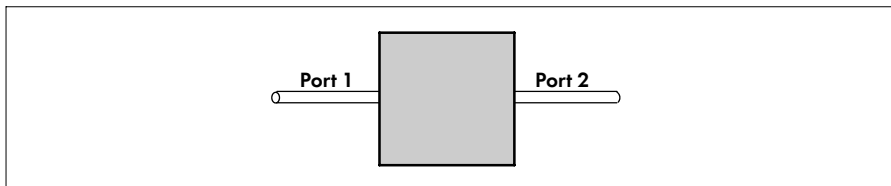

Figure 79 Simplified two-port network

The electrical two-port network is identical to a four-parameter network, because every port consists of a sum of waves, which can be separated into a forward and a reflected wave through a so-called directional coupler. We will confine ourselves to the description of pure electrical one-port and two-port networks, i.e. systems with one or two electrical access pairs.

### 4.1.2 S-Parameters

The quantities, voltage and current, lose their uniqueness and will be increasingly difficult to measure at high frequencies (MHz range and higher). In the microwave range, it is easier to handle the incoming and outgoing waves in a two-port network and thereby characterise the system.

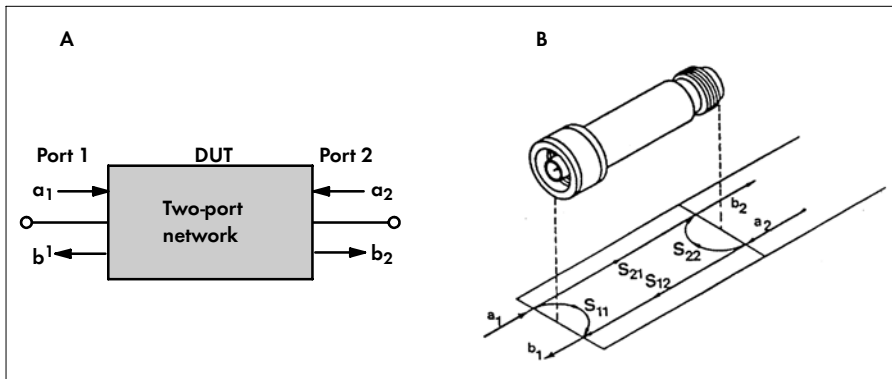

Figure 80 Simplified views of the incoming and outgoing waves in a two-port network

Note: DUT is the abbreviation of Device Under Test.

Figure 80 (A and B) shows the electrical incoming waves, called  $a_1$  and  $a_2$ , and the outgoing waves with the aid of arrows,  $b_1$  and  $b_2$ . However, it is a prerequisite that both ports are perfectly closed outwards, and that the outgoing signals are not reflected back to the two-port.

The two-port network can be characterised systematically by means of so-called S-parameters (scattering parameters). For a full description and calculation, 4 parameters – corresponding to the matrix  $2 \times 2$  – are needed. By using these parameters related to the incoming and outgoing waves, the following equations will apply:

$$\begin{aligned} b_1 &= s_{11} \cdot a_1 + s_{12} \cdot a_2 \\ b_2 &= s_{21} \cdot a_1 + s_{22} \cdot a_2 \end{aligned} \quad \text{or} \quad (40)$$

$$\begin{bmatrix} b_1 \\ b_2 \end{bmatrix} = \begin{bmatrix} s_{11} & s_{12} \\ s_{21} & s_{22} \end{bmatrix} \begin{bmatrix} a_1 \\ a_2 \end{bmatrix} \quad (41)$$

The outgoing waves make up an S-matrix as a function of the incoming waves. The meaning of the parameters is:

- $s_{11}$ : Input-reflection coefficient (return of signal  $a_1$  to input at port 1)
- $s_{22}$ : Output-reflection coefficient (return of signal  $a_2$  to output at port 2)
- $s_{21}$ : Forward-transmission coefficient (transmission through to port 2)
- $s_{12}$ : Reverse-transmission coefficient (transmission through to port 1)

The S-parameters are frequency dependent

Due to the extended use of modern vector network analysers, the S-parameters have become more important and easier to determine. Today, they are the most frequently used network parameters in the passive transmission technique. However, more details are necessary to describe the function and calculations of coefficients, which are all expressed by S-parameters (refer to Figure 80).

What is important to remember is that S-parameters are complex factors and dependent on the frequency. They have a value designated in dB and a related phase, which are measured in terms of incident and reflected voltages using a vector voltmeter or a vector network analyser (called VNA).

#### 4.1.2.1 Forward and Reverse Transmission Coefficient

The transmission parameter  $s_{21}$  is the ratio of the outgoing wave ( $b_2$ ) at port 2 to the incoming wave (called  $a_1$  or reference level) at port 1. The reversed parameter  $s_{12}$  is the ratio of the outgoing wave ( $b_1$ ) at port 1 to the incoming wave ( $a_2$ ) at port 2.

As mentioned above, the S-parameters are complex quantities. The value as well as the phase contain important information about the function of the two-port network.

To be able to better interpret the system, the two ports can be regarded as the input end (port 1) and the output end (port 2).

The electrical matching of various transmission lines under stable environmental conditions is called phase matching or power-factor correction. These factors are marked with  $^{\circ}\text{el}$  (electrical phase) and determined at a specific frequency and wavelength, respectively. The phase difference, or the alignment of two transmission lines or more, is defined as phase tracking or phase alignment.

Theoretically, many passive transmission lines are symmetrical or balanced, thus that  $s_{21}$  and  $s_{12}$  – in spite of some inaccuracies – are identical values.

#### 4.1.2.2 Input and Output Reflection Coefficient

The reflection parameter  $s_{11}$  is the ratio of the reflected wave ( $b_1$ ) to the incoming wave ( $a_1$ ) at port 1 when port 2 is terminated. For  $s_{22}$  the ratio is formed by the incoming wave  $a_2$  at port 2 and the reflected wave  $b_2$ , respectively. The wave  $a_1$  is always defined as the reference level (measured).

The two above-mentioned parameters are also complex quantities. The value of the reflection coefficient is of great importance. The reflection phase in cable-connected transmission lines, however, is mostly irrelevant. As the unit measure for the value of the reflection coefficient  $s_{11}$ , the relative unit (dB) is applied.

#### 4.1.2.3 Matched Ports and Absolute Quantities

In the description below, the two-port network and its parameters are related to the influence of matched ports, i.e. when either port is omitted. It means that one port is matched. The matching by the VNA is organised by an internal switch, which is automatically changed from sending signals through port 1 and leaving port 2 out, or vice versa.

The purpose of matching is to find the quantities of the desired coefficients, which are the reflection waves deriving from and forward waves leaving the device under test (hereafter called DUT). The DUT will normally consist of two connectors and a cable to connect them (a cable assembly)

##### Situation 1:

When the generator is connected to port 1, and port 2 is perfectly matched ( $a_2 = 0$ ), the equations of the S-parameters {refer to equation (40), page 110} are reduced to the following:

- |           |                                                                                                                        |                    |      |
|-----------|------------------------------------------------------------------------------------------------------------------------|--------------------|------|
| <b>A.</b> | <b>Input-reflection coefficient:<br/>Viewed from port 1 (still <math>a_2 = 0</math>).</b>                              | $s_{11} = b_1/a_1$ | (42) |
| <b>B.</b> | <b>Forward-transmission coefficient:<br/>Voltage transmission coefficient from port 1 to port 2 when 2 is matched.</b> | $s_{21} = b_2/a_1$ | (43) |

##### Situation 2:

When the source is connected to port 2, and port 1 is perfectly matched ( $a_1 = 0$ ):

- |           |                                                                                                                             |                    |      |
|-----------|-----------------------------------------------------------------------------------------------------------------------------|--------------------|------|
| <b>A.</b> | <b>Reverse-transmission coefficient<br/>Voltage transmission coefficient from port 2 to port 1, when port 1 is matched.</b> | $s_{12} = b_1/a_2$ | (44) |
| <b>B.</b> | <b>Output-reflection coefficient<br/>Looking into port 2 when port 1 is matched.</b>                                        | $s_{22} = b_2/a_2$ | (45) |

#### 4.1.2.4 One-Port Network

The one-port network is actually a part of the two-port network. It is a two-port network without one of the ports, which is normally port 2 (see Figure 81). By this, a termination, e.g.  $50 \Omega$ , works as a one-port network. When it is connected to port 2 at the DUT, the two parts become a one-port network. Port 2 at the VNA will not be used. This method is often used when only the reflection coefficient is desired.

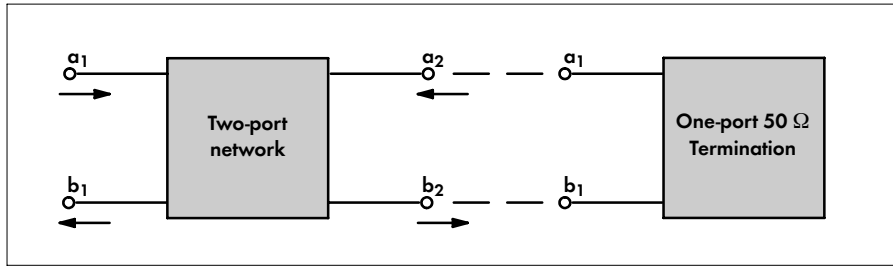

Figure 81 Schematic diagram of one-port network set-up with DUT and 50  $\Omega$  termination

Omitting port 2, the number of basic equations is reduced to one only – the parameter  $s_{11}$  – which will be easy to calculate, as  $a_2$  and  $b_2$  will be zero. The parameter  $s_{11}$  is directly related to the VSWR value or the reflection coefficient (refer also to Figure 80 B).

## 4.2 PRACTICAL MEASUREMENTS

The practical measurements have two purposes; to show how and why measurements are performed. At the same time, transmission theory and component features are integrated. There are several common factors when speaking about RF connectors, which are usually mentioned in either the specifications, standards or in connector catalogues. But what do these quantities mean and how are they determined or verified?

One important thing to remember when reading the electrical specifications in the HUBER+SUHNER Coaxial Connector General Catalogue is that the quantities mentioned are always per connector. However, the measurement of RF connectors on a vector network analyser usually requires a pair of connectors to be able to perform as a real transmission line. Depending on the connectors to be measured, either a female (jack) or a male (plug) is terminated to port 1 along with a male or a female at port 2. Additionally, the result of a measurement, e.g. the reflection (return loss  $R_1$ ), must always be interpreted as the total sum of reflection produced from each component.

In this section, we will make a soft transition from theory to practice, so that people with no or little knowledge of test and measurement techniques will also have the opportunity to better understand the specifications and the measurement procedures. As it is possible to choose and carry out various measurements to test electrical performance, only three common examples are selected. Each of them measures one of the following factors:

- |                |                                                                                                           |
|----------------|-----------------------------------------------------------------------------------------------------------|
| Example No. 1: | Transmission factor or<br>Insertion loss [ $s_{21}$ ]                                                     |
| Example No. 2: | Reflection factor [ $r$ ] or<br>Return loss [ $a$ ] or<br>VSWR (voltage standing wave ratio) [ $s_{11}$ ] |
| Example No. 3: | Passive intermodulation level (PIM)<br>(a frequency selective power measurement)                          |

The one-port network is mainly coupled with a two-port network (Figure 82). A source or a termination are one-port networks. When it is connected to port 2 at the DUT, port 2 at the VNA will not be used. This method is often used when only the reflection coefficient is desired.

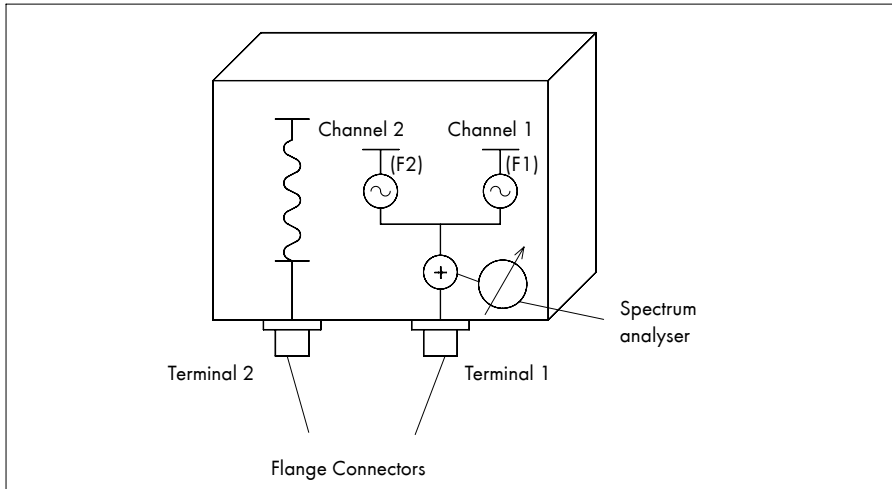

Figure 82 Simplified view of PIM test set-up

Before we start describing the examples, the importance of calibration, the procedure and error contributors are shortly outlined. After that, the above factors will naturally be explained according to measurement parameters and results. A photograph or a drawing of the test components will be shown before the definition of the DUT. Overall diagrams or photographs of the test set-ups on site will then be followed by description of procedure and test result(s).

#### 4.2.1 Calibration of Basic Test Set-up

In brief, calibration<sup>1)</sup> is the process of transferring the accuracy of a standard [read standard specification of a component] to a practical measurement system. That is, the errors detected in the vector network analyser (VNA) will be “compensated” for by the calibration, so that the measurement of the DUT only displays the reflection or any other coefficient of the DUT itself and not of the whole test set-up. In the following examples the calibration is assumed to be accurate.

The measurement quality depends not only on the quality of the connector pair measured (DUT), but also on interactions arising at the connector interface between the test port and the DUT. The test port connectors and adaptors used for the measurements should have a precision interface design. The reason is that an imperfect socket-to-pin contact between the adaptors and that between test port connectors or adaptors and the DUT can lead to inaccuracy. Usually, the test port components (precision connectors, the precision adaptors or the terminations, e.g.  $50\ \Omega$ ) are specified to certain quantities (refer also to calibration example below). Any negative divergence from these standard specifications affects the wave propagations, e.g. reflections deriving from an incorrect diameter of the male pin or an excessive pin depth. These waves are calibrated out (losses subtracted). However, the deviation waves or departures from the standard are also calibrated in and cannot be compensated for later on. Other defects causing varying mismatches could be inadequate concentricity, poor surface finish, dirt and low contact pressure.

Additionally, when a test port adapter is added to the basic test set-up after calibration, it will be an extra contributor to losses and measurement errors. To avoid or minimise those errors in the final test set-up, all test port compo-

nents should preferably be as perfect as possible and all should be included in the calibration procedure. If the interface of both test port components and everything else is perfectly designed and optimised, the measurement system can theoretically be considered as ideal. But the world is unfortunately not perfect. The first errors occur when the DUT is attached to the test ports. Any deviation, e.g. inductive pin gaps or seams existing at the test port interface or occurring by mating the DUT with the test port components, will lead to faulty performance and inaccurate measurements. It will not be possible to subtract all mismatches beforehand, because every error can not be discovered or taken into consideration by the VNA or the person who carries out the measurement. But it is important to know what may influence the measurement result.

Some errors always exist as “invisible” risks, which makes the calibration procedure rather complex. Despite the “perfect” precision test port components and a seamless DUT, the DUT measurement would still show mismatches because the interface contact would probably not be lossless anymore. However, if every measurement is done with the same “perfect” calibration components, i.e. inner contact assumed to be seamless, all measurements would agree. Accordingly, the following calculation of S-parameters does not contain any error correction.

1) The whole calibration procedure will not be described here in detail, as it is usually done automatically by a programmed vector network analyser.

The Open-Short-Load calibration (called OSL) is done in four steps:

1. An “open” is connected to port 1 while a “short” is terminated to port 2 (separate devices)
2. Then a “short” is connected to port 1 while an “open” is terminated to port 2
3. Finally, each port is connected to a termination, a “load” (separate device)
4. A connect-through is established – by connecting the two adaptors

## 4.2.2 Measurements of Reflections and Transmission

The three practical examples below all include coefficients or factors that have been described partly in this chapter and partly in the first chapter. That is, the theory of parameters has not yet been linked directly to the practical measurement procedures and results. Therefore, the following descriptions will explain the connection between the desired features and the results displayed on the analyser screen.

### Return loss, VSWR and reflection factor

It is possible to quantify the reflection factor by using either the one-port or the two-port method. If only the reflection coefficient is desired, the one-port network – including the termination – is sufficient for the purpose. When port 2 is perfectly matched, the only parameter measured is the  $s_{11}$ , which is the actual reflection. The two-port network will include all the scattering parameters –  $s_{11}$ ,  $s_{12}$ ,  $s_{21}$  and  $s_{22}$  – which can be defined directly by a vector network analyser. Today’s VNAs allow the reflection quantity to be displayed in many different forms at the push of a button.

Normally, when the reflection coefficient is displayed on the analyser screen, it is expressed as a return loss  $R_L$  (designated [dB]) within a chosen frequency range. For instance, a test result shows –23.69 dB from DC to 4 GHz. The stated quantity will always be the highest quantity on the curve shown, considered as the “worst case”. (Please refer to the first test result below.)

If the result is desired as a voltage standing wave ratio (VSWR) quantity, the return loss can be converted. This is done by using the conversion table in the formula book or the conversion equation from table 1.3.4 on page 29. The VSWR would in this case be 1.14 (without unit) instead of –23.69 dB. Furthermore, the reflection can



be expressed as a reflection coefficient (also called reflection factor), which would have a value of 0.065 (without unit).

#### Transmission coefficient and insertion loss

The transmission coefficient tells how high the output voltage is in comparison to the input voltage. In other words, it is the transmitted voltage that will travel through the system line. For passive components like connectors, the transmission coefficient can never be more than 100% of the input voltage (refer to Figure 22 in Chapter 1, on page 24). That is why this factor is also referred to as the insertion loss (expressed in dB).

However, regarded as a measurement parameter, the transmission coefficient is equivalent to the parameter called  $s_{21}$ . Defined by waves or terminals, it is then the ratio of the output signal to the input (applied) signal.

### 4.2.3 Example No. 1: Return Loss and Insertion Loss of an SMA-Assembly

In the first example, two of the SMA specifications in the HUBER+SUHNER Coaxial Connectors General Catalogue, return loss and insertion loss, will be tested. It might be the case if a cable or a connector has to be replaced in an application or if the assembly has been exposed to a temperature shock test. In this example, let us say that the application is an external interconnection between two subsystems (refer also to connection type No. 6 in Chapter 3.2 [page 63]). After the test, each of the two  $50\ \Omega$  SMA connectors, of course with the cable in between, will be mated with a counterpart (an SMA flange type) placed on an equipment section.

The DUT is an assembly consisting of the two SMA connectors and a flexible cable (see Figure 83), which is measured up to the absolute maximum frequency of the system components, about 12.4 GHz. However, the transmitted frequency of the system line is maximum 5 GHz.



Figure 83 Photograph of DUT No. 1 with SMA connectors and the test port adaptors (SMA-PC7)

#### The DUT components and the given specifications (typical quantities):

HUBER+SUHNER connector types:

<b>21 SMA 50-3-5c</b>	<b>Straight socket connector with gold plating on CuBe2.</b>
<b>16 SMA 50-3-5c</b>	<b>Right angle pin connector with the same plating as the 21 SMA.</b>

Specifications for SMA connectors attached to flexible cables:

<b>Frequency range:</b>	<b>DC to 12.4 GHz</b>
<b>VSWR:</b>	<b>1.10 + 0.010 f [GHz] (for straight connectors)</b>
<b>VSWR:</b>	<b>1.10 + 0.020 f [GHz] (for right angle connectors)</b>
<b>Insertion loss:</b>	<b>0.15 × √ f [GHz] dB (caused by cable length)</b>

Cable: RG 58/U

<b>Cable dielectric diameter:</b>	<b>1.5 mm</b>
<b>Frequency range:</b>	<b>DC to 5 GHz</b>
<b>Length:</b>	<b>Approx. 200 mm</b>

At first, the VNA has been calibrated accordingly at the end of the test cables and the SMA adaptors using various standard components. The calibration procedure typically ends with a through-connection, where the test ports (here at the end of the two test cables) are connected to each other. This establishes the remaining error vectors in the VNA. The test set-up below looks similar to that of the PIM test set-up (see Figure 82 on page 114 and Figure 90 on page 128).

However, if the calibration procedure runs smoothly, the information on the basic condition is saved by the VNA memory and the quantity of losses will be reset to zero (reference level) at both ports. Before proceeding, a “known” good component (e.g. a precision airline) should be connected to verify the quality of the calibration.

Secondly, all DUT components have been selected, carefully cleaned and finally assembled with the chosen cable. It is important that the cable assembly is assembled correctly and with extreme care. The components must not be assembled with dirty hands or gloves. In addition, refrain from kinking the cable to shorten it or something similar. If the components are being incorrectly handled, the whole test might provide an erroneous and unreliable result. Naturally, the same applies to test cables and adaptors.

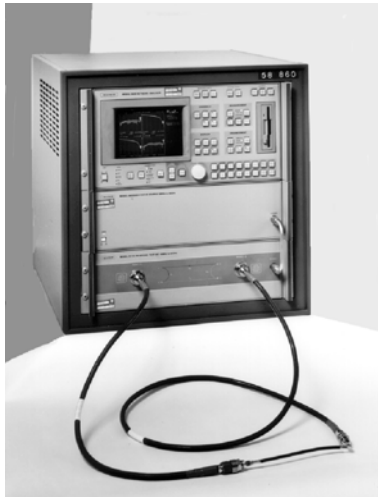

Figure 84 Photograph of test set-up No. 1 with SMA assembly

Finally, before the DUT is connected to the test ports, its pin depths must be checked to prevent mechanical destruction of either the DUT or the test ports. Refer to the recommendations for measurement procedures in the section on dos and don'ts on page 133.

As shown in the photograph above, the test set-up is now completed with the termination of the DUT to the VNA. The 21 SMA is coupled to port 1 and the 16 SMA to port 2.

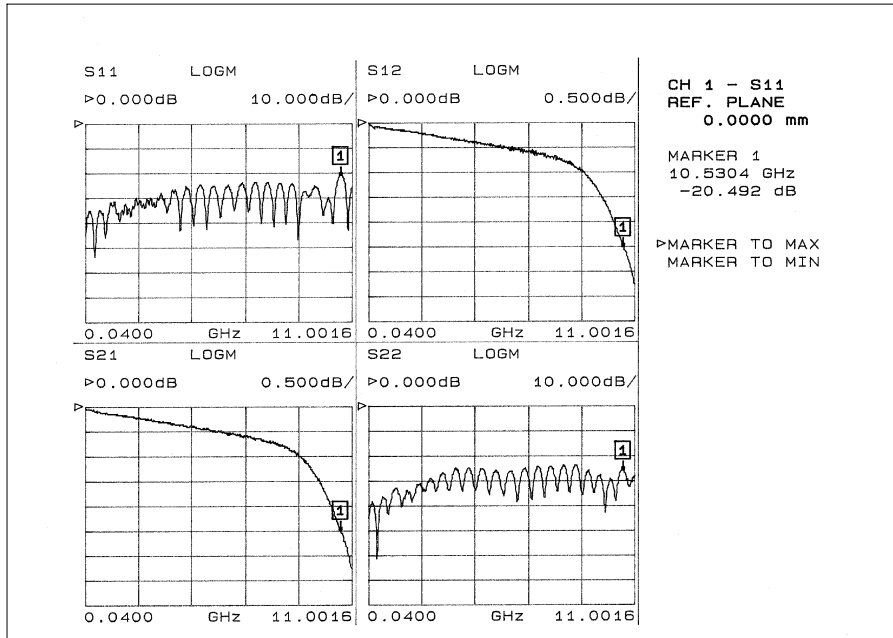

Figure 85 Result of test No. 1 - related to frequency

The VNA marker is told to display the “worst case” quantities of the return loss  $s_{11}$ . At the same time, the graphs of the insertion loss,  $s_{21}$ , the output-reflection coefficient  $s_{22}$  and the reverse-transmission coefficient  $s_{12}$  will be defined in the frequency range from DC to 11 GHz.

The organisation of the screen display is also indicated, so that all four diagrams are displayed simultaneously. After the analysis process has been carried out, the diagram with the determined “worst case” quantity for  $s_{11}$  (marker No. 1) is displayed on the screen (refer to Figure 85, above left). The marker No. 1 in the rest of the diagrams does not indicate any “worst case”, but is automatically found at random by the VNA.

Please keep in mind that the cable is not specified to perform up to 12.4 GHz, only 5 GHz, thus being the restricting component in the whole assembly. It means the result must not be interpreted to be in the frequency range DC to 12.4 GHz, but from DC to 5 GHz, which is the correct frequency range for the assembly. The specified quantities – as functions of the frequency – have to be calculated at the maximum frequency, which is indicated below.

To convert the quantities into other reflection factors (see below), the correct equations can be found in the conversion table in Chapter 1.3.4 (page 29).

HUBER+SUHNER specifications at 5 GHz:

## 21 SMA:

1A.		VSWR	$\geq 1.10 + 0.010 \times 5$ [GHz]
	$\Leftrightarrow$	VSWR	$\geq 1.15$
2A.	converted into	Reflection coefficient	$\geq 0.0695$

## 16 SMA:

2A.		VSWR	$\leq 1.10 + 0.020 \times 5$ [GHz]
	$\Leftrightarrow$	VSWR	$\leq 1.20$
2B.	converted into	Reflection coefficient	$\leq 0.091$
3.		Insertion loss	$\leq 0.15 + \sqrt{5}$ [GHz]
	$\Leftrightarrow$	Insertion loss	$\leq 0.335$

Please note that the two VSWR quantities, specified for the 16 and 21 SMA, both contribute to the total reflection. To be able to compare the given quantities with the test result, they must be summed up. Then the sum corresponds to the total reflection of the cable assembly. The VSWR quantity specified for the cable is regarded as nearly ideal (almost 1.0). Therefore, it is not integrated in the calculation, as it contributes to the total reflection with a very negligible value.

Test results (indicated by the diagrams in Figure 85):

The lowest point or the highest reflection value is found at 10.53 GHz by marker number 1, which will be indicated automatically by the VNA. However, the correct test results for the cable assembly are indicated up to 5 GHz (maximum system frequency):

4. Return loss  $s_{11}$  = 25.00 dB  
 5. Insertion loss  $s_{21}$  = 0.49 dB

Return loss can be converted into the following coefficients:

6. VSWR = 1.112  
 Reflection coefficient = 0.053

By the following correct equations or statements in Table 34, we conclude from the test that the measured DUT, the SMA cable assembly, fulfils the reflection specifications satisfactorily:

Coefficient		Measured value		Specified max. value (approx.)
Return loss	=	25.00 dB (4)	$\geq$	$20 \log (1/(0.0695+0.091))$ dB* (2A & 2B)
	=	25.00 dB	$\geq$	$20 \log (1/0.1605)$
	=	25.00 dB	$\geq$	15.89 dB
VSWR	=	1.112 (6)	$\leq$	$(1 + 0.1605) / (1 - 0.1605)$ (1A & 1B)
	=	1.112	$\leq$	1.38
Insertion loss	=	0.49 (5)	$\leq$	0.335 (3)

Table 34 Table 1 Test results held up against specified SMA quantities

\* Note: The return loss is found by using the specified VSWR values expressed as reflection coefficients, because two VSWR quantities cannot be added and converted into dB directly.

The two SMA connectors can now be used in the application without problems, as they can perform to at least the specified spectrum loss quantities.

In the example below, a parameter equation is been calculated to show how it is found by using the input quantities.

#### A calculation check by the use of S-parameters:

Input voltage $a_1$	=	1 V
Output voltage $b_2$	=	0.945 V
Reflected output voltage $a_2$	=	0 V
Reflected input voltage $b_1$	=	0.056 V
Reverse-transmission coefficient $s_{12}$	=	0.49 dB
Output-reflection coefficient $s_{22} = s_{11}$	=	25.00 dB

Results viewed from port 1 (16 SMA):

Return loss:	=	$b_1/a_1$ (positive dB)	
	=	$1/0.056$	
	=	$17.86^*$	
	=	$20 \log (17.86)$ dB	= 25.00 dB

---

Insertion loss:	=	$b_2/a_1$ (positive dB)	
	=	$1/0.945$	
	=	$1.058^*$	
	=	$20 \log (1.058)$ dB	= 0.49 dB

---

\* The quantities are the reflection coefficients, which are converted into return loss and insertion loss values, respectively.

Note: No error correction is included in the S-parameter calculations, because it will make them too complex and it will by far exceed the scope of this booklet.

#### 4.2.4 Example No. 2: Return Loss of an N-Assembly

In this case the one-port method is chosen, because the desired coefficient only is the reflection or return loss of the transmission line. The application problem is that a customer wants connectors that can withstand severe environmental conditions and still perform almost as the two existing standard N connectors with SUCOPLATE plated beryllium copper housings. Instead, N connectors with stainless steel housings are applied.

This measurement is carried out to check whether these connectors can perform as well as the replaced ones and fulfil the standard specification for VSWR.



Figure 86 Photograph of DUT No. 2 with N connectors and 50  $\Omega$  termination (left)

The DUT components and the given specifications (typical quantities):

HUBER+SUHNER connector types:

<b>11 N 50-3-51</b>	<b>Straight pin connector with gold plating on CuBe2 inner conductor and housing of stainless steel</b>
<b>21 N 50-3-51</b>	<b>Straight socket connector with the same plating as the 11 N</b>
<b>(and a HUBER+SUHNER 50 <math>\Omega</math> termination)</b>	

Specifications : Impedance: 50  $\Omega$

<b>Frequency range:</b>	<b>DC to 12.4 GHz</b>
<b>VSWR:</b>	<b>1.03 + 0.004 · f [GHz]</b>
<b>(applied for both N connectors)</b>	

Cable: Semi-Rigid EZ 141

<b>Frequency range:</b>	<b>DC to minimum 18 GHz</b>
<b>VSWR:</b>	<b>1.25 from DC to maximum 12.4 GHz</b>
<b>(for Semi-rigid cable assembly with N connectors)</b>	
<b>Length:</b>	<b>Approx. 200 mm (7.874 inches)</b>

At first, the calibration of the VNA. Refer also to calibration procedure generally and to the first example.

The connectors and the cable are carefully fitted to a cable assembly (DUT) and finally terminated to the VNA, which is seen in the background of the photograph above (see Figure 87). The 11 N is attached to port 1 and 21 N is terminated using a suitable termination (here 50  $\Omega$ ).

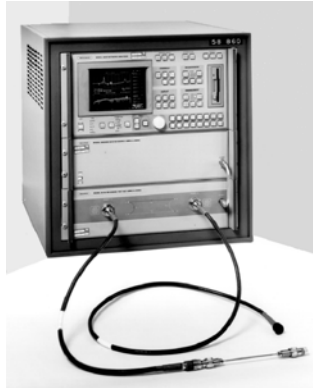

Figure 87 Photograph of test set-up No. 2 with N assembly

The VNA has of course been calibrated (matched to zero) with the measurement cables, adaptors and the termination, thus it is ready for measuring the connectors in the DUT by the one-port network method. By this the difference is tested and not the combination of DUT and the measurement equipment.

When the DUT has been coupled, the VNA measures and shows the forward reflection coefficient  $s_{11}$ , both as a function of time (pico-seconds) and frequency (GHz). When the measurement is desired as a function of time, the time domain option of the VNA has been chosen. It allows the operator to view where along the DUT reflection components are contributing to the sum of all reflections. The conversion or transformation of data from the frequency domain into the time domain means that the data will be changed from e.g. reflection vs. frequency to reflection vs. time or, via wave propagation velocity, distance (Fourier transformation).

The desired gating or section of the transmission line is to be determined by the user. Gating is understood to mean the "isolation of a selected section" of the DUT, which is localised by the VNA as a gate. Thereby, the time domain measurement neglects the reflections from the rest of the line and only the selected area is measured. In the next example, the DUT has been gated, so that the reflections emerging from the connectors 11 N and 21 N and the cable can be found and displayed as shown in the upper graph in Figure 88. Note: The measurement result of an ideal DUT would be a straight line in the time domain.

The cable assembly consists of two solder captivations of the inner conductors and two soldered cable entries. It means that there are two junctions or contacts at each end creating reflections. The reflection coefficient, which is expressed in milliunits ‰, is the result of varying impedance caused by mismatches (i.e. gaps or diameter changes). The mismatch may be increased by such factors as poor surface finish/plating, dirt and low mating torque.

The highest peaks in the graph (shown in Figure 88, above) are the reflections occurring at the cable entry and the inner conductor contact. The lower peaks at the far left and far right are reflections produced inside the connectors 11 N and 21 N, respectively.



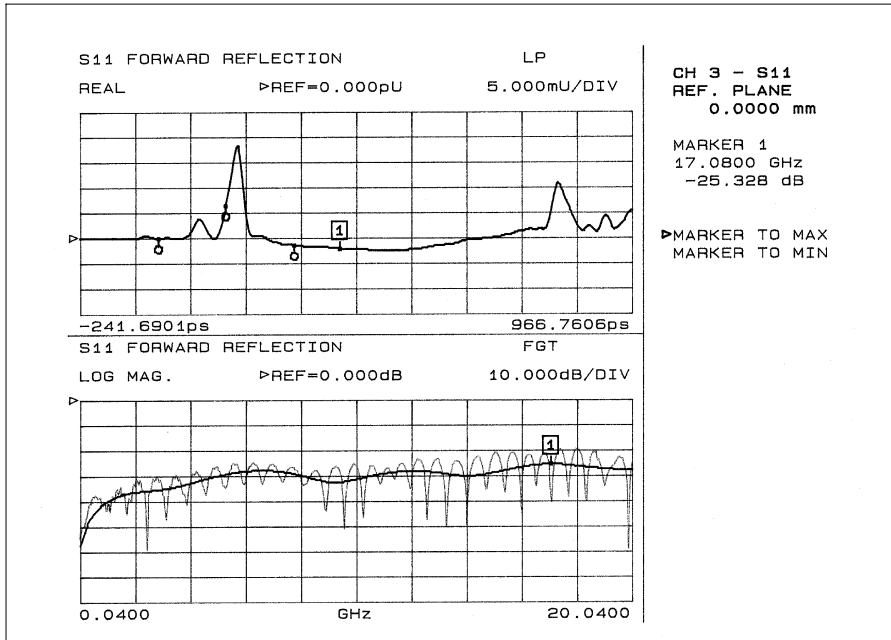

Figure 88 Result of the test No. 2 - related to time (pico-seconds) and frequency

Note: Straight line = 11 N gated (gated connector section marked with circles ○)  
Curved line = Cable assembly including termination (real values)

Point 1 detected in the graph at the bottom (frequency domain) is the highest reflection point discovered by the VNA. Furthermore, the placement of the worst reflection peak point is found in the 11 N connector in the time domain, whereas the 21 N does not provoke such high reflection waves.

The analyser automatically found the lowest or the “worst case” for the DUT. In this case the lowest point found is the quantity 25.33 dB up to 17.08 GHz. This is not the correct result because the graph primarily indicates the absolute performance limit from DC to 18 GHz. The correct frequency range for this example is DC to 12.4 GHz.

HUBER+SUHNER reflection values specified from DC to 12 GHz for each connector:

11 or 21 N:	VSWR	≤	1.03 + 0.004 × 12 GHz
	VSWR	≤	1.078
converted into	Reflection coefficient	≤	0.0375
converted into	Return loss	≤	-28.40 dB

Please note that the VSWR quantities, specified for the 11 and 21 N, contribute to the total reflection of the cable assembly. The sum of the two values will be compared with the test result. The VSWR quantity specified for the

semi-rigid cable is regarded as nearly ideal (almost 1.0). Therefore, it is not integrated in the calculation, as it only contributes to the total reflection with an insignificant value.

Displayed result of the gated section (approximate values):

Return loss	=	-25.3 dB measured in the range from DC to 17.08 GHz
VSWR	=	1.114
Reflection factor	=	0.054

Correct result of the gated section, indicated up to 12.4 GHz for the 11 N (approximate values):

Return loss	=	-28.50 dB
VSWR	=	1.077
Reflection factor	=	0.038

Correct result indicated from DC to 12.4 GHz for the whole assembly (approximate values):

Return loss	=	-24.50 dB
VSWR	=	1.126
Reflection factor	=	0.059

To compare the indicated results with the specifications, Table 35 and Table 36 below show parts of the calculation steps made to convert the values for the 11 N alone and for the whole assembly.

Coefficient	Measured value		Specified max. value (approx.)
Return loss	= -28.50 dB	≥	20 log (1/0.038) dB*
	= -28.50 dB	≥	-28.40 dB
VSWR	= 1.077	≤	1.078
	= 1.077	≤	1.078

Table 35 Table 2 Test results compared with specified 11 N 50-3-51 reflection quantity

\*Note: The return loss is found by using the specified VSWR values expressed as reflection coefficients, because a VSWR quantity cannot be converted into dB directly.

Coefficient	Measured value		Specified max. value (approx.)
Return loss	= -24.50 dB	≥	20 log (1/(0.0375 + 0.0375)) dB*
	= -24.50 dB	≥	20 log (1/0.075) dB
	= -24.50 dB	≥	-22.49 dB
VSWR	= 1.126	≤	0.0751
	= 1.126	≤	1.162

Table 36 Table 3 Test results compared with specified N quantities (assembly)

\*Note: The return is found by using the specified VSWR values expressed as a reflection coefficient, because two VSWR quantities cannot be added and converted into dB directly.

The conclusion drawn from these results is that the N connectors with the stainless steel housing are able to perform to the specified values of VSWR. The customer can replace the existing connector and expect to obtain the specified electrical performance with this connector pair.

A correct result is obtained when calculating with the limiting frequency range of the connector, as it gives the right frequency (transmitted frequency) for the whole system. Again: Do not calculate the maximum frequency of the connector or the cable only, but always to the optimum frequency level of the whole system.

The component in the system with the narrowest frequency passband to which the component is specified will be the limiting and the highest allowable factor and will be decisive for the frequency of the system. Otherwise, the risk is high that weak or vanishing signals might render a system unable to operate to the specifications it has been designed for.

#### 4.2.5 Measurement of Passive Intermodulation Level (PIM)

In mobile communication systems with high power transmitters and very sensitive receivers collocated to each other, passive intermodulation products (PIM) can be a problem. It has been known for some time that theoretically linear components may exhibit a certain degree of non-linearity. In case of two or more signals of different frequency, a non-linear component will perform an unwanted mixing function, causing IM signals to appear. Should one or more of those fall into the receiving band, it can block a channel, thus reducing system capacity. Therefore, PIM must be reduced as much as possible.

When testing the PIM level produced by the passive components, the worst case has to be determined, i.e. the highest PIM level of the DUT in comparison to the customer specified level.

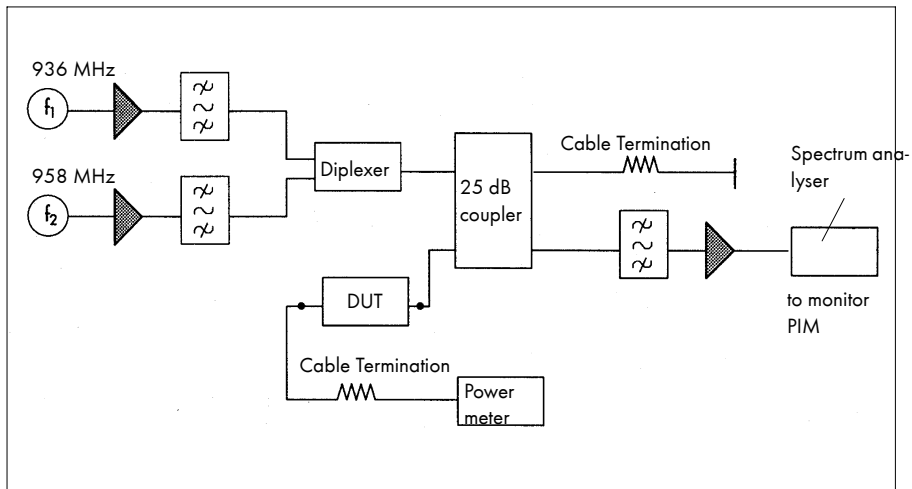

Figure 89 Schematic diagram of PIM test set-up (GSM, 900 MHz system)

Typical block diagram of a test set-up for measuring the quantity of passive intermodulation products (PIM) is shown above in Figure 89. The practical test set-up (refer to Figure 82 and Figure 90) looks somewhat different, as the test components and DUT are the only components visible.

The following example with an intermodulation measurement is intended for readers who want to know more about intermodulation problems, e.g. how coaxial cable assemblies are tested, and how much they contribute to the passive intermodulation level of a transmission system.

#### 4.2.6 Example No. 3: Passive Intermodulation

As the build-up and implementation of mobile communication equipment has taken off in the last couple of years, an example with a cable assembly typically used for this kind of application has been chosen. A customer wants to apply a 7/16 cable assembly as a feeder transmission line from a mobile base station to an antenna power splitter. The assembly has to fulfil a maximum PIM performance of -115 dBm to avoid any disturbances or signal interruptions. The cable assembly will consist of two 7/16 coaxial connectors and a 1¼" corrugated cable, which will be the DUT in the measurement example.

Before the DUT is terminated to the intermodulation (IM) test set-up, it is very important that the test set-up with the measurement cable and the adapter (test port components) is properly calibrated. All test port components must also be of particularly low-intermodulation design. The reason is that the reference level of PIM produced by the equipment should be checked and minimised. This is done because of the uncertainty as to the existence of component errors and to ensure to the reliability of the measurement result.

The test set-up is tested to a passive intermodulation level of maximum -175 dBc (power ratio to carriers,  $f_1$  and  $f_2$ ), which is also called the residual intermodulation level. The carriers or signal sources are indicated in Figure 89, which shows the PIM test set-up.

The DUT for the PIM measurement consists of the following components:

Connectors:

<b>HUBER+SUHNER types;</b>		
<b>11 716 50-32-1</b>	<b>Straight pin connector</b>	<b>(Port 1)</b>
<b>21 716 50-32-1</b>	<b>Straight socket connector</b>	<b>(Port 2)</b>
<b>(+ HUBER+SUHNER 50 Ω termination for 7/16)</b>		
<b>Max. frequency: 7.5 GHz</b>		

Cable:

**Corrugated cable 1¼"**  
**Max. frequency: 18 GHz**  
**Length: approx. 200 mm (7.874 inches)**

The cable entry at both connectors is based on a clamp/screw-on outer conductor technique, because it is proven that this kind provides dynamic and static intermodulation performance.

Note: A crimp version would probably result in a higher intermodulation level, as it is not stable mechanically. Therefore, crimps should be avoided in intermodulation sensitive applications.

When the analyser and the test components have been calibrated, the DUT is terminated. As with the components to be calibrated, DUT components also have to be carefully checked and cleaned for the measurement. The test set-up ready for the PIM measurement is shown below.

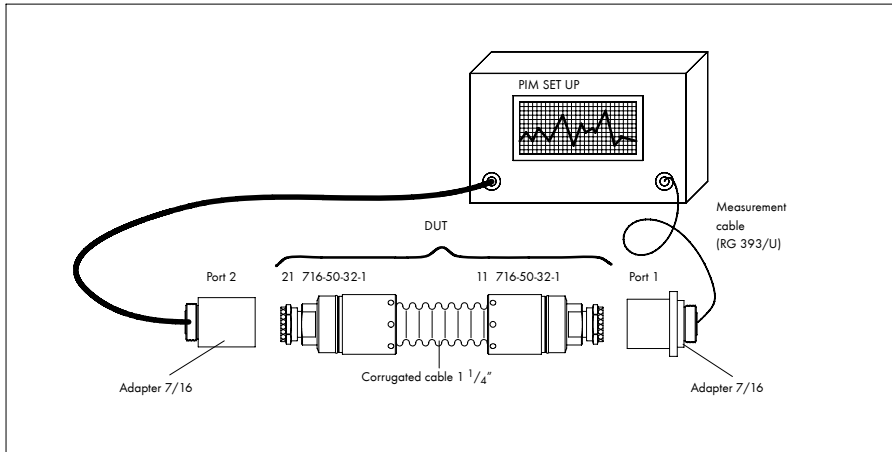

Figure 90 IM test set-up with 7/16 DUT

For 800/900 MHz mobile communication systems, the test signals  $f_1$  and  $f_2$ , are 958 and 936 MHz, respectively. The resulting  $f_{im3}$  will be at 914 MHz, which falls into the receiving band. The power level of the two carriers is 20 watts or +43 dBm. 1 milliwatt of power is equal to 0 dBm. Furthermore, the sensitivity of the receiver equipment (GSM system or equivalent), is specified to be -103 dBm and the permissible PIM performance level to max. -115 dBm by the customer. However, the correct customer PIM specification would be +158 dBc (115 dBm +43 dBm equal to +158 dBc). The magnitude of the receiver sensitivity tells that the disturbance signals (PIM) must be lower due to the risk of signal interference in the receiver band. However, here we want to achieve a maximum value of -120 dBm.

First, the test will show a PIM result determined at the intermodulation frequency of the mixed 3rd-order PIM or  $F_{im3}$  (refer also to Chapter 1.6 on page 36), which is a sum of the two test frequencies:

$$\begin{aligned}
 F_{im3} &= 2 \cdot f_2 - f_1 \text{ [MHz]} && (= \text{3rd-order PIM}) \\
 F_{im3} &= 2 \cdot 936 - 958 \text{ [MHz]} \\
 F_{im3} &= 914 \text{ [MHz]}
 \end{aligned}$$

The frequency  $f_{im3}$  is the expected signal arising from non-linear behaviour of the components tested.

The test result related to the frequency is indicated in a static measurement, in the range of the expected IM frequency  $f_{im3}$ .

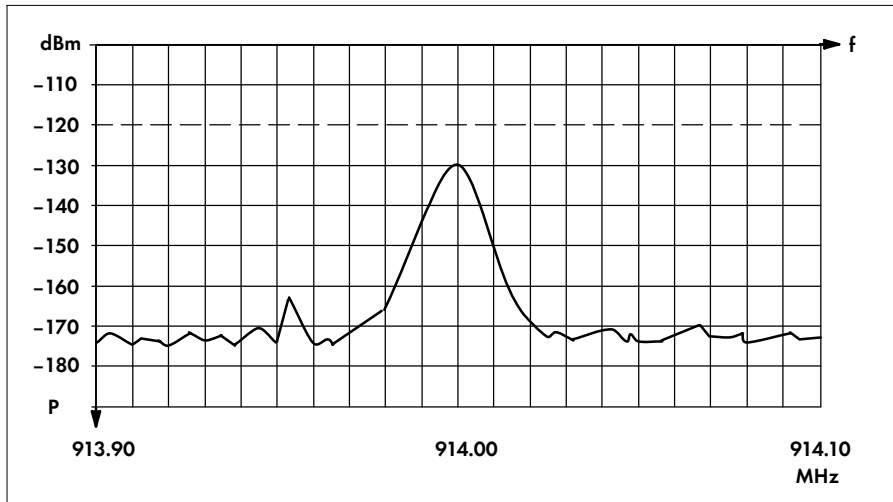

Figure 91 Result of the PIM measurement – related to frequency

In Figure 91, the graph indicates that the PIM level is well below the internal specified intermodulation performance of  $-120$  dBm. In fact, the PIM peak does not exceed  $-130$  dBm or, related to power level, the signal-to-noise ratio  $173$  dBc.

However, intermodulation is often caused by a dynamic or microscopically unstable behaviour resulting from varying contact pressure due to temperature variations, vibration, mechanical loading, ageing or a lack of cleanliness during assembly. The result related to  $f_{im3}$  does not indicate “real” values or maybe not the peak values that can occur after the final installation in the system, but only a somewhat random value.

Higher intermodulation peaks may occur due to some of the above-mentioned influences, and they might occur outside the narrow time range when the frequency sweep passes the  $f_{im3}$  at  $914$  MHz. Therefore, the only way to discover those is to switch over from frequency to a time domain section (dynamic testing). This can be done automatically by choosing the option for this on the spectrum analyser, as described in test example number 1 on page 119.

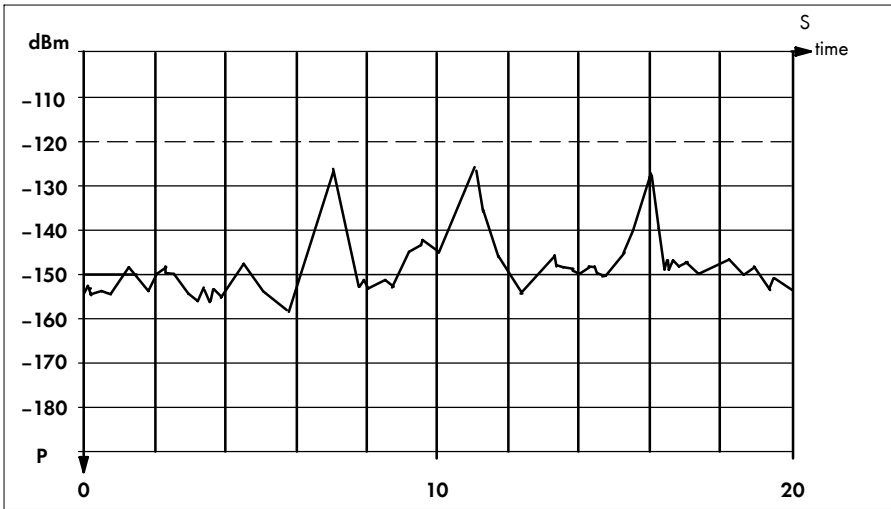

Figure 92 Result of PIM measurement – related to time (time domain in seconds)

While the spectrum is set to zero span, the DUT is mechanically stressed to verify the stability of all contact points within the DUT. As it can be seen in Figure 92, the mechanical stress induced at 7, 11 and 16 seconds created more non-linear conditions than during the other times. This can now be further analysed for remedy if required.

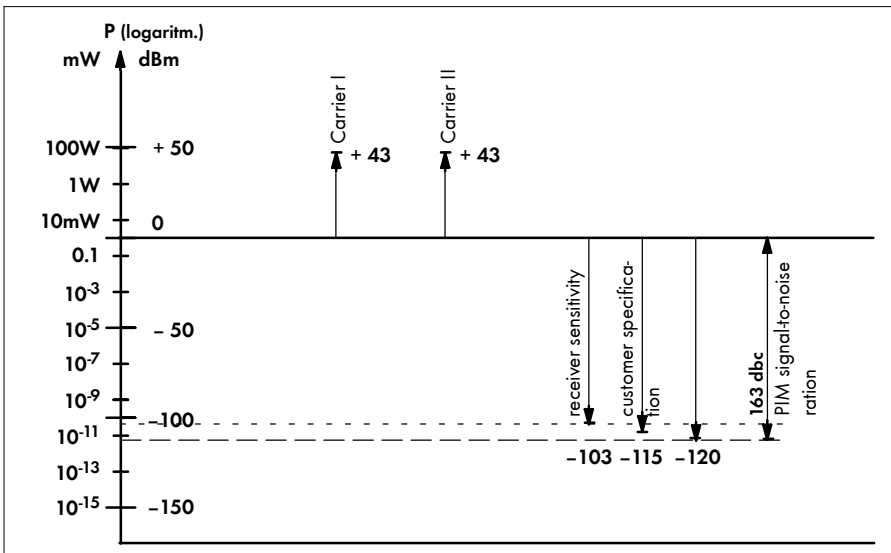

Figure 93 Power relations in the PIM measurement example

The dynamic testing result (Figure 92) indicates that the IM signal does not exceed the limit of  $-120$  dBm. The worst peak point between 0 and 20 seconds is discovered at about  $-125$  dBm. Therefore, the permitted customer value of maximum  $-115$  dBm is obtained satisfactorily. The view of power levels, frequencies and PIM signals may seem a little chaotic. Therefore, the graph in Figure 93 should help you understand the total result of the power relations and PIM test.

The power relation figure indicates the two intermodulation signal-to-noise ratios between the power level and specified customer PIM level and the HUBER+SUHNER PIM level, respectively. The customer permitted PIM signal-to-noise ratio, which the DUT is expected to meet beforehand, should be less than  $158$  dBc. In Figure 93, the distance to the customer intermodulation level is less than the obtained or guaranteed level of  $163$  dBc, which then gives a safety margin of  $+5$  dBc.

To be sure that the dynamic testing is still correct and that the performance test result provides a stable PIM value of less than  $-120$  dBm, the assembly is normally exposed to a rigorous environmental test programme. The cable assembly must be able to endure such influences without producing additional and continuous signal disturbances in the final installation.

Between and after these tests, the assembly will again be measured for PIM. At the same time, it is tapped with a nylon mallet to test sudden shock reaction. The final results are also related to the time domain, as shown in Figure 94 below.

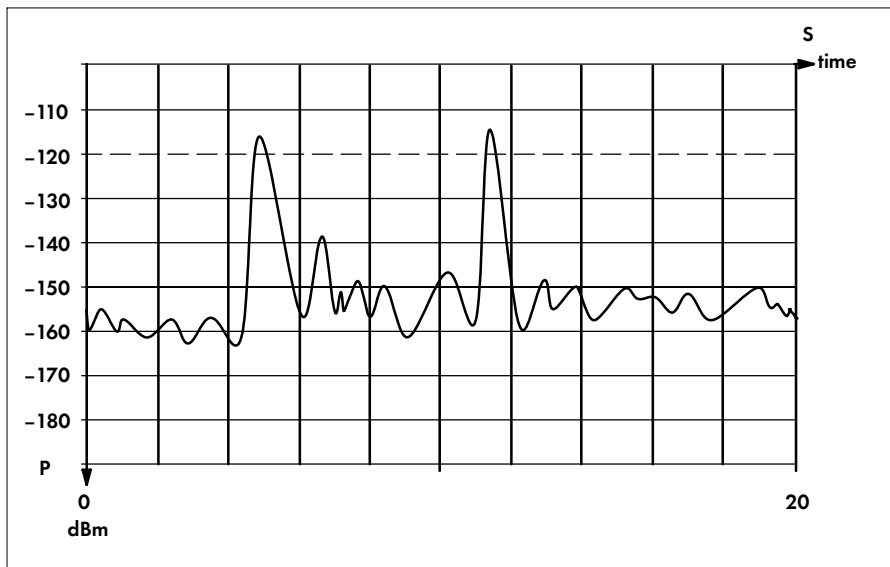

Figure 94 PIM levels after environmental tests – in time domain

Figure 94 shows that the environmental tests alone do not influence the peak PIM level, and that taps with the nylon mallet influence the peak level negatively in two instances. However, the tapping produces spikes (peaks), after which the PIM signal disappears. The conclusion is that the guaranteed PIM signal-to-noise-ratio of  $-163$  dBc still fulfils the requirements.



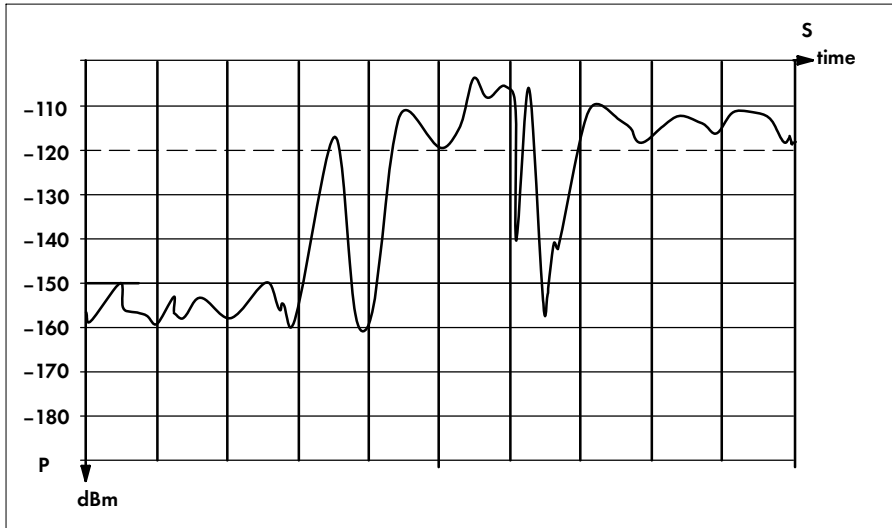

Figure 95 Unstable PIM behaviour after a tap test

In addition Figure 95, we show you a result of an unstable PIM behaviour after environmental tests in. If the upper PIM peaks, caused by any shock or vibration influence, are continuous, or if the level increases to above - 115 dBm more often, the behaviour must be concluded to be very unstable. In other words, the connectors would not live up the permitted requirements set by the customer.

## 4.3 DOS AND DON'TS

This section contains a brief list of what to be aware of when preparing measurements with regard to proper care and handling of RF coaxial connectors.

PRINCIPLES OF	DOS	DON'TS
Handling and Storage	<ul style="list-style-type: none"> <li>Do keep connectors clean</li> </ul>	<ul style="list-style-type: none"> <li>Don't touch mating plane surface</li> </ul>
	<ul style="list-style-type: none"> <li>Do extend sleeve or connector nut</li> </ul>	<ul style="list-style-type: none"> <li>Don't set connectors contact-end down</li> </ul>
	<ul style="list-style-type: none"> <li>Do use plastic end caps during storage</li> </ul>	<ul style="list-style-type: none"> <li></li> </ul>
Visual Inspection	<ul style="list-style-type: none"> <li>Do inspect all connectors carefully before every connection</li> </ul>	<ul style="list-style-type: none"> <li>Don't ever use a damaged connector</li> </ul>
	<ul style="list-style-type: none"> <li>Do look out for metal particles, scratches, dents, burrs, etc.</li> </ul>	<ul style="list-style-type: none"> <li></li> </ul>
Cleaning	<ul style="list-style-type: none"> <li>Do try compressed air first</li> </ul>	<ul style="list-style-type: none"> <li>Don't use any abrasives</li> </ul>
	<ul style="list-style-type: none"> <li>Do use pure liquid Freon (denatured alcohol)</li> </ul>	<ul style="list-style-type: none"> <li>Don't get liquid onto plastic support beads</li> </ul>
	<ul style="list-style-type: none"> <li>Do clean connector threads</li> </ul>	<ul style="list-style-type: none"> <li></li> </ul>
Gauging (Measuring)	<ul style="list-style-type: none"> <li>Do clean and zero the gauge before using</li> </ul>	<ul style="list-style-type: none"> <li>Don't use an out-of-specification connector</li> </ul>
	<ul style="list-style-type: none"> <li>Do use correct gauge type</li> </ul>	<ul style="list-style-type: none"> <li></li> </ul>
	<ul style="list-style-type: none"> <li>Do use correct end of calibration block. Do check interface dimensions</li> </ul>	<ul style="list-style-type: none"> <li></li> </ul>
	<ul style="list-style-type: none"> <li>Do gauge all connectors before first time use</li> </ul>	<ul style="list-style-type: none"> <li></li> </ul>
Mating/Demating	<ul style="list-style-type: none"> <li>Do align connectors carefully</li> </ul>	<ul style="list-style-type: none"> <li>Don't apply bending force to connection</li> </ul>
	<ul style="list-style-type: none"> <li>Do make preliminary connection lightly</li> </ul>	<ul style="list-style-type: none"> <li>Don't overtighten preliminary connection</li> </ul>
	<ul style="list-style-type: none"> <li>Do turn connector nut only to tighten</li> </ul>	<ul style="list-style-type: none"> <li>Don't twist or screw-in connectors</li> </ul>
	<ul style="list-style-type: none"> <li>Do use correct torque spanner for final connection</li> </ul>	<ul style="list-style-type: none"> <li>Don't overturn point of torque wrench</li> </ul>

Table 37 Measurement procedures



## 5. APPENDICES

CONTENTS	PAGE
5.1 ELECTROCHEMICAL POTENTIALS .....	136
5.2 MATERIAL PROPERTIES .....	138
5.2.1 Base Materials - Metals .....	138
5.2.2 Plating/Alloy Materials .....	139
5.2.3 Plastic/Rubber - Insulation, cable jacket and gasket material .....	140





## 5 APPENDICES

### 5.1 ELECTROCHEMICAL POTENTIALS

Difference of electrochemical potentials between some conductive materials (in mV)

ABSCISSA \ ORDINATE	Platinum	Gold/Carbon	Stainless steel	Titanium	Ag-Hg	Nickel	Copper alloy	Copper	Alu-bronze Brass 30% ZN	Silicon
Platinum	0	130	250	340	350	430	450	570	600	685
Gold/Carbon	130	0	110	210	220	300	320	440	470	535
Stainless steel	250	110	0	90	100	160	200	320	350	415
Titanium	340	210	90	0	10	90	110	230	260	325
Silver-Mercury	350	220	100	10	0	80	100	220	250	315
Nickel	430	300	180	90	80	0	20	140	170	235
Copper alloy	450	320	200	110	100	20	0	120	150	215
Copper	570	440	320	230	220	140	120	0	30	95
Alu-bronze Brass 30% ZN	600	470	350	260	250	170	150	30	0	65
Silicon	665	535	415	325	315	235	215	95	65	0
Brass 50% ZN	700	520	520	360	350	270	250	130	100	35
Bronze	770	640	550	430	420	340	320	200	170	105
Tin	800	670	590	460	450	370	350	230	200	135
Lead	840	710	680	500	490	410	390	270	240	175
Light alloy NSA 3001	940	810	690	600	590	510	490	370	340	275
Steels	1000	870	750	660	650	570	550	430	400	335
Aluminium A5	1090	960	840	750	740	650	640	520	490	425
Cadmium	1100	970	850	760	750	670	650	530	500	435
Chromium	1200	1070	950	860	850	770	750	630	600	535
Zinc	1400	1270	1150	1050	1050	970	950	830	800	735
Manganese	1470	1340	1220	1150	1120	1040	1020	900	870	805
Magnesium	1950	1620	1700	1610	1600	1520	1500	1380	1350	1285



-  the metal of the abscissa is attacked
-  the contact is practically neutral
-  the metal of the ordinate is attacked



Electrolysis: water with 2% salt

Difference of electrochemical potentials between some conductive materials (in mV)

Brass 50% ZN	Bronze	Tin	Lead	Light alloy NSA 3001	Steels	Aluminium A5	Cadmium	Chromium	Zinc	Manganese	Magnesium
700	770	800	840	940	1000	1090	1100	1200	1400	1470	1950
570	640	670	710	810	870	960	970	1070	1270	1340	1620
450	520	550	590	690	750	840	850	950	1150	1220	1700
360	430	460	500	600	680	750	760	860	1060	1150	1610
350	420	450	490	590	650	740	750	850	1050	1120	1600
270	340	370	410	510	570	650	670	770	970	1040	1520
250	320	350	390	490	530	640	650	750	950	1020	1500
130	200	230	270	370	430	520	530	630	830	900	1380
100	170	200	240	340	400	490	500	600	800	870	1350
35	105	135	175	275	335	425	435	535	735	805	1285
0	70	100	140	240	300	390	400	500	700	770	1250
70	0	30	70	170	230	320	330	435	630	700	1180
100	30	0	40	140	200	290	300	400	600	670	1150
140	70	40	0	100	160	250	260	300	560	630	1110
240	170	140	100	0	60	150	160	260	460	530	1010
300	230	200	160	60	0	90	150	200	400	470	950
390	320	290	250	150	90	0	100	110	310	380	860
400	330	300	260	160	150	100	0	100	300	370	850
500	430	400	360	260	200	110	100	0	200	270	750
700	630	600	560	460	400	310	300	200	0	70	550
770	700	670	630	530	470	380	370	270	70	0	480
1250	1180	1150	1110	1010	950	860	850	750	550	480	0

	the metal of the abscissa is attacked	}	Electrolysis: water with 2% salt
	the contact is practically neutral		
	the metal of the ordinate is attacked		

## 5.2 MATERIAL PROPERTIES

### 5.2.1 Base Materials - Metals

(Refer to Chapter 2 for description)

Properties	Beryllium Copper (CuBe)	Bronze	Brass (CuZn39Pb3)	Stainless steel (303/1.4305)	Anticorodal (AlMgSi1)
Density (g/cm <sup>3</sup> / lb/in <sup>3</sup> )	8.25	8.80	8.50	7.90	2.75
Melting at temperature °C / °F	865-980*	930-1060*	870-890	1420*	580-650
Electrical conductivity (% IACS 20°C / 68°F)	12*	11.5*	16	na	na
Electrical resistivity Q <sub>20</sub> (Ωmm <sup>2</sup> /m)	0.083	0.087	na	0.73	0.039
Thermal conductivity (W/m K)	na 115	na 80-85	na 120	15	170
Tensile strength (N/mm <sup>2</sup> / 10 <sup>3</sup> lbf/in <sup>2</sup> )	1270-1500*	350-820	380-590	500-750	310-370
Modulus of elasticity (N/mm <sup>2</sup> / 10 <sup>6</sup> lbf/in <sup>2</sup> )	130'000	118'000	96'000	200'000	70'000
Corrosion resistance **	+water, salt water	+water, salt water	0	+	++
Chemical resistance **	+oils; 0 acids, bases; -ammoniums	-to - with acids, bases & ammoniums	+	0	++
Machinability **	+	na	++	+	++

\* Owing to differences in purity in the case of elements and of composition in metals, the values can be considered only as approximations

\*\* The abilities of the materials (to be treated, shaped, etc.) are rated from ++ (excellent), + (good), 0 (fair), - (poor) to - - (very poor) compared with each other

## 5.2.2 Plating/Alloy Materials

Properties	Gold	Silver	Nickel	SUCOPLATE®
Density (g/cm <sup>3</sup> / lb/in <sup>3</sup> )	18.0*	10.5	8.9	8.20
Melting at temperature °C / °F	1063	960	1453*	na
Electrical resistivity $\rho_{20}$ ( $\Omega$ mm <sup>2</sup> /m)	0.022	0.015	0.09	na
Thermal conductivity (W/m °K)	310	410	60	na
Tensile strength at 20°C (N/mm <sup>2</sup> / 10 <sup>3</sup> lb/in <sup>2</sup> )	120	140	320	na
Elasticity module (N/mm <sup>2</sup> / 10 <sup>6</sup> lb/in <sup>2</sup> )	77'000	76'000	200'000	na
Corrosion resistance **	++	+	+	++
Machinability **	++	++	na	na
Chemical resistance **	+	+	+	++

\* Owing to differences in purity in the case of elements and of composition in metals, the values can be considered only as approximations

\*\* The abilities of the materials (to be treated, shaped, etc.) are rated from ++ (excellent), + (good), 0 (fair), - (poor) to - - (very poor) compared with each other

### 5.2.3 Plastic/Rubber - Insulation, cable jacket and gasket material

Properties	PE (PE-HD)	PTFE	PFA	FEP	PEEK	PPO
Density (g/cm <sup>3</sup> / lb/in <sup>3</sup> )	0.94	2.16*	2.15	2.16*	1.3	1.06
Temperature range °C / °F	-50 - +70	-200 - +260	-200 - +260	-100 - +200	-70 - +250	-30 - +140
Melting at temperature °C / °F	130	327	305	225	334	230
Dielectric constant at 1 MHz	2.3	2.1	2.1	2.1	3.3	2.7
Electrical resistivity (Ωcm)	> 1 × 10 <sup>17</sup>	> 1 × 10 <sup>18</sup>	> 1 × 10 <sup>17</sup>	> 1 × 10 <sup>18</sup>	5 × 10 <sup>16</sup>	> 1 × 10 <sup>16</sup>
Tensile strength (N/mm <sup>2</sup> / 10 <sup>3</sup> lb/in <sup>2</sup> )	27	27	26	20	92.0	60.0*
Modulus of elasticity (N/mm <sup>2</sup> / 10 <sup>6</sup> lb/in <sup>2</sup> )	790-1000	460	na	350	3900	2500
Water resistance (at 23°C / 73°F) **	++	++	+	++	-	+
Flammability **	HB-V-0	V-0	V-0	V-0	V-0	na
Chemical resistance **	+	++	++	++	++	na

\* Owing to differences in purity in the case of elements and of composition in metals, the values can be considered only as approximations

\*\* The abilities of the materials (to be treated, shaped, etc.) are rated from ++ (excellent), + (good), 0 (fair), - (poor) to - (very poor) compared with each other





## 6 REFERENCES

CONTENTS	PAGE
6.1 HUBER+SUHNER COMPANY PROFILE .....	143
6.2 GLOSSARY .....	144
6.3 BIBLIOGRAPHY .....	158
6.3.1 Chapter 1: Introduction to Basic RF Theory .....	158
6.3.2 Chapter 2: Materials and Plastics .....	158
6.3.3 Chapter 3: Connector Design .....	158
6.3.4 Chapter 4: Tests and Measurements .....	159



## 6 REFERENCES

### 6.1 HUBER+SUHNER SHORT COMPANY PROFILE



The HUBER+SUHNER Group is a leading global supplier of components and systems for electrical and optical connectivity. Our customers in Communications, Industrial and Transportation markets appreciate that we are specialists with detailed knowledge of practical applications. We offer technical expertise in radio and low frequency technology as well as fibre optics under one roof, thus providing a unique basis for continual innovation focused on the needs of our customers all over the world.

HUBER+SUHNER  
Switzerland

## 6.2 GLOSSARY

### A

<b>Accessories</b>	Mechanical devices, such as cable clamps, added to connector shells and other such hardware which is attachable to connectors to make up the total connector configuration.
<b>Admittance</b>	The measure of the ease with which an alternating current flows in a circuit. The reciprocal of impedance.
<b>Amplitude</b>	The magnitude of variation in a changing quantity from its zero value. The word requires modification - as with adjectives such as peak, maximum, rms, etc. - to designate the specific amplitude in question.
<b>Anneal</b>	Relief of mechanical stress through heat and gradual cooling. Annealing copper renders it less brittle.
<b>Attenuation (<math>\alpha</math>)</b>	The decrease of a signal with the distance in the direction of propagation. Attenuation may be expressed as the scalar ratio of the input power to the output power, or as the ratio of the input signal voltage to the output signal voltage.

### B

<b>Back Mounted</b>	When a connector is mounted from the inside of a panel or box with its mounting flanges inside the equipment.
<b>Backplane Panels</b>	An interconnection panel into which PC cards or other panels can be plugged. These panels come in a variety of designs ranging from a PC motherboard to individual connectors mounted in a metal frame. Panels lend themselves to automated wiring.
<b>Bandwidth</b>	The range of frequencies for which performance is kept within specified limits.
<b>Base Material</b>	Metal from which the connector, contact, or other piece part accessory is made and on which one or more metals or coatings may be deposited.
<b>Bayonet Coupling</b>	A quick coupling device for plug and receptacle connectors, accomplished by rotation of a cam operating device designed to bring the connector halves together.
<b>Bending Radius</b>	Minimum static: The minimum permissible radius for fixed installation of the cable. This radius is used in climatic tests. Minimum dynamic: The minimum permissible radius for flexible applications of the cable.

<b>BNC (Bayonet Navy Connector)</b>	Coaxial connector with bayonet coupling mechanism. Available in 50 Ohm and 75 Ohm versions. Frequency range DC - 4 GHz (50 Ohm) and 1 GHz (75 Ohm), respectively.
<b>BNO</b>	Connector with bayonet coupling mechanism suitable for shielded balanced twin cables.
<b>BNT</b>	Connector with bayonet coupling mechanism suitable for triaxial cables.
<b>Body</b>	Main, or largest, portion of a connector to which other portions are attached.
<b>Bonded Assembly</b>	A connector assembly in which the components are bonded together using an electrically appropriate adhesive in a sandwich like structure to provide sealing against moisture and other environment which weaken electrical insulating properties.
<b>Braid</b>	Woven wire used as shielding for insulated wires and cables. Also, a woven fibrous protective outer covering over a conductor or cable.
<b>Bulk Resistance</b>	The contact spring bulk resistance is dependent upon the conductivity of the base material and its geometry. Measured in m $\Omega$ (milliohms).
<b>Butted Contact</b>	When two conductors come together end-to-end, but do not overlap, with their axis in line.

## C

<b>Capacitance</b>	A measure of the coupling between signal conductors and from signal to ground. The electrostatic element that stores charge, influenced by material, design and conductor spacing.
<b>Cellular Polyethylene (SPE)</b>	Polyethylene with homogeneously distributed individual gas cells included (foam). Used primarily as a dielectric material and has an extremely low dielectric constant and power factor ( $\tan \delta$ ). Limited to operation below +70 °C.
<b>Conductivity</b>	A measure of the ability of a material to conduct electric current under a given electric field. Resistivity is the reciprocal of conductivity.
<b>Connector</b>	Used generally to describe all devices used to provide rapid connect/disconnect service for electrical cable and wire terminations.
<b>Contact Alignment</b>	Defines the overall radial play which contacts shall have within the insert cavity so as to permit self-alignment of mated contacts. Sometimes referred to as amount of contact float.

<b>Contact Engaging &amp; Separating Force</b>	Force needed to either engage or separate pins and socket contacts when they are in and out of connector inserts. Values are generally established for maximum and minimum forces. Performance acceptance levels vary by specification and/or customer requirements.
<b>Contact Plating</b>	Deposited metal applied to the basic contact metal to provide the required contact-resistance and/or wear-resistance.
<b>Contact Pressure</b>	Force which mating surfaces exert against one another.
<b>Contact Resistance</b>	Contact resistance is the electrical resistance arising from the contact force, geometry and surface properties of the contacting surfaces. Can be divided up into constriction (asperity spots) and film (contamination) resistance.
<b>Contact Retention</b>	Defines minimum axial load in either direction which a contact must withstand while remaining firmly fixed in its normal position within an insert.
<b>Contact Spacing</b>	The distance between the centres of contacts within an insert.
<b>Contact Spring</b>	The spring placed inside the socket-type contact to force the pin into a position of positive intimate contact. Depending on the application, various types are used, including leaf, cantilever, napkin ring, squirrel cage, hyperbolic and "Chinese finger" springs.
<b>Corrosion</b>	Corrosion products or films (thin layer) arise from an interaction between the non-noble portions of the contact part and the environment, e.g. through pores in noble platings. The contamination can cause unreliability, function failures and thereby high PIM. The spreading of contamination can be decreased by redundancy and wiping contacts. Wipe is a requirement to break through oxide films and displace contamination.
<b>Coverage</b>	A calculated percentage which defines the completeness with which a braid or shield covers the surface of the underlying component.
<b>Crimp</b>	Act of compressing (deforming) a connector ferrule around a cable in order to make an electrical connection.
<b>Crimping Dies</b>	A term used to identify the shaping tools that, when moved toward each other, produce a certain desirable shape to the barrel of the terminal or contact that has been placed between them. Crimping dies are often referred to as die sets or as die inserts.
<b>Crimping Termination</b>	Connection in which a metal sleeve is secured to a conductor by mechanically crimping the sleeve with pliers, presses or crimp dies.
<b>Cross Talk</b>	Signal interference between adjacent conductors caused by electromagnetic coupling.

**Cut-off Frequency ( $f_c$ )**

The frequency, above which other than the TEM mode may occur. The transmission characteristics of cables above their cutoff frequency may be unstable.

**D****dBm**

Relative measure of signal power where the reference 0 dBm is equal to one milliwatt. See also decibel.

**Decibel, dB**

A relative, dimensionless unit calculated as ten times the logarithm to the base 10 of a power ratio.

**Delay**

The signal delay caused by the connector capacitance or the propagation delay. The propagation delay can be reduced by shortening connector length.

**Delay Line**

A cable that delays electrical signals by a specified amount of time.

**Dielectric**

In a coaxial cable, the insulation between inner and outer conductor. It significantly influences the electrical characteristics such as impedance, capacitance, and velocity of propagation.

**Dielectric Constant (Permittivity)**

Basic electrical property of a material that describes its behaviour in an electric field. The dielectric constant of the dielectric is the most important design parameter for coaxial cables and determines dimensions, losses and propagation characteristics.

**Dielectric Loss**

In a coaxial cable, the losses caused by the transformation of electromagnetic energy into heat within the dielectric material.

**Dielectric Strength**

The voltage which an insulating material can withstand before breakdown occurs.

**DIN 7/16**

50  $\Omega$  coaxial connector with screw type coupling mechanism. Suitable for medium to high power applications. Frequency range DC - 7.5 GHz.

**Dip Solder Terminal**

The terminals on a connector which are inserted into holes in the PC board and then soldered in place.

**Direct Current (DC)**

An electric current which flows in only one direction.

## E

<b>Eccentricity</b>	A measure of a conductor's location with respect to the circular cross section of the insulation. Expressed as a percentage of centre displacement of one circle within the other.
<b>Elastomer</b>	Plastic material with firm shape which can be formed elastically.
<b>Electromagnetic Compatibility (EMC)</b>	EMC describes the ability of an electrical system to avoid electromagnetic interference with the environment.
<b>Elongation</b>	The fractional increase in length of a material under tension.
<b>ETFE (Ethylenetetrafluoroethylene)</b>	ETFE polymers are tough, high temperature resistant thermoplastics with excellent characteristics: non-ageing properties, chemical inertness, very good dielectric properties, weather resistance and low moisture absorption.
<b>Extrusion</b>	Method of forcing thermoplastic, rubber or elastomer material under elevated temperature and pressure through a die to apply an insulation or a jacket to a cable.

## F

<b>Farad</b>	Unit of capacitance. It indicates the charge per potential difference.
<b>Feed-through</b>	A connector or terminal block, usually having double-ended terminals which permit simple distribution and bussing of electrical circuits. Also used to describe a bushing in a wall or bulkhead separating compartments at different pressure levels, with terminations on both sides.
<b>FEP (Fluorinated Ethylene Propylene)</b>	FEP is similar to PTFE but is easier to process. Heat resistance and chemical inertness are outstanding.
<b>Ferrule</b>	A short tube. Used to make solderless connections to shielded or coaxial cable (e.g. as in crimping).
<b>Flame Resistance</b>	Property of a material to cease combustion once the heating flame is removed.
<b>Flange</b>	A projection extending from, or around the periphery of, a connector and provided with holes to permit mounting the connector to a panel, or to another mating connector half.

**Front Mounted**

A connector is front mounted when it is attached to the outside or mating side of a panel. A front mounted connector can only be installed or removed from the outside of the equipment.

**G****Groove**

Slot or cavity in a connector which bears directly on the cable. Also, the depression in a crimping die which holds the connector during crimping.

**Guide Pin**

A pin or rod extending beyond the mating face of a two-piece connector and designed to guide the closing or assembly of the connector to assure proper mating of contacts, and to prevent damage to these contacts caused by mismatching of the connector halves.

**H****Heat Shock**

Test to determine the stability of a material when exposed to a sudden high temperature change for a short period of time.

**Hermetic Seal**

Hermetically sealed connectors are usually multiple contact connectors where the contacts are bonded to the connector by glass or other materials and permits maximum leakage rate of gas through the connector of 1.0 micron ft./hr. at one atmosphere pressure for special applications.

**Hermaphroditic Connector**

A connector in which both mating members are exactly alike at their mating face. There are no male or female members, but provisions have been made to maintain correct polarity, hot lead protection, sealing and coupling.

**Hermaphroditic Contacts**

Contacts in which both mating elements are precisely alike at their mating face.

**Hermetic Seal**

Hermetically sealed connectors contain a glass-metal seal designed to reduce the leakage rate in special applications.

**I****IEC**

Abbreviation for International Electrotechnical Commission.

**IEC 331**

Horizontal flame test.

**IEC 332-1,2,3**

Vertical flame tests.



<b>IEEE</b>	Abbreviation for Institute of Electrical and Electronics Engineers.
<b>IM / PIM (Passive Intermodulation)</b>	The generation of new (and in the case of cable assemblies undesirable) signals (intermodulation products) at the non-linear characteristics of transmission elements.
<b>Impedance (characteristic, <math>Z_0</math>)</b>	Characteristic property of a transmission line describing the ratio between electric and magnetic fields.
<b>Inductance</b>	The property of a circuit or circuit element that opposes a change in current flow, thus causing current changes to lag behind voltage changes. It is measured in Henrys.
<b>Insert</b>	That part which holds the contacts in their proper arrangement and electrically insulates them from each other and from the shell.
<b>Insertion Loss</b>	The loss in load power due to the insertion of a component, connector or device at some point in a transmissions system. Generally expressed in decibels as the ratio of the power received at the load before insertion of the apparatus, to the power received at the load after insertion.
<b>Insulation</b>	A material having high resistance to the flow of electric current. Often called a dielectric in RF cable.
<b>Insulation Resistance</b>	The electrical resistance of the insulating material (determined under specified conditions) between any pair of contacts, conductors, or grounding device in various combinations.
<b>Interconnection</b>	Mechanically joining assemblies together to complete electrical circuits.
<b>Interface</b>	The two surfaces on the contact side of both halves of a multiple-contact connector which face each other when the connector is assembled.
<b>Interference</b>	An electrical or electromagnetic disturbance that causes undesirable response in electronic equipment.
<b>ISO</b>	Abbreviation for International Standards Organization.

## J

<b>Jacket</b>	An outer non-metallic protective cover applied over an insulated wire or cable.
---------------	---------------------------------------------------------------------------------

## L

- LAN** Abbreviation for Local Area Network. A data communications network confined to a limited geographic area (up to 6 miles or about 10 kilometers).
- Levels of Interconnection**
- Device to board or chassis.* The connection point between components (tubes, transistors, IC packages) and the PC board or chassis.
- Board to motherboard or backplane.* The connection point between PC boards or sub-circuit modules and the motherboard or a backplane board.
- Backplane wiring.* Connections between levels to each other and to other sub-circuits.
- Input/output.* Connections for power and signals into and out of a system. Connections may be between subassemblies within the same enclosure or between individual units. (See other explanations in chapter 3 "Connection Types").
- Low Loss Dielectric** An insulating material that has a relatively low dielectric loss, such as polyethylene or Teflon.
- Low Noise Cable** Cable specially constructed to avoid spurious electrical disturbances caused by mechanical movements.
- LSFH** Abbreviation for Low Smoke Free Halogene.

## M

- MCX (MICROAX)** Micro coaxial connector with snap-on coupling mechanism. Available in 50  $\Omega$  and 75  $\Omega$  versions. Frequency range DC - 6 GHz.
- Material Properties** Critical factors of connector design and performance are influenced by material properties:
- Mechanical:
- ◆ Modulus of elasticity
  - ◆ Dimensions and tolerances, *contact forces*
  - ◆ Yield strength/hardness
  - ◆ Treatment, *design stress*
  - ◆ Conductivity/Resistivity
  - ◆ Melting temperature
  - ◆ Stress relaxation
  - ◆ Corrosion resistance
  - ◆ Density
  - ◆ Availability

<b>MHV H4 (Miniature High Voltage)</b>	Coaxial connector with bayonet coupling mechanism. Working voltage 2.2 kV DC.
<b>Microstrip</b>	A type of transmission line configuration which consists of a conductor over a parallel ground plane, and separated by a dielectric.
<b>MIL</b>	Abbreviation for military (e.g. as in Military Standards in the USA).
<b>Mismatch, Connector Impedance</b>	Terminal or connector having a different impedance than that for which the circuit or cable is designed.
<b>MMBX</b>	MicroMiniature Board Connector with snap and slide design for board-to-board connections
<b>MMCX</b>	Miniature Microax connector with snap-on coupling mechanism. Available in 50 $\Omega$ and 75 $\Omega$ versions. Frequency range DC-6 GHz.
<b>Moisture Resistance</b>	The ability of a material to resist absorbing moisture from the air or when immersed in water.
<b>Motherboard</b>	A printed board used for interconnecting arrays of plug-in electronic modules.

## N

<b>N (Navy Connector)</b>	Coaxial connector with screw type coupling mechanism. Available in 50 Ohm and 75 Ohm versions. Frequency range DC - 18 GHz (50 Ohm) and 1 GHz (75 Ohm), respectively.
<b>Noise</b>	Random electrical signals, generated by circuit components or by natural disturbances.

## P

<b>PA (Polyamide/'Nylon')</b>	A resin used primarily as a jacket material having superior abrasion resistance, resistance to aliphatic solvents, but relatively high moisture absorption. Temperature -40° to 80 °C. Is inflammable.
<b>PE (Polyethylene)</b>	A resin compounded with various additives for use as an insulation, dielectric or jacket material. This material is light, tough, permanently flexible, has good resistance to chemicals, non-oxidizing acids and aromatic solvents, a low moisture absorption, and good tensile and tear strength. Temperature range -40° to 70 °C. In addition, it has a low dielectric constant and dissipation factor.

<b>Permeability (magnetic)</b>	The measure of how much better a material is than air as a path for magnetic lines of force. Air is assumed to have a permeability of 1.
<b>Permittivity Relative</b>	Synonym term for relative dielectric constant $\epsilon_r$ .
<b>PFA (Perfluoroalkoxy)</b>	Perfluoroalkoxy resins combine the processing ease of conventional thermoplastics with properties similar to PTFE.
<b>Phase Shift</b>	Change in phase of a voltage or current after passing through a circuit or cable.
<b>Phase Stability</b>	Variation of the electrical length of a cable as a function of - for example - the temperature or mechanical stressing such as bending or torsion.
<b>Pin Contact</b>	A male type contact, usually designed to mate with a socket or female contact. It is normally connected to the "dead" side of a circuit.
<b>Plating Porosity</b>	Porosity is small holes in the plating, which depends on the plating thickness and parameters as well as substrate defects. The pores may be sites at which corrosion can occur.
<b>Plating Process</b>	Depositing material on another surface. Common processes are electroplating, electroless plating, hot dipping and cladding. Also called coating process.
<b>Plug</b>	The part of the two mating halves of a connector which is free to move then not fastened to the other mating half. The plug is usually thought of as the male portion of the connector. This is not always the case. The plug may have female contacts if it is the "free to move" member.
<b>PP (Polypropylene)</b>	A polymer similar to PE, but stiffer and harder.
<b>Press-Fit Contact</b>	An electrical contact which can be pressed into a hole in an insulator, printed board (with or without plated-through holes), or a metal plate.
<b>Printed Circuit Board (PCB)</b>	The general term of completely processed printed circuit or printed wiring configurations. It includes single, double, and multilayer boards, both rigid and flexible.
<b>PTFE (Polytetrafluoroethylene)</b>	The thermally most stable and chemically most resistant carbonaceous compound. It is unaffected by sunlight, moisture, and virtually all chemicals. Temperature range is -200°C to +260 °C. Electrical properties are very constant over temperature and a wide range of frequencies.
<b>Pull Out</b>	Force needed to separate a cable from a connector by pulling them apart.

**PUR (Polyurethane)** Thermoplastic polymer used for cables as an extruded jacket. Exhibits extreme toughness and abrasion resistance, flexible to below  $-50^{\circ}\text{C}$ .

**PVC (Polyvinylchloride)** Plasticised vinyl resin used as an insulation or jacket material which exhibits the property of high electrical resistivity, good dielectric strength, excellent mechanical toughness, superior resistance against oxygen, ozone, most common acids, alkalis and chemicals. Flame-resistance, oil-resistance and the temperature range ( $-55^{\circ}$  to  $105^{\circ}\text{C}$ ) are depending on the compound.

## Q

**QLA** 50  $\Omega$  subminiature Connector with quick latch coupling mechanism.

**Quick-Connect** A test connector featuring a special threaded coupling nut which mates after a three-quarter turn.

**Quick.Lock** A snap-on connector interface design with retractable lock-nut, providing a fast connect/disconnect feature.

## R

**Rack and Panel Connectors** A rack and panel connector is one which connects the inside back end of the cabinet (rack) with the drawer containing the equipment when it is fully inserted.

**RADOX<sup>®</sup>** Trademark of HUBER+SUHNER for crosslinked, flame retardant, heat resistant and halogenfree insulation and jacket materials.

**Range** Number of sizes of connectors or cables of a particular type.

**Receptacle** Usually the fixed or stationary half of a two-piece multiple contact connector. Also the connector half usually mounted on a panel and containing socket contacts.

**Reflection** See VSWR.

**Reflection Loss** The part of a signal which is lost due to reflection of power at a line discontinuity.

**RG/U** Symbol used to designate coaxial cables that are made to Government Specification (e.g., RG58/U; in this designation the "R" means radio frequency, the "G" means Government, the "58" is the number assigned to the government approval, and the "U" means it is an universal specification).

## S

<b>Screening Effectiveness</b>	Specifies by how much the field strength issuing from a transmission line through the screen is lower than inside the line.
<b>Self-Align</b>	Design of two mating parts so that they will engage in the proper relative position.
<b>Semi-rigid</b>	A coaxial cable containing a flexible inner core and a relatively inflexible sheathing.
<b>Shield</b>	(1) A conducting housing or screen that substantially reduces the effect of electric or magnetic fields on one side thereof, upon devices or circuits on the other side. Cable shields may be solid, braided, or taped (longitudinally or spirally). (2) In cables, a metallic layer placed around a conductor or group of conductors to prevent electrostatic or electromagnetic interference between the enclosed wires and external fields.
<b>Shielding</b>	The metal sleeving surrounding one or more of the conductors, in a wire circuit to prevent interference, interaction or current leakage.
<b>Shock (mechanical)</b>	(1) An abrupt impact applied to a stationary object. (2) An abrupt or non-periodic change in position, characterized by suddenness, and by the development of substantial internal forces.
<b>SHV (Safe High Voltage)</b>	Coaxial connector with bayonet coupling mechanism. Working voltage 5 kV DC.
<b>Skin Effect</b>	The phenomenon wherein the depth of penetration of electric currents into a conductor decreases as the frequency of the current increases.
<b>SMA (Subminiature A)</b>	50 $\Omega$ - Subminiature coaxial connector with screw type coupling mechanism. Frequency range DC - 18 GHz.
<b>SMB (Subminiature B)</b>	Subminiature coaxial connector with snap-on coupling mechanism. Frequency range DC - 4 GHz.
<b>SMC (Subminiature C)</b>	Subminiature coaxial connector with screw type coupling mechanism. Frequency range DC - 10 GHz.
<b>SMPX</b>	Microminiature precision connector for a frequency range up to 40 GHz.

<b>SMS</b>	Subminiature coaxial connector with slide-on coupling mechanism. Frequency range DC - 4 GHz.
<b>Snap-on</b>	Used to describe the easy removal or assembly of one part to another. A connector containing socket contacts into which a plug connector having male contacts is inserted.
<b>Solder Process</b>	A connector mechanically and electrically connects to a PCB or other substrate via a solder process. Rapid heating and cooling is recommendable, as flux de-grade, oxidation, metallurgical changes and intermetallic compound formation will occur due to prolonged heating. Various types of solder processes in order of increased process temperatures: manual soldering, wave solder, intrusive reflow, vapor phase reflow and Infra-Red (IR) reflow.
<b>Spring-Finger Action</b>	Design of a contact, as used in a printed circuit connector or a socket contact, permitting easy, stress-free spring action to provide contact pressure and/or retention.
<b>Stripline</b>	A type of transmission line configuration which consists of a single narrow conductor parallel and equidistant to two parallel ground planes.
<b>SUCOPLATE®</b>	A plating material made out of a combination of copper, tin and zinc. Good corrosion and abrasion resistance. Non magnetic. Registered mark of HUBER+SUHNER.

## T

<b>Thermal Shock</b>	The effect of heat or cold applied at such a rate that non-uniform thermal expansion or contraction occurs within a given material or combination materials. The effect can cause inserts and other insulation materials to pull away from metal parts.
<b>TNC (Threaded Navy Connector)</b>	Coaxial connector with screw type coupling mechanism. Available in 50 Ohm and 75 Ohm versions. Frequency range DC - 11 GHz (50 Ohm) and DC - 1 GHz (75 Ohm), respectively.
<b>Transmission Line</b>	A signal-carrying circuit composed of conductors and dielectric material with controlled electrical characteristics used for the transmission of high-frequency of narrow-pulse type signals.
<b>Transmission Loss</b>	The decrease or loss in power during transmission of energy from one point to another. Usually expressed in decibels.

**Triaxial Cable** A cable consisting of one centre conductor and two outer concentric conductors (with an insulating layer separating them). Notable for increased shielding efficiency.

**Twinaxial Cable** Two conductors that are insulated from one another, twisted together and surrounded by a common shield.

## U

**UHF** Coaxial connector with screw type coupling mechanism. Non-defined impedance. Frequency range DC - 200 MHz.

## V

**Velocity of Propagation** The speed of an electrical signal down a length of cable compared to speed in free space expressed as a percentage.

**VSWR** Abbreviation for Voltage Standing Wave Ratio. The ratio of the maximum to minimum voltage set up along a transmission by reflections.

## W

**Wave Length** The distance, measured in the direction of propagation, of a repetitive electrical pulse or waveform between two successive points that are characterised by the same phase of vibration.

**Wiping Action** The action which occurs when contacts are mated with a sliding action. Wiping has the effect of removing small amounts of contamination from the contact surfaces, thus establishing better conductivity.

**Wire Wrapping** Method of connecting a solid wire to a square, rectangular or V-shaped terminal by tightly wrapping or winding it with a special automatic or hand operated tool.



## 6.3 BIBLIOGRAPHY

### 6.3.1 Chapter 1: Introduction to Basic RF Theory

1. "Einführung in die Mikrowellen-Technik und Bauteile" by A. Bosshard / G.Kühne / I. Falk, HUBER+SUHNER AG, 9100 Herisau, Switzerland, 1985/1991
2. "Begriffe der elektrischen Übertragungstechnik" by P.R. Schmid, Manager of the Cable Department, Interconnections Division, HUBER+SUHNER AG, 9100 Herisau, Switzerland, 1993
3. "Approaches to Solving the Problem of Intermodulation Involving Passive Components" by U. Hügel and S. Frei, R&D Department, Interconnections Division, HUBER+SUHNER AG, 9100 Herisau, Switzerland, 1993

### 6.3.2 Chapter 2: Materials and Plastics

1. "Material Selector 1988" by Materials Engineering, P.O.Box 91368, Cleveland, Ohio 44101, USA. Published by Penton Publishings, Inc., 1988
2. "Connector Engineering Design Guide" by Brush Wellman, Inc., World Headquarters, 17876 St. Clair Avenue, Cleveland, Ohio 44110, USA, 1995
3. "Die Kunststoffe und ihre Eigenschaften" by Hans Domininghaus. Published by VDI Verlag, Germany. 2nd Edition, 1986, ISBN 3-18-400738-3
4. "Halbfabrikate aus Kunststoffen - Werkstoff-Eigenschaften und Anwendungen" by Angst+Pfister AG, Zurich, Switzerland, 1994
5. "CRC Handbook of Chemistry and Physics" by David R. Lide. Published by CRC Press, Inc., USA. 75th Edition, 1994

### 6.3.3 Chapter 3: Connector Design

1. "Connectors and Interconnections Handbook", Volume 1-4, Basic Technology by The Electronic Connector Study Group, Inc., USA, 1979
2. "Einführung in die Mikrowellen-Technik und Bauteile" by A. Bosshard / G.Kühne / I. Falk, HUBER+SUHNER AG, 9100 Herisau, Switzerland, 1985/1991

### 6.3.4 Chapter 4: Tests and Measurements

1. "Low Level Measurements - for Effective Low Current, Low Voltage and High Impedance Measurements" by Keitley Instruments, Inc., USA. 3rd Edition, 1984
2. "Handbook of Coaxial Microwave Measurements" by Gilbert Engineering, USA. Published by Genrad, Inc., 1968
3. "Modern Microwave Measurements and Techniques" by Thomas S. Laverghetta, USA. 2nd Edition, 1988. ISBN 0-89006-307
4. "Microwave Datamate" by Marconi Instruments Ltd., UK-New Jersey 07401, 1987
5. "The Connector Interface and its Effect on Calibration Accuracy" by Bill Oldfield, Wiltron Company, Morgan Hill, CA, USA. Published by Microwave Journal, March 1996
6. "Approaches to Solving the Problem of Intermodulation Involving Passive Components" by U. Hügel and S. Frei, R&D Department, Interconnections Division, HUBER+SUHNER AG, 9100 Herisau, Switzerland, 1993
7. "Application Note 326 - Coaxial Systems; Principles of microwave connector care (for higher reliability and better measurements)" by Hewlett Packard, USA.



# 7 INDEX

## A

	PAGE
abrasion resistant	51
acids	46
active intermodulation	37
adhesion	49
alloy base metal	46
alloys	45
aluminium	47
ammonia	46
anti-adhesive	53
assembly instructions	84
assembly tools and instructions	83
attachments	77
attachment of cable inner conductor	78
attachment techniques	77
attachment to the print board	82
attenuation	31
attenuation loss	12, 32
attenuation loss components	32
axial	69

## B

band designations	10
barb(s)	71
base materials	45
bayonet coupling	75
beryllium copper alloy	46
brass	47
bronze	47
bulk resistance	42, 43
bulkhead mounted	81
butted contact	65, 67, 68

## C

cable capacitance	16, 17
cable connectors	69
cable inductance	16, 17
cable retention force	61
calibrated	84
calibrated crimp dies	80
calibration	114
calibration sets	84
caoutchouc	54
capacitive	9
capture mechanism	69
centre contact	65

## PAGE

characteristic impedance	16, 33
chassis	64
clamping	79, 80
cleaning	133
climatic changes	61
climatic classes	62
coaxial connector components	64
cold welding	44, 79
compliant pin	42
conductivity of the inner conductor	32
conductivity of the outer conductor	32
connection types	63
connector body	66
connector pairs	109
contact area	41
contact captivation	61, 69
contact captivation design	71
contact force	42, 43
contact geometry	42, 43
contact materials and plastics	41
contact pressure	66
contact resistance	42, 43, 60
contaminant	42
contributions to intermodulation products	38
copper	46
copper conductors:	36
copper-tin-alloy	47
corrosion	62
corrosion resistance	42
coupling mechanisms	75
coupling nut	75
coupling nut torque	61
crimp	44
crimp ferrule	79
crimped	78
crimping	42, 79
crossed knurls	71
current	14
current capacity	42, 44
current density	35
cut-off frequency	12, 18

## D

device under test	112
dielectric	67

	<b>PAGE</b>		<b>PAGE</b>
dielectric bead	68		
dielectric constant	67	<b>G</b>	
dielectric losses	12	gaskets	54
dielectric material	21	gating	123
diffusion	49	gauging (measuring)	133
diffusion barrier	50	gold	49
dimple-captivation	71		
discoloration	52	<b>H</b>	
discontinuities	22,30,31	halogen free plastics	52
discontinuity	23,24	handling and storage	133
disengagement force	61	heavy-duty plastic	53
displacements	69	high frequency	9
dos and don'ts	133	high machinability	47
ductility	46	homogeneity	64
durability	61		
DUT	112	<b>I</b>	
<b>E</b>		ideal line	25, 26, 27
edge-mount	83	ideal performance	59
EHF	10	ideal vs real	59
electric	12	impedance	12, 15, 16, 17, 18, 60
electric field	13	incident voltages	14
electrical conductivity	49	inductances	15
electrical performance	59	inductive pin gaps	115
electrochemical potential	51	inductive resistances	9
electrolytically deposited metals	48	inflexible	54
electromagnetic field	12	inner conductor	65
engagement force	61	inner conductor captivation	72
environmental performance	61	input-reflection coefficient	111, 112
epoxy	71	insertion and extraction forces	42, 43
error contributors	114	insertion loss	60, 113, 118
external connections	63	insulation resistance	42, 44, 60
external element	77	insulator	67
<b>F</b>		insulator captivation	73
feeder transmission line	127	intermodulation (pim) products	37
female	113	intermodulation products	37
field strength	13, 17	internal	63
flame resistance	52	internally stepped sections	71
forward-transmission coefficient	111, 112	<b>J</b>	
fourier transformation	123	jack	113
four-parameter network	110	<b>K</b>	
frequency	19, 20, 60	kinking	117
frequency domain	124	<b>L</b>	
frequency ranges	9	LF	10
frontal contact	66	longitudinal	69
function and performance	59		

	<b>PAGE</b>		<b>PAGE</b>
lossless	16	passive intermodulation products	126
lossless line	16	PCB	63
low-intermodulation design	127	PE	52
low-loss	16	PEEK	53
lubricant	49	permeability	51
<b>M</b>		PFA	53
magnetic field	12, 13	phase alignment	111
male	113	phase shift	23, 24
malleable	50	pico-seconds	123
matched line	24	piece-part	47, 65
mated pair	75	PIM behaviour	132
material resistivities	33	pin depth	114
materials	41	plating	48
max. frequency of the coaxial line	60	plating flash	46
measurement theory and methods	109	plug	113
measurements of reflections and transmission	115	plugged	79
mechanical performance	60	polyethylene (PE)	52
MF	10	polyphenylene oxide (PPO)	54
microstripline	69	polytetrafluorethylene (PTFE)	53
mismatch	24	poor machinability	47
mismatched line	24	porosity	49
mismatches	114, 123	power ratio to carriers	127
mobile communication	126, 127	power transmitters	126
moisture	62	PPO	54
<b>N</b>		practical measurements	113
nickel	50	precision adaptors	114
nickel free	51	precision interface design	114
non-linearity	126	pressed-in	71
non-magnetic	51	press-fit	44
<b>O</b>		pressing	82
one and two-port network methods	109	print socket	83
one-port network	112, 123	protective coating	48
open circuit	25, 27	PTFE	53
open-short-load	115	<b>Q</b>	
operating frequency	60	quality	77, 83
OSL	115	<b>R</b>	
outer conductor	66	radially bonded	65
outer conductor captivation	73	radially contacted	66
outer contact	66	reactances	15
output-reflection coefficient	111, 112	receiver sensitivity	128
overlap (conical)	68	reference level	117
overlap (cylindrical)	68	reflection coefficient	25, 26, 112, 113
passive intermodulation	37	reflection factor	115
passive intermodulation level (PIM)	113, 126	reliability	42, 77
		repeatability	49, 84
		repeatable attachment	84

	<b>PAGE</b>		<b>PAGE</b>
requirements	46	surface smoothness	41, 42
resilient contacts	47	surroundings	61
resistance	9, 15	swagings	71
retaining direction	72	<b>T</b>	
return loss RL	26, 113, 115,	TEM	12
reverse-transmission coefficient	111, 112	temperature	42
RF	12	temperature range	62
RF leakage	60	tensile strength	46
ring with cams	71	terminations	114
rotational movements	69	test set-up	114
<b>S</b>		tests and measurements	109
salt water	62	thermostability	53
screw-snap-connection	75	thread	75
SHF	10	threaded connection	75
shielding	33	through-connection	117
short	23, 25	time domain	123
short circuit	22, 27	transmission coefficient	116
shoulder or step	71	two-port network	109
signal ratios	38	<b>U</b>	
signal-to-noise ratio	129	UHF	10
silicone rubber	54	upper frequency	12
silver	50	<b>V</b>	
skin depth	35, 36	vector network analyser	109
skin effect	12, 35	velocity of light	16, 20
slide-on coupling	77	velocity of propagation	12, 20, 21
slotted (resilient) contact	67	VHF	10
snap-on coupling	76	visual inspection	133
solder flux	78	VLF	10
solderability	44	VSWR	60, 113, 115
soldered	78	<b>W</b>	
soldering	42, 78, 79, 80, 82	water absorption	52
s-parameters (scattering parameters)	110	wavelength	19, 20, 111
spring characteristics	46	wear deterioration	46
spring properties	44	wear resistance	49
stainless steel	47	wear-through	49
straight knurls	71	worst case	115
stress relaxation	46	<b>Z</b>	
stripline	69	zero span	130
SUCOPLATE	51		
SUCOPRO	51		
surface hardness	42		
surface oxidation	48		
surface-mount	83		

HUBER+SUHNER is certified according to  
ISO 9001, ISO 14001, ISO/TS 16949 and IRIS.

**WAIVER**

It is exclusively in written agreements that we provide our customers with warrants and representations as to the technical specifications and/or the fitness for any particular purpose. The facts and figures contained herein are carefully compiled to the best of our knowledge, but they are intended for general informational purposes only.

HUBER+SUHNER AG  
Radio Frequency Division  
9100 Herisau/Switzerland  
Tel. +41 (71) 353 41 11  
Fax +41 (71) 353 44 44



[hubersuhner.com](http://hubersuhner.com)