



Defense

Reliable, high performance solutions

Edition 2021

Reliable, high performance solutions

The background is a deep blue gradient filled with a dense field of small, bright white and light blue dots, resembling a starry night sky or a data visualization. In the center, there is a large, glowing circular area with a bright cyan core that fades into a darker blue outer ring.

Content

Applications	4
Airborne	4
Missile	6
Radar	8
Naval	10
Command and control	12
Vehicles	14
Tactical equipment/submodules	16
Lab testing	18
Radio frequency solutions	20
Microwave cable assemblies	20
Minibend series	50
32071 – high power cable assemblies	62
Eacon – field terminated microwave assembly	66
High flex cables	72
Multiport	74
RF cables	76
LSFH cables	82
RF connectors and adaptors	84
Board-to-board connectors	86
Phase shifters	108
HEMP and lightning protection	110
Antennas	118
Wires and cables	122
Fiber optics solutions	130
All-optical switches	138
RF-over-Fiber	144
System solutions	158
RF cable selection guide	160
Further documentation	162

Your partner for system solutions

HUBER+SUHNER is a leading international manufacturer and supplier of components and systems for electrical and optical connectivity. HUBER+SUHNER unites technical and manufacturing expertise in radio frequency, fiber optics and low frequency technologies under one roof and offers a highquality product range for the defense market.

Airborne



With extreme environmental changes and load factors up to 10 g, electrical and electronic systems for aircraft require cables and connectors of superior quality. HUBER+SUHNER has many years of experience in the development, production and qualification of cables, connectors and cable systems for airborne applications. Our solutions are used in many systems around the globe and have proven to be reliable and meet the toughest requirements.

Applications

- Fighter jets
- Helicopters
- UAV
- High altitude airship/aircraft

Requirements

- Ultra-low weight and ruggedized solutions
- Small form factor, minimal bend radius (bend-to-the end)

Heritage

EUROFIGHTER, MIG platforms, AWACS, C130, E2C-ESM, EA6B, F15, F16, F18, F22, F35, IDECM/ALE-SS, JSTARS, Predator, Tornado, Global Hawk, EP-3, HH-60G, AN/APR-39, NH-90, A400M

Microwave cable assemblies

HUBER+SUHNER flexible microwave cable assemblies offer superior electrical and mechanical performance for static and dynamic applications. These assemblies provide optimal performance up to 90 GHz, where stringent electrical requirements are important.

- SUCOFLEX
- Minibend
- Eacon
- Everflex



Connectors

HUBER+SUHNER is a leading global provider of radio frequency connectors for the transmission of analog and digital signals. In addition to a broad selection of standard connectors for a wide range of different applications, we also develop and manufacture customer-specific solutions.

- BMA
- SMPM-T



VITA 67

Our VITA 67 is the first high performance true 65 GHz SMPM cable assembly in the market. Thanks to the solderless Minibend bend-to-the-end technology tightest bending radius (0.06"/1.5 mm) is applicable immediately behind the connector. The snap-in captivation method guarantees an easy and quick installation without any tools or loose parts.



RF-over-Fiber

High density RF connectivity and light-weighting are key elements that are optimally addressed by RF-over-Fiber. With system interconnects often requiring dozens of RF connections between various sensors, antennas and other systems, the HUBER+SUHNER RF-over-Fiber products provide flexibility by ensuring that the solution is easily scalable.

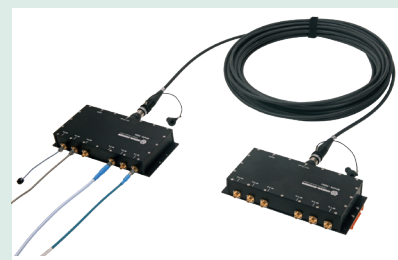

Missile



The constant motion of a seeker head, coupled with the extreme acceleration and environmental influences, requires the highest performing microwave cable assemblies. HUBER+SUHNER has a unique cable assembly portfolio proven to repeatedly withstand 1000 000 flexure cycles with minimal degradation. Additionally, Minibend's bend-to-the-end technology offers great flexibility in the tightest space restrictions.

Applications

- Missile-mounted radars, antennas
- Test benches

Requirements

- Excellent flex properties (up to 1000 000 cycles)
- Low resistance to movement
- Small form factor
- High temperature environment

Heritage

AEGIS, Patriot, Erint/Pac 3, Sea Sparrow, Hawk, ESSM, CJR, CREW, RAM, AIM9M, AMRAAM, HARM, ARROW, THAAD, JLENS, CAMM, Meteor

Microwave cable assemblies

HUBER+SUHNER flexible microwave cable assemblies offer superior electrical and mechanical performance for static and dynamic applications. These assemblies provide optimal performance up to 90 GHz, where stringent electrical requirements are important.

- Minibend
- SUCOFLEX

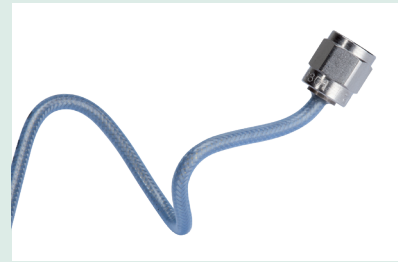

High flex cables

HUBER+SUHNER is a leading global provider of radio frequency connectors for the transmission of analog and digital signals. In addition to a broad selection of standard connectors for a wide range of different applications, we also develop and manufacture customer-specific solutions.

- Everflex
- Multiflex_53



Connectors

HUBER+SUHNER is a leading global provider of radio frequency connectors for the transmission of analog and digital signals. In addition to a broad selection of standard connectors for a wide range of applications, customer-specific solutions can also be developed and manufactured.

- SMPM-T
- SMP
- Self-locking connectors

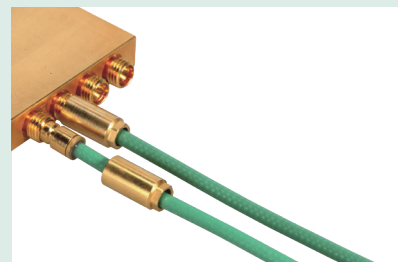

Power cables

The characteristics of our power cables make them ideal for use in a wide range of applications, where space is at a premium and in harsh environments with high moisture, high temperatures, rapid changes of humidity and where protection against fluids is mandatory.



Radar



With few exceptions, today's generation of radars employ a phased array or active electronically steered array (AESA) architecture to improve reliability and accuracy, and to allow tracking of multiple targets. HUBER+SUHNER offers a wide range of low loss and phase stable microwave cable assemblies to meet the requirements of today's systems. Miniaturization is a key driver for higher integration and density. Our board-to-board solutions cope with the largest mechanical misalignment and are complemented by our Minibend products. The bend-to-the-end technology enables high integration densities without compromising performance and reliability.

Applications

- Radars
- T/R modules

Requirements

- Low loss, phase stable cable assemblies
- Small form factor, minimal bend radius (bend-to-the-end)

Heritage

3DLERR, GM radar

Microwave cable assemblies

HUBER+SUHNER flexible microwave cable assemblies offer superior electrical and mechanical performance for static and dynamic applications. These assemblies provide optimal performance up to 90 GHz, where stringent electrical requirements are important.

- Minibend
- SUCOFLEX
- Phase invariant cable assemblies (Minibend CT, < 300 ppm change over temp)



High flex cables

HUBER+SUHNER is a leading global provider of radio frequency connectors for the transmission of analog and digital signals. In addition to a broad selection of standard connectors for a wide range of applications, customer-specific solutions can also be developed and manufactured.

- MBX
- MMBX
- SMP



Lightning protectors

HUBER+SUHNER lightning protection products are designed to meet the stringent requirements of the defense and security markets. Both quarter-wave and wideband gas discharge tube (GDT) versions are available for applications up to 18 GHz. An extensive high-voltage impulse laboratory is also available for customer specific design verification.

- 3400 series quarter wave protectors
- Semper self-extinguishing gas capsule protectors



Fiber optic assemblies

Fiber optic cables support the mobility of the application by reducing both the cable footprint and the overall weight of the solution. This dramatically simplifies and speeds up the installation and maintenance of the system. The use of HUBER+SUHNER's RADOX® technology ensures superior performance in harsh environments. The Q-ODC-12 connects up to 12 fibers in a single mating step, providing both increased flexibility and fast installation.



RF-over-Fiber

With customers requiring that new solutions and systems combine various technologies, HUBER+SUHNER is able to provide our customers with end-to-end-solutions. The RF-over-Fiber series enables the use of radio frequency and fiber optics in a single system. Application support is available.

- RF-over-Fiber
- LAN-over-Fiber
- GPS-over-Fiber (L1 and L2)

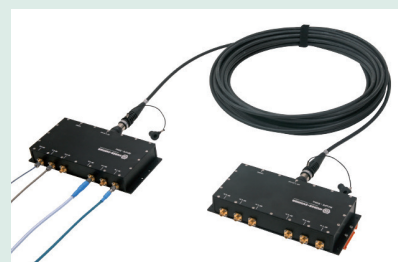

Naval



HUBER+SUHNER connectors, cable assemblies and protection devices are designed to withstand the harsh environments encountered aboard a ship or submarine. Our designs meet the military requirements for salt fog testing and we can custom design solutions using o-rings and/or glass seals for the most extreme conditions. HUBER+SUHNER uses RADOX® and LSFH (low smoke free of halogen) materials to address the challenging flammability and smoke density requirements inherent in naval applications.

Applications

- Submarine
- Ship

Requirements

- LSFH – low smoke free of halogen
- Corrosion protected and highly dust- and waterproof solutions
- Field mountable with smallest feedthrough

Heritage

LAMPSS MKIII, Phalanx, Sidekick, SPY3, Sea Hawk, Zumwalt, NMT, SSEE

LSFH cables

HUBER+SUHNER's broad range of low smoke free of halogen (LSFH) cables provide the lowest attenuation, high flexibility and optimal shielding for applications up to 18 GHz. Our RADOX® and LSFH compounds were developed to avoid hazardous fumes in the event of a fire.

- Spuma FR
- Enviroflex
- SUCOFLEX



Connectors

In addition to our standard connector portfolio, HUBER+SUHNER can also offer stainless steel configurations to reduce the risk of corrosion under the extreme conditions of naval applications. Additional protection by adding rubber boots or o-rings is also possible, depending upon the interface.



Lightning protectors/high power limiters

Our high power RF limiter is a multi-stage component, designed to protect the first stage of shipboard equipment by limiting harmful RF power the front-end receiver will see, as well as providing protection from lightning and NEMP pulses. In addition, we offer a broad range of lightning and EMP protection devices to protect sensitive equipment in exposed locations.



Fiber optic assemblies

HUBER+SUHNER's Q-ODC-12/RADOX® cable assemblies provide a simple and elegant high density interconnect solution for shipborne communication networks. The RADOX® cross-linked jacketing material provides an extended temperature range, resistance against oil/chemicals and UV radiation, and is low-smoke free of halogen, to minimize hazardous fume ingestion in the event of fire.



RF-over-Fiber

Naval applications have requirements for intra-vessel communication and networking systems, as well as mission-relevant systems. The density of connectivity and the distance between the RF equipment and the receiver systems, make the RF-over-Fiber Series ideal for naval applications. Application support is available.

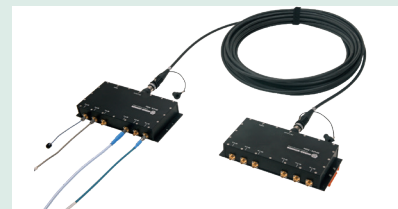

Power and data cables

The RADOX® MFH-S cable portfolio meets the most challenging requirements in naval applications for both signal and power transmission. The high abrasion and vibration resistance and small bending radius are key assets for the typically congested environments on ships and submarines. The RADOX® material was developed to avoid hazardous fumes in the event of a fire.



Command and control



Command and control centers are typically located within mobile shelters or bunker infrastructures and must comply with MIL-STD-188 (or equivalent) shielding specifications. Every point of entry into this type of Faraday cage has a negative impact on the screening effectiveness of the complete system.

HUBER+SUHNER EMP protector designs (coaxial and data line) offer bulkhead feedthrough solutions that guarantee high, long-term screening effectiveness and provide the lowest transfer impedance to protect any sensitive equipment. By using fiber optic cables within a traditional RF or datalink (Ethernet) system, it is possible to position the shelters further from the antennas without sacrificing loss or signal data integrity. Our RF-over-Fiber system provides a significant advantage in terms of safety, overall screening effectiveness, and ease of installation.

In addition to the RF-over-Fiber solution, HUBER+SUHNER can provide all additional connectivity solutions within a shelter.

Applications

- Mobile shelters
- Bunkers

Requirements

- High, longterm screening effectiveness
- Immunity against EMI, EMP

Microwave cable assemblies

HUBER+SUHNER flexible microwave cable assemblies offer superior electrical and mechanical performance for static and dynamic applications. These assemblies provide optimal performance up to 18 GHz, where stringent electrical requirements are important.

- Eacon
- Enviroflex
- Spuma



Lightning protectors

HUBER+SUHNER lightning protection products are designed to meet the stringent requirements of the defense and security markets. Both quarter-wave and wideband gas discharge tube (GDT) versions are available for applications up to 18 GHz. An extensive high-voltage impulse laboratory is also available for customer specific design verification.

- 3400 series quarter wave protectors
- Semper self-extinguishing gas capsule protectors



Fiber optic assemblies

The use of FO cables minimizes the cable footprint and the overall weight of the solution, which dramatically simplifies and reduces the time required for both installation and maintenance of the system. Fiber optic technology offers immunity to EMI, EMP and RFI, critical in command and control environments. HUBER+SUHNER's RADOX® technology ensures superior performance in harsh environments.



RF-over-Fiber

Connectivity and the safety of the control center are key in an antenna remoting system. RF-over-Fiber systems are ideal in command and control centers, since they take advantage of all the benefits – flexibility in installation, proximity of the shelter to the antennas, the harsh environment fiber optic connectors, and the immunity to EMI, EMP and RFI.

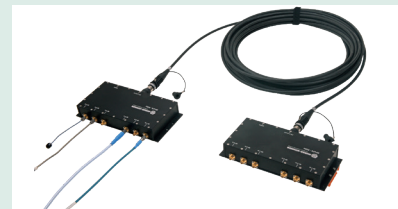

Antennas

HUBER+SUHNER provides broadband antenna solutions for both tactical communication, electronic countermeasure (ECM) and navigational aid. The ruggedized designs ensure system reliability even under the harshest environments, whether mounted on vehicles, man packs or in fixed installations on shelters, masts or containers.



Databus cables

HUBER+SUHNER databus cables provide reliable solutions for use in high-temperature applications and harsh environmental conditions. Extended temperature range, resistance against UV (sun), oil and other aggressive chemicals are mandatory performance parameters for a reliable communication link.

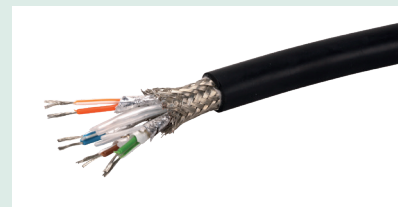

Vehicle



Combat vehicles incorporate a wide variety of land based communication equipment operating between 1 MHz and 20 GHz, including navigational aids and jammers, as well as satellite communication hardware. The vast variety of equipment establishes new standards for channel-to-channel isolation requirements, to avoid interferences and to guarantee trouble-free operation of the equipment. HUBER+SUHNER solutions are distinguished by their high shielding performance, robustness and ease of use in the field. Additionally, our EMP protectors are used in many mobile platforms to harden the equipment against LEMP and NEMP, and to provide protection from lightning strikes to the equipment.

Applications

- Jamming
- Communication
- Navigation

Requirements

- Wide frequency range for equipment, multiple protection devices
- Field-mountable with minimal points of entry
- High shielding effectiveness to avoid interference

Microwave cable assemblies

Eacon is a flexible cable and connector solution for high performance field installation. The two piece connector design enables a fast and reliable termination for applications up to 18 GHz. Additional armored options are available to further improve reliability under harsh conditions.



Lightning protectors

Surge protective device GDT technology provides reliable protection against dangerous surge signals on coaxial lines. This includes all types of interference, e.g. resistive, magnetic field and electric field coupling, which can be caused by lightning strikes (LEMP), switching (SEMP) and other natural or man-made electrical effects such as EMP/HEMP.

- 3400 series quarter wave protectors
- Semper self-extinguishing gas capsule protectors



Fiber optic assemblies

Fiber optic cables supports the mobility of the application by reducing both the cable footprint and the overall weight of the solution. This dramatically simplifies and speeds up the installation and maintenance of the system. The use of HUBER+SUHNER's RADOX® technology ensures superior performance in harsh environments. The Q-ODC-12 connects up to 12 fibers in a single mating step, providing both increased flexibility and fast installation.



GPS-over-Fiber

GPS-over-Fiber enables a single GPS signal to be distributed into multiple receiver systems. The small form factor adds significant value within the vehicle with both the conversion modules and FO cable designed to use as little space as possible, while eliminating all forms of (EM and RF) interference.

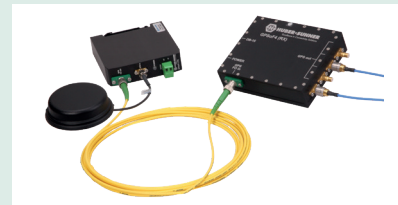

Antennas

HUBER+SUHNER provides broadband antenna solutions for vehicle-mount applications for both tactical communication and electronic countermeasure (ECM). The ruggedized designs ensure system reliability even under the harshest environments, mounted on vehicles, man packs or in fixed installations on shelters, mast or containers.

- High power levels (up to 800 W)
- Frequency bands avail. in the range of DC – 10 GHz



Power distribution cables

HUBER+SUHNER offers single and multi-core cables for power distribution using our patented cross-linked RADOX® material. RADOX® is ideal for use in a wide range of applications, where space is at a premium and where cables are subjected to high temperatures. We also offer some cables that are resistant to both high humidity and motor vehicle fluids, as well as maintaining the small bend radius required in vehicles.

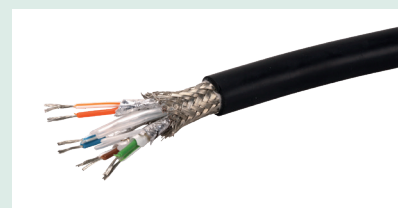

Tactical equipment/submodules

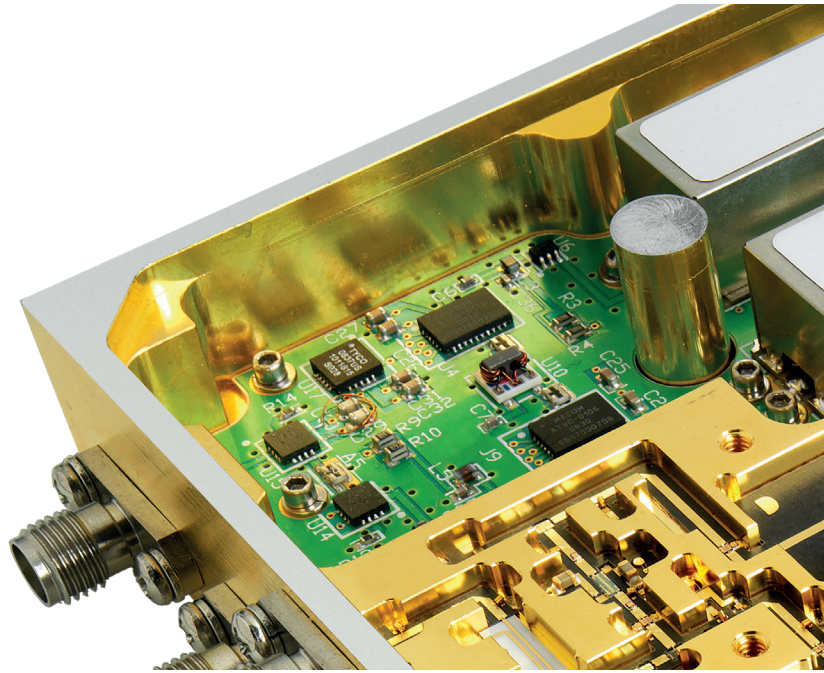

Integration density continues to increase with new generations of tactical equipment, including portable jammers, software defined radios and microwave submodules. HUBER+SUHNER provides a broad range of standard connectors, adaptors and lightning protectors to meet these requirements, as well as the ability to offer application specific designs. With in-house R+D and machining capabilities, HUBER+SUHNER can develop a custom design and quick-turn verification samples. As one of the leading companies of board-to-board solutions, HUBER+SUHNER offers an extensive array of board-to-board interconnect solutions and can achieve the smallest board-to-board footprint while still achieving outstanding electrical performance.

Applications

- Mobile jammer units
- Software Defined Radios (SDR)
- RF/Microwave submodules

Requirements

- High integration density, smaller footprint
- Reliable, hardened equipment (EMP)
- Customer specific options, backplane card mounting

Microwave cable assemblies

HUBER+SUHNER flexible microwave cable assemblies offer superior electrical and mechanical performance for static and dynamic applications. These assemblies provide optimal performance up to 90 GHz, where stringent electrical requirements are important.

- Minibend

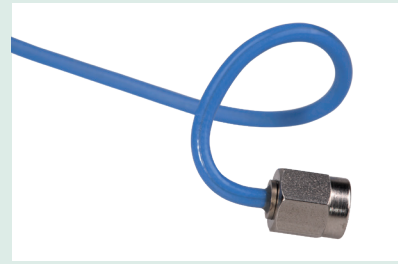

Board-to-board connectors

Board-to-board connectors are the answer to higher integration and miniaturization, where there is not space for cable assemblies. The MBX/MMBX and SMP/SMPM series offers a wide range of connectors for both board-to-board applications and complex stack-ups with multiple connections in radio module equipment.



Connectors

HUBER+SUHNER is a leading global provider of radio frequency connectors and adaptors for the transmission of analog and digital signals. In addition to a broad selection of standard connectors for a wide range of different applications, customer-specific solutions are also developed and manufactured.



VITA 67

Our VITA 67 is the first high performance true 65 GHz SMPM cable assembly in the market. Thanks to the solderless Minibend bend-to-the-end technology tightest bending radius (0.06"/1.5 mm) is applicable immediately behind the connector. The snap-in captivation method guarantees an easy and quick installation without any tools or loose parts.

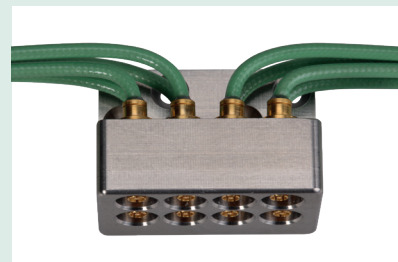

Lightning protectors

Surge protective device GDT technology provides reliable protection against dangerous surge signals on coaxial lines. This includes all types of interference, e.g. resistive, magnetic field and electric field coupling, which can be caused by lightning strikes (LEMP), switching (SEMP) and other natural or man-made electrical effects such as EMP/HEMP. An extensive high-voltage impulse laboratory is also available for customer specific design verification



Lab testing

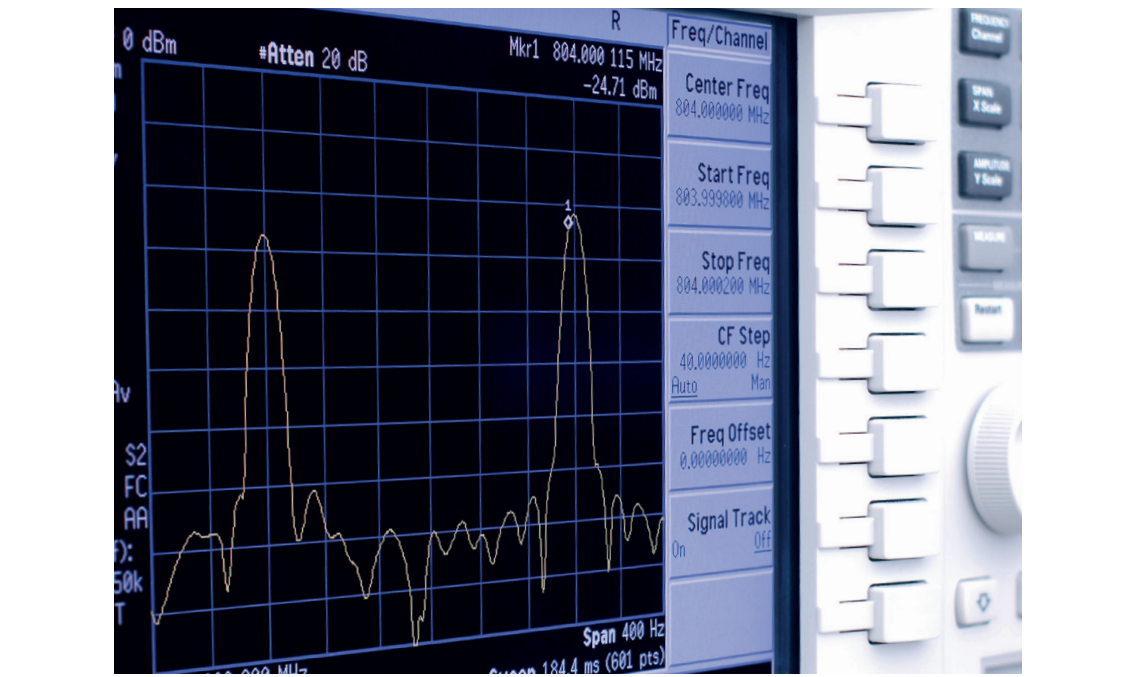

Every research and development, test, or quality assurance department that works with RF signals requires precise and repeatable measurements.

Since the quality of a test configuration is only as strong as the weakest link, HUBER+SUHNER offers a wide range of superior flexible and rugged cable assemblies with excellent amplitude and phase stability and high-precision connectors. In addition, we have a full portfolio of adaptors, resistive terminations and attenuators. Reliable cable assembly and resistive solutions guarantee reduced equipment downtime.

Applications

- Test labs
- Test benches
- Anechoic chambers

Requirements

- Lowest loss cable assemblies
- Ruggedized cables to ensure long life
- Broad range of stock assemblies to provide short leadtime

Further informations

[External document](#) 

Microwave cable assemblies

HUBER+SUHNER flexible microwave cable assemblies offer superior electrical and mechanical performance for static and dynamic applications up to 50 GHz. Additional armored options are available for each series to ensure consistent performance even under harsh environmental conditions. Stock assemblies are available to support fast delivery.

- SUCOFLEX 100
- SUCOFLEX 200



Test leads

HUBER+SUHNER test leads are designed for daily use in component and assembly shops, test labs and high speed digital testing applications. Stock assemblies are available to support fast delivery.

- Sucotest 18 (A)
- Sucotest 26
- Sucotest 40



Precision adaptors

HUBER+SUHNER manufactures a wide range of standard and high-performance adaptors that are ideal for lab and production test applications where measurement accuracy, repeatability, and optimum electrical performance are critical.



Attenuators, terminations and DC blocks

HUBER+SUHNER offers a comprehensive range of high-quality radio frequency attenuators, terminations and DC blocks for applications up to 18 GHz.



Microwave cable assemblies

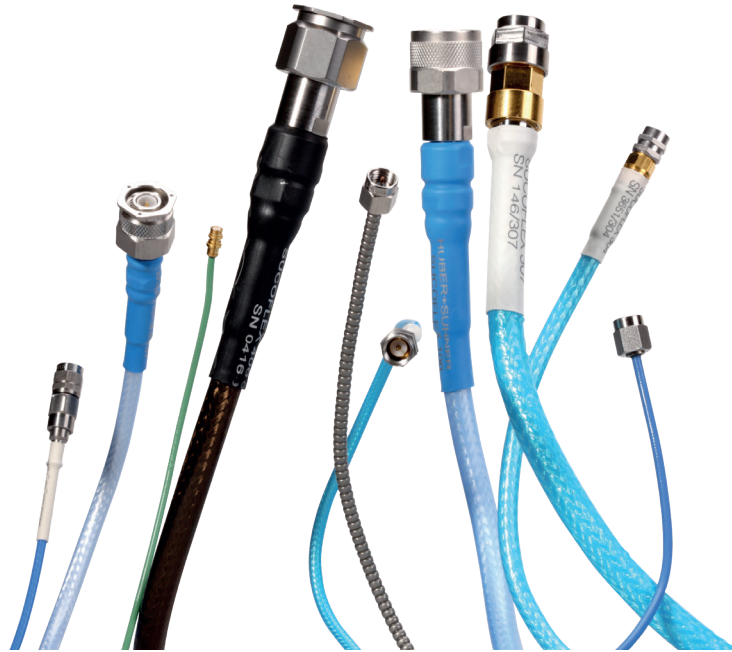

Cables and connectors from the same manufacturer

HUBER+SUHNER develops and manufactures coaxial cables and connectors for a broad array of applications world-wide. Connectors and cables can be optimized for superior electrical performance, offering over 1700 different configurations.

Customers can trust the reliability and quality of HUBER+SUHNER products which are designed and tested per IEC, MIL, CECC among other standards.

Our extensive know-how in RF technology and state of the art manufacturing facilities allow our teams to offer reliable and competent technical consulting and support. HUBER+SUHNER engineers have vast experience assisting projects optimizing cable connector combinations for the most demanding applications.

Microwave cable assemblies to your specifications

Increase efficiency and productivity in your company by ordering ready-to-use microwave cable assemblies from the specialists. Expert assembly by soldering, clamping or crimping technique and inspection records according to your specifications enabling you to order with confidence, whether built to print or from our portfolio of stock assemblies.

Further informations

[External document](#) 

SUCOFLEX 100

The low loss, high performance microwave cable assembly

- For static and dynamic applications up to 50 GHz
- Excellent return loss
- A wide range of connectors is available, including types which feature NWA-specific interfaces, and can be provided with various ruggedizations to protect the assembly against different environmental influences
- Stock assemblies available



SUCOFLEX 200

The loss revolution for dynamic applications

- For static and dynamic applications up to 40 GHz
- Ultra low loss
- Outstanding phase stability vs. temperature
- Excellent return loss

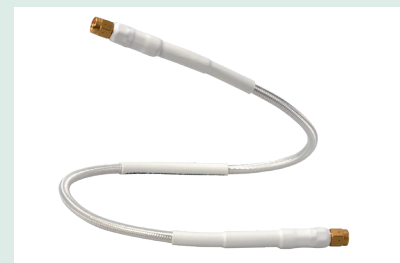

SUCOFLEX 300

The light-weight, low-loss microwave cable assemblies

- SUCOFLEX 300 series offers consistent outstanding mechanical and electrical performance, stability and reliability up to 40 GHz
- Weight reduction of up to 40 % compared to our conventional products
- Assemblies produced in a clean environment room (class 100)



SUCOFLEX 500

When it comes to test and measurement, SUCOFLEX 500 assemblies guarantee the highest level of satisfaction Torque, crush and kink resistant

- Precise and repeatable measurements
- Long service life
- Reduce total cost of test with durable, reliable performance
- Increased test and measurement efficiency saving costs due to reduced calibration intervals



Summary of SUCOFLEX® qualifications

The entire SUCOFLEX family is certified to the following standards through testing, analysis or similarity.

Temperature, altitude and humidity

MIL-STD-810, method 518.1, procedure I

Thermal shock

MIL-STD-202, method 106, condition B1, 25 cycles, temperature: -54 to 125 °C

Mechanical shock

MIL-STD-810, method 516.3, procedure I (half-sine), 20 g, 6 to 9 ms, 45 Hz cross over frequency

MIL-STD-810, method 516, procedure I (saw-tooth), 40 g saw-tooth pulse of 11 ms duration 3 shocks in each of the six directions

Vibration

MIL-STD-810, method 519.3, procedure I, figure 514.3-1, (gunfire), 26.5 min. with specified vibration profile

MIL-STD-810, method 514.3, procedure I (random), functional: 0.2 g²/Hz, endurance: 0.83 g²/Hz

MIL-STD-202; method 204, condition G (sinusoidal), acceleration: 30 g, frequency range: 10 to 2000 Hz, duration: 4 hours in each of three axes

Acceleration

MIL-STD-810, method 513.3, procedure II, 27 g, 5 min.

MIL-STD-810, method 513.3, procedure I, 50 g, 5 min.

Chemical resistance

British standard 3G100, part 2, section 3, class A

Moisture resistance

MIL-STD-202, method 106, 10 day exposure

Salt fog

MIL-STD-810, method 509.2, 48 hours exposure to a 5 % solution

Fungus

MIL-STD-810, method 508.3

Sand and dust

Def. stand. 07-55, part 2, section 4, issue 1, +35 °C, 3 hours

Solar radiation

MIL-STD-810, method 505, procedure II

Overview SUCOFLEX® 100

The high performance microwave cable assembly

Product description

SUCOFLEX 100 series flexible microwave cable assemblies offer superior electrical and mechanical performance for static and dynamic applications.

This series is a high-end product designed to provide optimal performance up to 50 GHz, where stringent electrical requirements – in particular stability and low loss – are important. Their mechanical and climate resistance properties surpass those of standard flexible cables. This cable type is ideally suited to test and measurement applications (as test leads) and used in aerospace and defence systems.



Product features

- The cable maintains stable electrical characteristics when exposed to bending and temperature, enabling reliable test results
- A balanced range of connectors is available, including types which feature NWA-specific interfaces
- Can be provided with various ruggedisations to protect the assembly against different environmental influences
- Available as assembly only

Recommended connectors

SF101 / SF101P	SMA, SK, PC2.4
SF102	SMA, BMA, N, TNC, PC3.5, SK, PC2.4
SF103	BNC, SMA, BMA, N, TNC, PC7, PC3.5
SF126 SF104	BNC, 7/16, SMA, BMA, QMA, TNC, N, QN, PC7, PC3.5
SF106 SF118	7/16, SMA, N, QN, TNC
	Other connectors available on request

Technical data

HUBER+SUHNER cable type	Operating frequency GHz	Temperature range		Outer diameter mm	Nominal atten. 18 GHz, 25 °C dB/m	Bending radii		Weight g/m
		minimum °C	maximum °C			static mm	dyn. mm	
SUCOFLEX_101	50	-55	+125	3.7	2.0	11	20	36
SUCOFLEX_101_P	50	-55	+125	3.7	3.0	11	20	33
SUCOFLEX_101_PE	50	-40	+85	3.7	3.0	11	20	30
SUCOFLEX_102	46	-55	+125	4.0	1.7	12	20	40
SUCOFLEX_102_I	46	-40	+85	4.0	1.7	12	20	36
SUCOFLEX_103	33	-55	+125	4.6	1.3	13	22	53
SUCOFLEX_103_I	33	-40	+85	4.8	1.3	13	20	53
SUCOFLEX_104	26.5	-55	+125	5.5	1.1	16	25	84
SUCOFLEX_104_I	26.5	-40	+85	6.6	1.1	16	25	82
SUCOFLEX_126	26.5	-55	+125	5.5	1.1	16	25	84
SUCOFLEX_126_E	26.5	-40	+85	5.5	1.1	16	25	83
SUCOFLEX_106	18	-55	+125	7.9	0.8	24	40	157
SUCOFLEX_118	18	-55	+125	7.9	0.8	24	40	158
SUCOFLEX_106_I	18	-40	+85	8.2	0.8	24	40	144

SUCOFLEX® 100



SUCOFLEX 100 series flexible microwave cable assemblies offer superior electrical and mechanical performance for static and dynamic applications.

This series is a high-end product designed to provide optimal performance up to 50 GHz, where stringent electrical requirements – in particular stability and low loss – are important. Their mechanical and climate resistance properties surpass those of standard flexible cables. This cable type is ideally suited to test and measurement applications (as test leads) and used in aerospace and defense systems.

Assembly types

		SUCOFLEX 101	SUCOFLEX 102	SUCOFLEX 103	SUCOFLEX 104	SUCOFLEX 126	SUCOFLEX 106	SUCOFLEX 118
Max. operating frequency	GHz	50	46	33	26.5	26.5	18	18
Impedance	Ω	50	50	50	50	50	50	50
Application		static	static	static	static	dynamic	static	dynamic
Velocity of propagation	%	77	77	77	77	77	77	77
Weight	g/m	36	40	53	73	70	145	145
Min. bending radius static	mm	11	12	13	16	16	24	24
Min. bending radius repeated	mm	20	20	22	25	25	40	40
Temperature range	°C	-55 to +125	-55 to +125	-55 to +125	-55 to +125	-55 to +125	-55 to +125	-55 to +125
Crush resistance	kN/m	8	8	8	8	8	12	12
Tensile load	N	100	150	200	250	250	400	400
Inner conductor		solid wire	solid wire	solid wire	solid wire	stranded - low loss	solid wire	stranded - low loss
Dielectric		LD-PTFE	LD-PTFE	LD-PTFE	LD-PTFE	LD-PTFE	LD-PTFE	LD-PTFE
Outer conductor		tape/braid	tape/braid	tape/braid	tape/braid	tape/braid	tape/braid	tape/braid
Jacket		FEP	FEP	FEP	FEP	FEP	FEP	FEP
Ruggedization		on request	on request	on request	on request	on request	on request	on request
Outer diameter	mm	3.7	4.0	4.6	5.5	5.5	7.9	7.9
Screening effectiveness (up to 18 GHz)	dB	> 90	> 90	> 90	> 90	> 90	> 90	> 90
Phase stability vs. flexure (360°, diameter 40 mm)	°el/GHz	< 1.2	< 1.2	< 1.4	< 1.7	< 0.9	< 2.0	< 1.2
Phase stability vs. temperature (-40 to +85 °C)	ppm	< 1500	< 1500	< 1500	< 1500	< 1500	< 1500	< 1500
Assembly phase matching tolerances	°el/GHz	± 0.5	± 0.5	± 0.5	± 0.5	± 0.5	± 0.5	± 0.5
Cable attenuation at 25 °C	dB/m	see graph	see graph	see graph	see graph	see graph	see graph	see graph
Insertion loss stability vs. bending	dB	± 0.2	± 0.2	± 0.2	± 0.2	± 0.2	± 0.2	± 0.2
Insertion loss stability vs. temperature	%/°C	< 0.2	< 0.2	< 0.2	< 0.2	< 0.2	< 0.2	< 0.2
Insertion loss stability vs. shaking	dB	± 0.1	± 0.1	± 0.1	± 0.1	± 0.1	± 0.1	± 0.1
Power handling	Watt	see graph	see graph	see graph	see graph	see graph	see graph	see graph

SUCOFLEX® 100 – graphs

Attenuation (typical values at +25 °C ambient temperature)

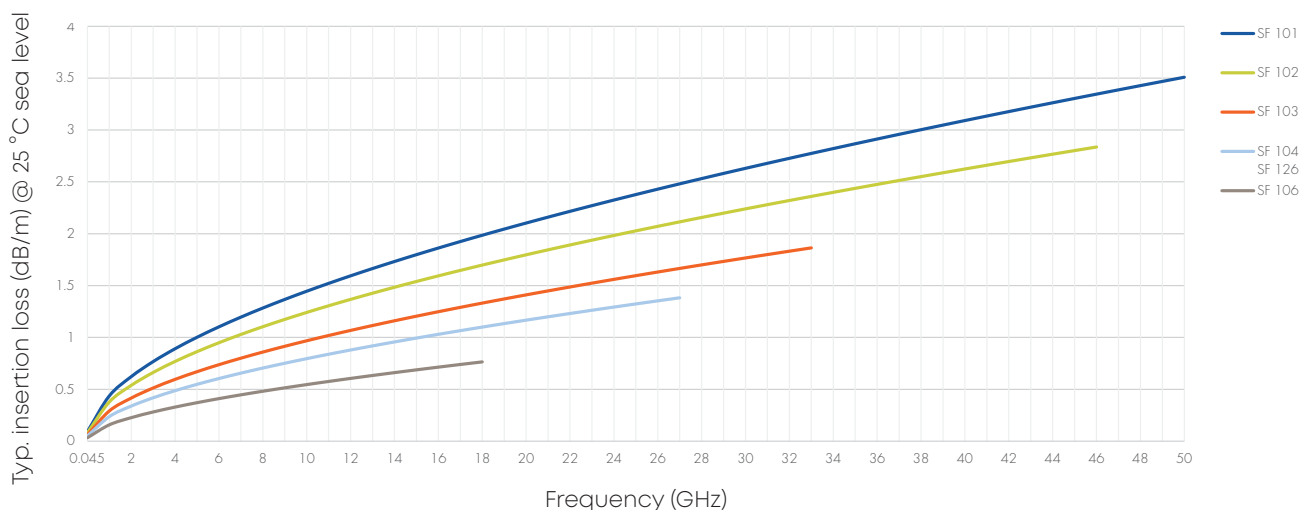

Power handling (maximum values at 25 °C ambient temperature and sea level)

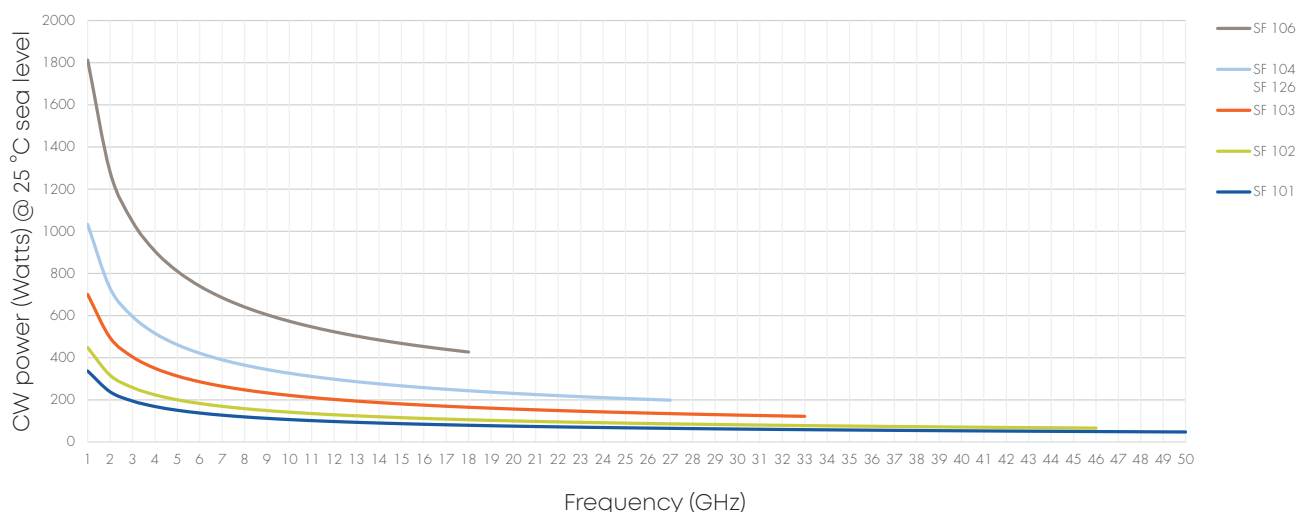

Phase stability versus temperature

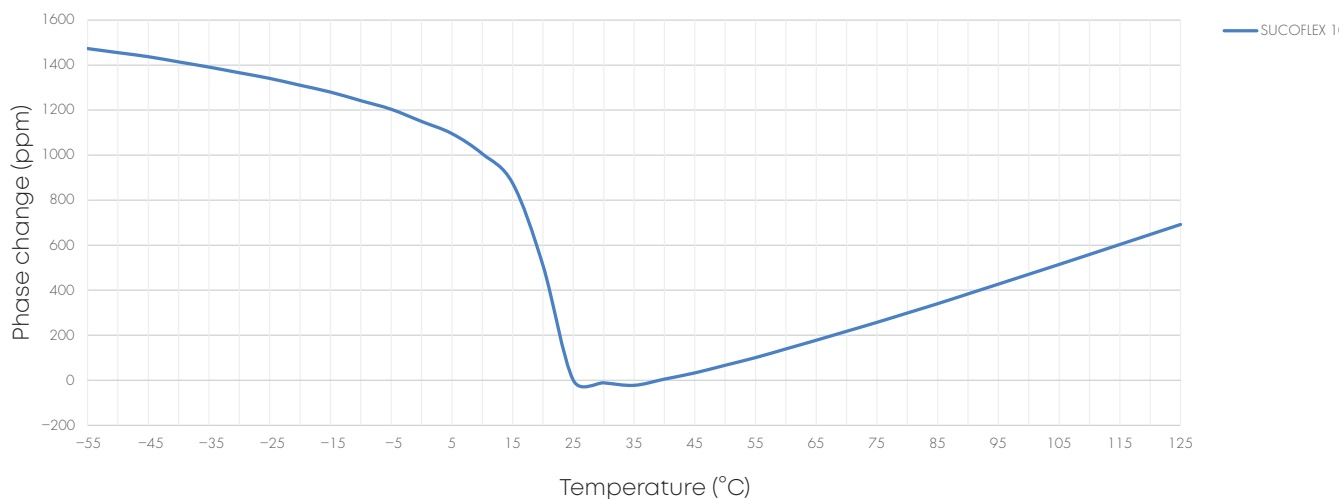

Armoring options

Type A



Consists of a steel spring (round wire), steel braid and polyurethane (TPU) jacket. Up to +85 °C, this ruggedization offers excellent protection against compression, tension, abrasion and other mechanical forces acting upon the cable.

Armoring

Surface	TPU
Max. crush resistance	80 kN/m
Torsional stiffness	$8.5 \times 10 \text{ Nm}^2/\text{°}$

Max. tensile force

Ruggedization	1500 N
Cable connector junction	400 N

Type B



Consists of a flexible hose of stainless steel. The ruggedization protects the cable against compression, abrasion, mechanical injuries, open fire and hot objects (e.g. soldering irons).

The continuous temperature is limited by the cable to +165 °C, and in the immediate proximity of the connectors to the maximum connector temperature.

Armoring

Surface	stainless steel
Max. crush resistance	80 kN/m
Torsional stiffness	$3.2 \times 10 \text{ Nm}^2/\text{°}$

Max. tensile force

Ruggedization	1000 N
Cable connector junction	500 N

Type D



Consists of an aramid yarn braid impregnated with silicon varnish. The ruggedization protects the cable against abrasion and brief high temperatures.

Armoring

Surface	aramid yarn braiding impregnated with silicon varnish
---------	---

Jacket options

Type E

Thermoplastic polyurethane (TPU) jacket for highest flexibility and a low bending moment

Type I

LSFH jacket (low smoke and free of halogen)

Qualifications

Temperature/altitude/humidity

MIL-STD-810C, method 518.1, procedure I

Thermal shock

MIL-STD-202, method 106, condition B1
25 cycles, temperature: -54 to 125 °C

Mechanical shock

MIL-STD-810D, method 516.3, procedure I (half-sine)
20 g, 6 to 9 ms, 45 Hz cross over frequency

MIL-STD-810, method 516, procedure I (saw-tooth)

40 g saw-tooth pulse of 11 ms duration
3 shocks in each of the six directions

Vibration

MIL-STD-810, method 519.3, procedure I, figure 514.3-1
(Gunfire)
26.5 min. with specified vibration profile

MIL-STD-810D, method 514.3, procedure I (random)
Functional: 0.2 g²/Hz
Endurance: 0.83 g²/Hz

MIL-STD-202; method 204, condition G (sinusoidal)
Acceleration: 30 g
Frequency range: 10 to 2000 Hz
Duration: 4 hours in each of three axes

Acceleration

MIL-STD-810D, method 513.3, procedure II
27 g, 5 min.
MIL-STD-810D, method 513.3, procedure I
50 g, 5 min.

Chemical resistance

British standard 3G100, part 2, section 3, class A

Moisture resistance

MIL-STD-202, method 106, 10 day exposure

Salt fog

MIL-STD-810D, method 509.2
48 hours exposure to a 5 % solution

Fungus

MIL-STD-810D, method 508.3

Sand and dust

Def. Stand. 07-55, part 2, section 4, issue 1
+35 °C, 3 hours

Solar radiation

MIL-STD-810, method 505, procedure II

SUCOFLEX® 200



The tape wrapped SUCOFLEX 200 microwave cable assemblies were specifically developed for applications where lowest insertion loss and highest phase stability versus temperature are required.

Assembly types

		SUCOFLEX 229	SUCOFLEX 240
Max. operating frequency	GHz	29	40
Impedance	Ω	50	50
Application		static	static
Velocity of propagation	%	82	82
Weight	g/m	61	31
Min. bending radius static	mm	23	15.2
Min. bending radius repeated	mm	70	25
Temperature range on request	$^{\circ}\text{C}$	-55 to +165 -65 to +200	-55 to +165 -65 to +200
Crush resistance	kN/m	-	-
Tensile load	N	133	133
Inner conductor		solid wire	solid wire
Dielectric		PTFE microporous	PTFE microporous
Outer conductor		flat wire braid	flat wire braid
Barrier		tape/braid	tape/braid
Jacket		FEP	FEP
Ruggedization		on request	on request
Outer diameter	mm	5.1	4.2
Screening effectiveness (up to 18 GHz)	dB	> 90	> 90
Phase stability vs. flexure (360°, diameter 55 mm)	$^{\circ}\text{el}/\text{GHz}$	< 0.65	< 0.65
Phase stability vs. temperature (-40 to +85 $^{\circ}\text{C}$)	ppm	< 600	< 600
Assembly phase matching tolerances	$^{\circ}\text{el}/\text{GHz}$	± 0.5	± 0.5
Cable attenuation at 25 $^{\circ}\text{C}$	dB/m	see graph	see graph
Insertion loss stability vs. bending	dB	± 0.2	± 0.2
Insertion loss stability vs. temperature	$\%/^{\circ}\text{C}$	< 0.21	< 0.21
Insertion loss stability vs. shaking	dB	± 0.1	± 0.1
Power handling	Watt	see graph	see graph

SUCOFLEX[®] 200 – graphs

Attenuation (typical values at +25 °C ambient temperature)

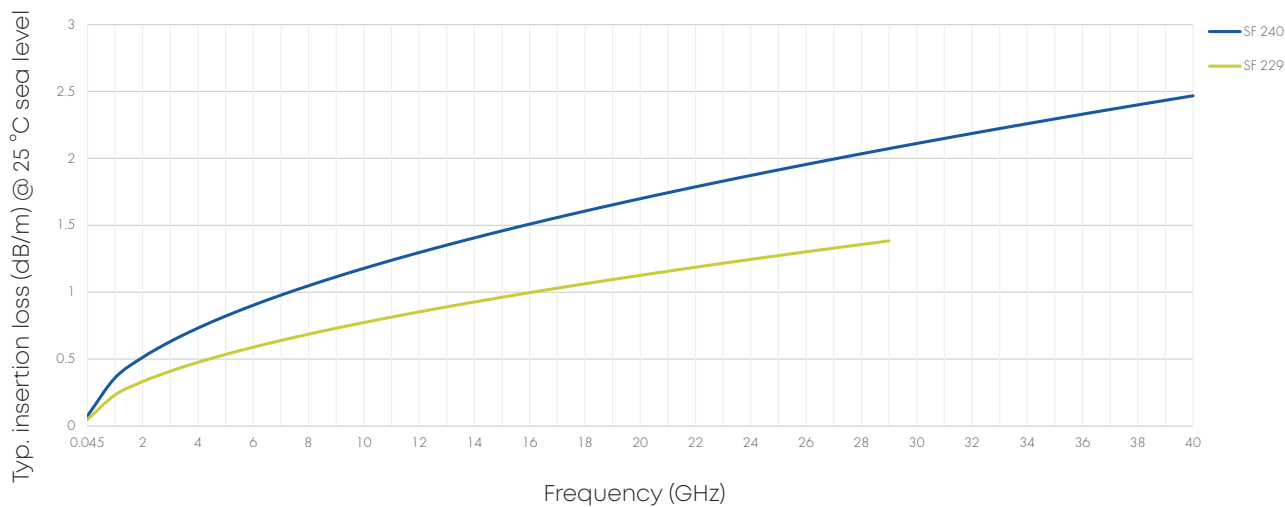

Power handling (maximum values at 25 °C ambient temperature and sea level)

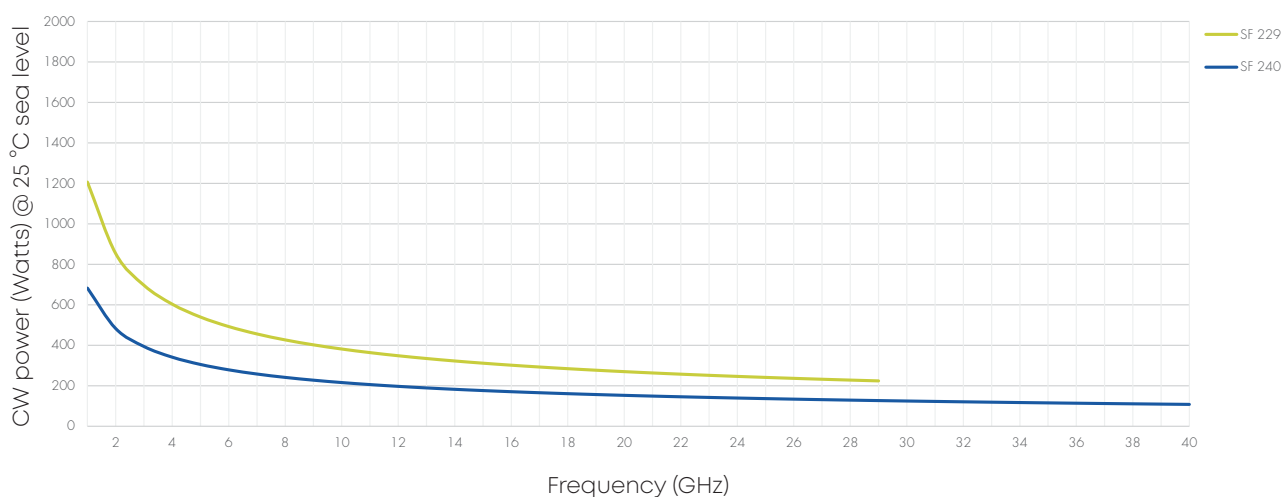

Phase stability versus temperature

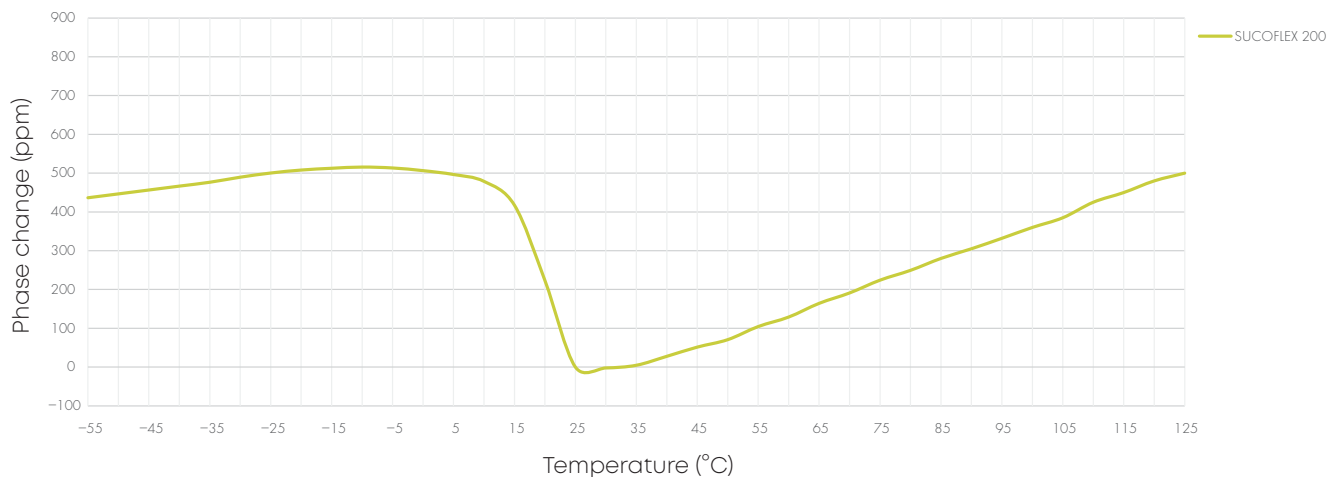

SUCOFLEX® 300



The SUCOFLEX 300 light-weight, low-loss flexible microwave cable assemblies are high-end products designed to meet the stringent needs of space flight systems (e. g. satellites) and aerospace systems (aircraft, UAVs, helicopter, missiles), which are subjected to extremely severe operating conditions.

Assembly types

		SUCOFLEX 304_Space	SUCOFLEX 307_Space	SUCOFLEX 329	SUCOFLEX 340
Max. operating frequency	GHz	18	8	29	40
Impedance	Ω	50	50	50	50
Application		static	static	static	static
Velocity of propagation	%	77	77	82	82
Weight	g/m	46	133	40	27
Min. bending radius static	mm	20	50	23	15.2
Min. bending radius repeated	mm	50	100	70	25
Temperature range	$^{\circ}\text{C}$	-55 to +125	-55 to +150	-65 to +150	-65 to +150
Tensile load	N	250	340	133	133
Inner conductor		solid wire	solid wire	solid wire	solid wire
Dielectric		PTFE microporous	PTFE microporous	PTFE microporous	PTFE microporous
Outer conductor		tape/braid	tape/braid	flat wire braid	flat wire braid
Jacket		ETFE	ETFE	ECTFE	ECTFE
Ruggedization		on request	on request	on request	on request
Outer diameter	mm	5.4	9.0	5.1	4.2
Screening effectiveness (up to 18 GHz)	dB	> 90	> 90	> 90	> 90
Phase stability vs. flexure (360°, diameter 40 mm)	$^{\circ}\text{el}/\text{GHz}$	< 1.5	< 2.0	< 0.65	< 0.65
Phase stability vs. temperature (-40 to +85 $^{\circ}\text{C}$)	ppm	< 1500	< 1500	< 1000	< 1000
Assembly phase matching tolerances	$^{\circ}\text{el}/\text{GHz}$	± 0.5	± 0.5	± 0.5	± 0.5
Cable attenuation at 25 $^{\circ}\text{C}$	dB/m	see graph	see graph	see graph	see graph
Insertion loss stability vs. bending	dB	± 0.1	± 0.1	± 0.2	± 0.2
Insertion loss stability vs. tem- perature	$\%/^{\circ}\text{C}$	< 0.2	< 0.45	< 0.2	< 0.2
Insertion loss stability vs. shaking	dB	± 0.1	± 0.1	± 0.1	± 0.1
Power handling	Watt	see graph	see graph	see graph	see graph
Radiation-gamma	Mrad	100	100	200	200

SUCOFLEX® 300 – graphs

Attenuation (typical values at +25 °C ambient temperature)

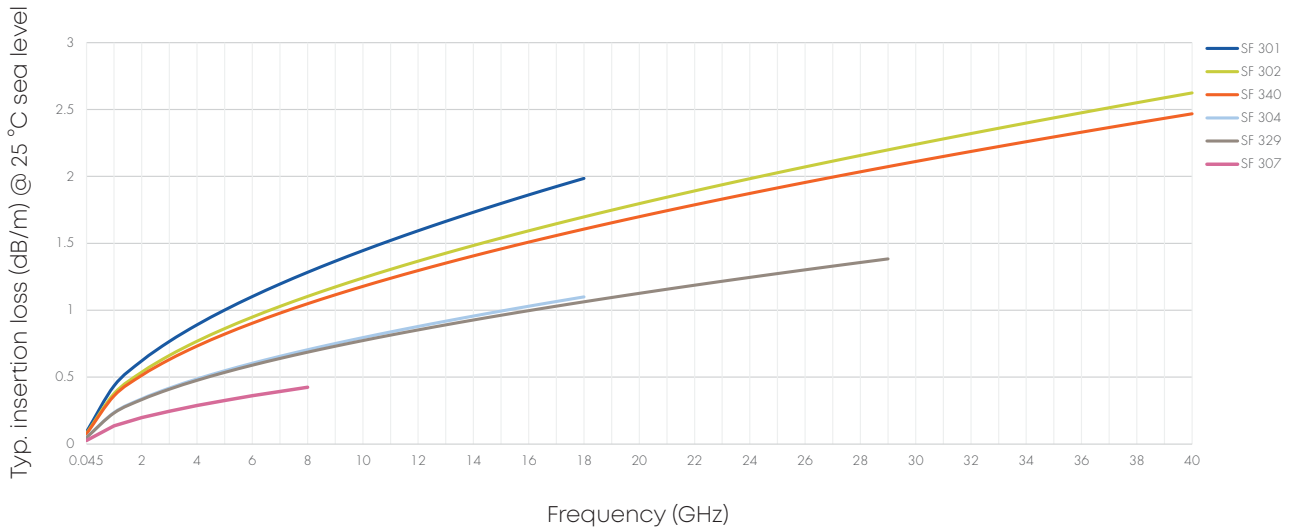

Power handling (maximum values at 25 °C ambient temperature and sea level)

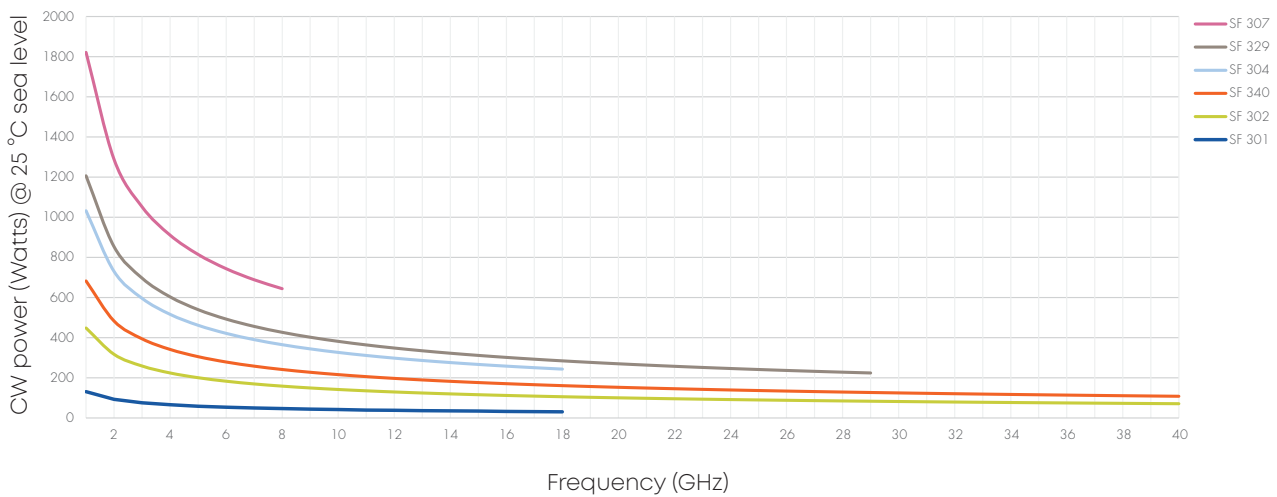

Phase stability versus temperature

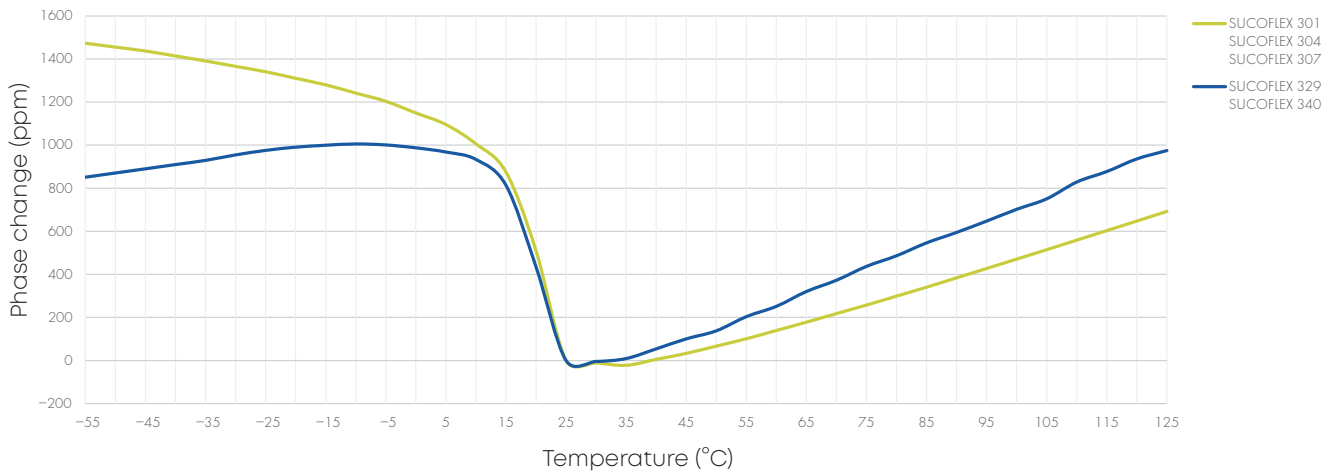

SUCOFLEX® assemblies – insertion loss comparison

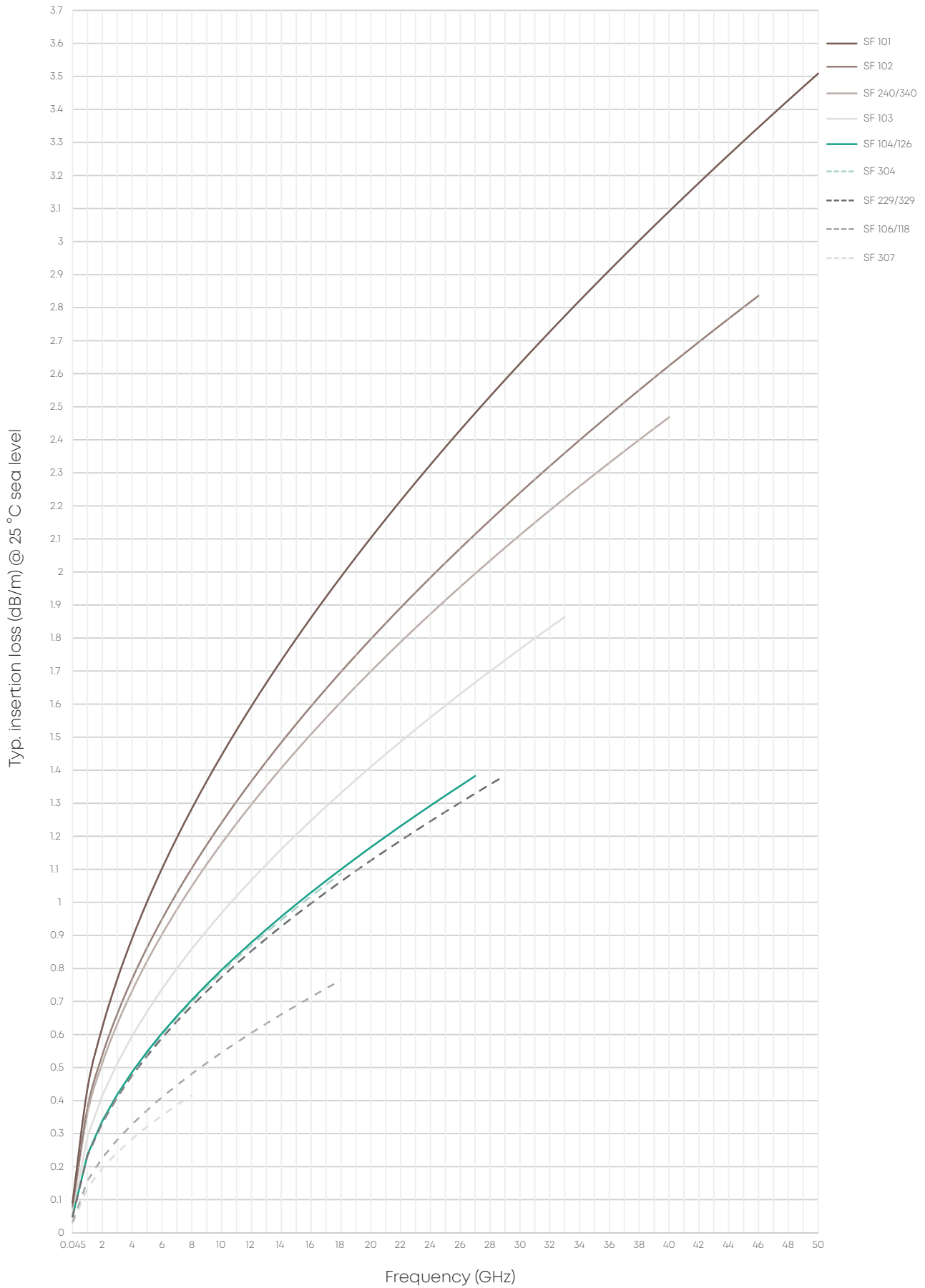

Overview SUCOFLEX® connectors

Cross reference within product range

Outer diameter mm	Cable attenuation at 18 GHz dB/m	Armoring options	Interfaces		BNC	QMA	QN	7/16	BMA	PSM	TNC	N	PC7	SMA	PC3.5	SK	PC2.4	Self- lock
			Cables															
3.7	2.0	A	SUCOFLEX 101											26.5		40	50	
3.7	3.0	A	SUCOFLEX 550													40	50	
4.0	1.7	A, D	SUCOFLEX 102					18			18	18		26.5	26.5	40	46	
4.0	1.7		SUCOFLEX 102 I					18			18	18		26.5	26.5	40	46	
4.1	1.6		SUCOFLEX 240											26.5		40		50
4.2	1.6		SUCOFLEX 340											26.5		40		50
4.6	1.3	A, D	SUCOFLEX 103	4				18			18	18	18	18	26.5			
4.6	1.3		SUCOFLEX 103 I	4				18			18	18	18	18	26.5			
5.1	1.1	A	SUCOFLEX 229								18	18		26.5		29		18
5.1	1.1		SUCOFLEX 329						18		18	18		26.5		29		18
5.4	1.1	D	SUCOFLEX 304								18			18				
5.5	1.1	A, D	SUCOFLEX 104	4	6	6	7.5	18			18	18	18	18	26.5			
5.5	1.1		SUCOFLEX 104 I	4	6	6	7.5	18			18	18	18	18	26.5			
5.5	1.1	A	SUCOFLEX 126	4			7.5	18			18	18	18	18	26.5			
7.9	0.8	A, D	SUCOFLEX 106			6	7.5				18	18		18				
7.9	0.8	A, D	SUCOFLEX 118								18	18		18				
8.2	0.8		SUCOFLEX 106 I			6	7.5				18	18		18				
8.2	0.8		SUCOFLEX 118 I								18	18		18				
9.0	-		SUCOFLEX 307								5.5							

All cable assemblies are qualified according to MIL and are available with phase match and/or armoring.

P: Stranded inner conductor for high flexible cable with improved phase variation vs. flexure

I: LSFH jacket (low smoke and free of halogen)

Stock assemblies

SUCOFLEX® 100

Item no.	Type	Length		Frequency	Max. insertion loss at 25 °C	Max. VSWR	RoHS compliant
		mm	inch	GHz			
SUCOFLEX_101							
85026753	SF101/PC24m/PC24m/500 mm	500	20	50	2.29	1.44	yes
SUCOFLEX_101_EA (armoured)							
85026754	SF101EA/PC24m/PC24m/500 mm	500	20	50	2.29	1.44	yes
SUCOFLEX_102							
84017146	SF102/SKm/SKm/500 mm	500	20	40	1.76	1.44	yes
84017149	SF102/SKm/SKm/1000 mm	1000	40	40	3.21	1.44	yes
SUCOFLEX_102_EA (armoured)							
85026755	SF102EA/SKm/SKm/500 mm	500	20	40	1.76	1.44	yes
85026756	SF102EA/SKm/SKm/1000 mm	1000	40	40	3.21	1.44	yes
SUCOFLEX_104							
84017153	SF104/Nm/Nm/500 mm	500	20	18	0.82	1.35	yes
84016754	SF104/SMAm/SMAm/500 mm	500	20	18	0.82	1.25	yes
84017154	SF104/PC35m/PC35m/500 mm	500	20	26.5	1.01	1.35	yes
84017155	SF104/SMAm/Nm/1000 mm	1000	40	18	1.43	1.30	yes
84017157	SF104/Nm/Nm/1000 mm	1000	40	18	1.43	1.35	yes
84016755	SF104/SMAm/SMAm/1000 mm	1000	40	18	1.43	1.25	yes
84017158	SF104/PC35m/PC35m/1000 mm	1000	40	26.5	1.77	1.35	yes
84017067	SF104/Nm/Nm/1500 mm	1500	59	18	2.03	1.35	yes
84016756	SF104/SMAm/SMAm/1500 mm	1500	59	18	2.03	1.25	yes
84017159	SF104/SMAm/Nm/2000 mm	2000	79	18	2.64	1.35	yes
84017160	SF104/Nm/Nm/2000 mm	2000	79	18	2.64	1.35	yes
84016757	SF104/SMAm/SMAm/2000 mm	2000	79	18	2.64	1.25	yes
SUCOFLEX_126_E							
85072824	SF126E/SMAm/SMAm/500 mm	500	20	18	0.82	1.25	yes
85072825	SF126E/SMAm/SMAm/1000 mm	1000	40	18	1.43	1.25	yes
85072826	SF126E/PC35m/PC35m/1000 mm	1000	40	26.5	1.77	1.35	yes
SUCOFLEX_126_EA (armoured)							
85072828	SF126EA/Nm/Nm/1000 mm	1000	40	18	1.43	1.25	yes
85072827	SF126EA/SMAm/SMAm/1000 mm	1000	40	18	1.43	1.25	yes
85072829	SF126EA/Nm/Nf/1500 mm	1500	59	18	2.03	1.25	yes
85072830	SF126EA/Nm/Nm/1500 mm	1500	59	18	2.03	1.25	yes

SUCOFLEX® 500



Short delivery time



Outstanding performance



Excellent price-performance ratio

When it comes to test and measurement, the SUCOFLEX 500 assemblies guarantee the highest level of satisfaction. Thanks to their unique cable and connector design, they deliver the best phase and amplitude stability versus flexure, movement, temperature and tensile stress, in combination with outstanding return and insertion loss up to 70 GHz.

Due to the rotary swaged low-loss inner conductor and the rugged construction, SUCOFLEX 500 assemblies typically withstand more than 100,000 flexures without degradation of performance and therefore have a very long life-time.

HUBER+SUHNER supplies all SUCOFLEX 500 standard length products within five working days and customised lengths are available within ten working days worldwide.

SUCOFLEX 526S

26.5 GHz

- Very long life time (>100'000 flex cycles)
- Excellent insertion loss
- Outstanding phase and amplitude stability with flexure and movement



SUCOFLEX 526V

26.5 GHz

- Extremely flexible and ease of handling
- High stable electrical performance
- Best-in-class phase and amplitude stability with flexure, movement, temperature and tensile stress



SUCOFLEX 550, 550E, 550EA, 550S

40-50 GHz

- Very long life time (>100'000 flex cycles)
- Excellent insertion loss
- Outstanding phase and amplitude stability with flexure and movement



SUCOFLEX 570S

70 GHz

- Very long life time (>20'000 Flex cycles)
- Excellent insertion loss
- Outstanding phase and amplitude stability with flexure and movement



Applications

- Bench top testing
- RF production testing
- Automated test equipment
- Vector network analyzers (VNAs)
- Scalar analyzers
- Portable test equipment
- RF module testing
- High speed digital testing (HSDT)

SUCOFLEX 526S – 26.5 GHz



Mechanical data

Frequency	26.5 GHz
Cable	SUCOFLEX 526S
Connectors	3.5mm, SMA, N
Diameter (mm)	7.7
Min. bending radius (mm)	25.4
Typ. flex life (cycles)	> 100'000
Min. assembly length (mm)	300
Max. assembly length (mm)	50'000

Environmental data

Operating temperature (°C)	-55 to +125
2011/65/EC (RoHS)	compliant
2006/1907/EC (REACH)	compliant
2012/19/EU (WEEE)	relevant

Electrical data

Impedance (Ω)	50
Velocity of propagation (%)	77
Typ. return loss (dB)	25
Min. return loss (dB)	19
Typ. insertion loss assembly (dB/m)	1.63
Max. insertion loss assembly (dB/m)	1.77
Min. screening effectiveness (dB) up to 18 GHz	90
Typ. amplitude stability vs. movement (dB)	± 0.05
Typ. amplitude stability vs. flexure (dB)	± 0.05
Typ. phase stability vs. bending (°)	± 3.0
Relative time delay matching: +/-1 ps	available on request
Relative time delay matching: +/-0.5 ps per pair	available on request

SUCOFLEX 526S stock assemblies

Art. No	Cable	Connector 1	Connector 2	Length (mm)	Length (inch)	Frequency (GHz)	max. IL (dB)	min. RL (dB)
85088164	SUCOFLEX 526S	3.5 mm male	3.5 mm male	914	36	26.5	1.64	19.0
85090629	SUCOFLEX 526S	3.5 mm male	3.5 mm female	914	36	26.5	1.64	19.0

SUCOFLEX 526V – 26.5 GHz

SUCOFLEX 526V

The only VNA microwave cable assembly worldwide with a typical 50 ppm phase variation vs. temperature between +15 and +30 °C. No “PTFE phase knee” at +19 °C as seen on conventional VNA test cable assemblies which cause phase variations and unstable measurements in critical laboratory conditions.



Available assemblies

Product configuration

Art. No.	85069744	85081169	85070046	85081172	85070047	85081177
Cable type	SUCOFLEX 526V					
Length	25" (635 mm)	25" (635 mm)	38" (965 mm)	38" (965 mm)	48" (1219 mm)	48" (1219 mm)
Connector 1	3.5 mm ruggedised PORT female (35VF)					
Connector 2	3.5 mm ruggedised DUT male (35VM)	3.5 mm DUT female (35F)	3.5 mm ruggedised DUT male (35VM)	3.5 mm DUT female (35F)	3.5 mm ruggedised DUT male (35VM)	3.5 mm DUT female (35F)

Mechanical data

Diameter (mm)	13
Min. bending radius (mm)	50
Crush resistance (kN/m)	80
Typ. flex life (cycles)	>100 000 2.0 Mio. for slight movements

Environmental data

Operating temperature	laboratory conditions, analyser specific (+15 to +30 °C)
2011/65/EC (RoHS)	compliant

Electrical data

Art. No.	85069744	85081169	85070046	85081172	85070047	85081177
Impedance (Ω)	50					
Operating frequency (GHz)	up to 26.5					
Velocity of propagation (%)	80					
Time delay (ns/m)	4.15					
Return loss (dB)	typ. 25 min. 20					
Insertion loss (dB)	max. 2.5		max. 3.6		max. 4.4	
Min. screening effectiveness (dB)	> 90					
Amplitude stability vs. movement (dB)	max. 0.05					
Amplitude stability vs. flexure (dB)	max. 0.08					
Phase stability vs. flexure (°)	max. 3.9		max. 7.4		max. 10	
Phase stability vs. tensile stress (°/GHz)	max. 0.1°/GHz (100 N)					
Phase stability vs. temperature (ppm)	typ. 50 (+15 to +30 °C)					

Order information stock assemblies

Art. No.	Description
85069744	SF526V/35VF/35VM/25in
85081169	SF526V/35VF/35F/25in
85070046	SF526V/35VF/35VM/38in
85081172	SF526V/35VF/35F/38in
85070047	SF526V/35VF/35VM/48in
85081177	SF526V/35VF/35F/48in

SUCOFLEX 526V – 26.5 GHz

Phase shift vs. temperature (+15 °C to +30 °C)

		SUCOFLEX 526V	Conventional VNA test lead
Assembly length (in (mm))	Frequency (GHz)*	Phase shift /° (for 50 ppm, 80 % VOP)	Phase shift /° (for 700 ppm, 84 % VOP)
25 (635)	18	0.9	11.4
25 (635)	26.5	1.3	16.7

*Other frequencies on request

Phase stability vs. temperature performance

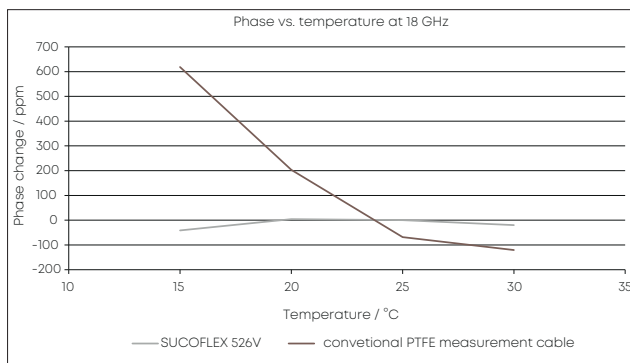

Phase stability vs. flexure

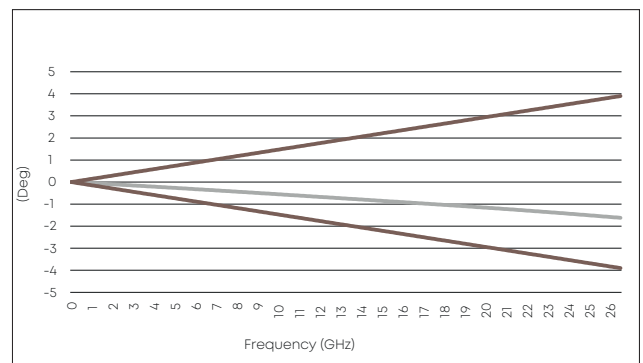

Insertion loss

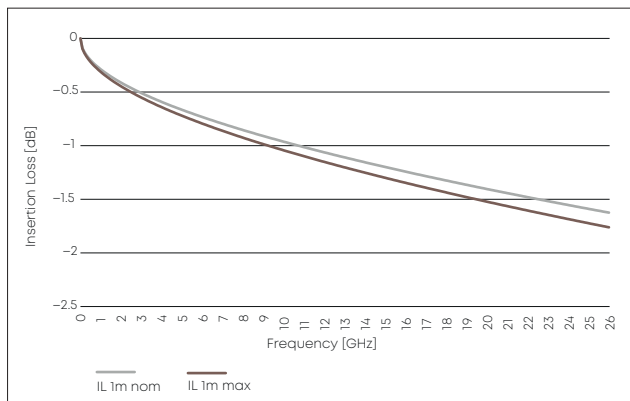

Loss stability vs. flexure

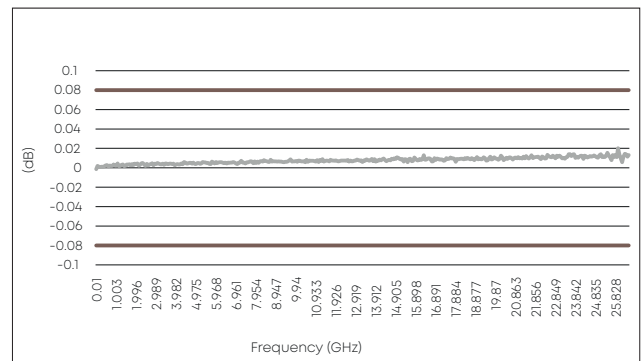

Return loss SUCOFLEX 526V with PC3.5 connectors

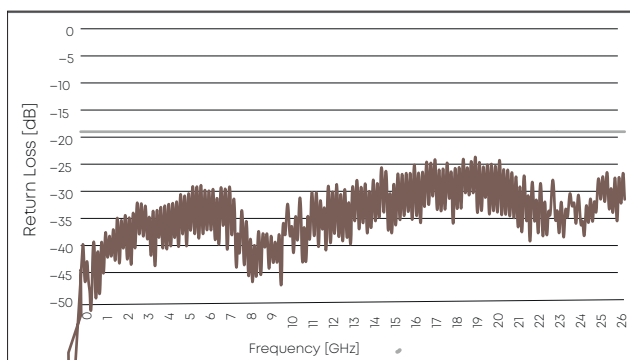

SUCOFLEX 550 – 40/50 GHz



SUCOFLEX 550S



SUCOFLEX 550



SUCOFLEX 550E



SUCOFLEX 550EA

Mechanical data

Frequency	40 GHz				50 GHz			
	SUCOFLEX 550	SUCOFLEX 550E	SUCOFLEX 550EA	SUCOFLEX 550S	SUCOFLEX 550	SUCOFLEX 550E	SUCOFLEX 550EA	SUCOFLEX 550S
Cable								
Connector	2.92 mm				2.4 mm			
Diameter (mm)	3.7	3.7	7.7	6.1	3.7	3.7	7.7	6.1
Outer jacket material	FEP	PUR	PUR	PTFE	FEP	PUR	PUR	PTFE
Crush resistant	no	no	yes	yes	no	no	yes	yes
Min. bending radius (mm)	11	11	20	25.4	11	11	20	25.4
Typ. flex life (cycles)	> 100 000				> 100 000			
Min. assembly length (mm)	300				300			
Max. assembly length (mm)	20 000	20 000	5 000	20 000	20 000	20 000	5 000	20 000

Environmental data

Operating temperature (°C)	-55 to +125	-40 to +85	-40 to +85	-55 to +125	-55 to +125	-40 to +85	-40 to +85	-55 to +125
2011/65/EC (RoHS)	compliant				compliant			
2006/1907/EC (REACH)	compliant				compliant			
2012/19/EU (WEEE)	relevant				relevant			

Electrical data

Impedance (Ω)	50							
Velocity of propagation (%)	77							
Typ. return loss (dB)	17	17	17	19	17	17	17	19
Min. return loss (dB)	15				15			
Typ. insertion loss assembly (dB/m)	3.41				3.87			
Max. insertion loss assembly (dB/m)	3.72				4.22			
Min. screening effectiveness (dB) up to 18 GHz	90				90			
Typ. amplitude stability vs. movement (dB)	± 0.1	± 0.1	± 0.1	± 0.05	± 0.1	± 0.1	± 0.1	± 0.05
Typ. amplitude stability vs. flexure (dB)	± 0.1	± 0.1	± 0.1	± 0.05	± 0.1	± 0.1	± 0.1	± 0.05
Typ. phase stability vs. flexure (°)	± 7.0	± 7.0	± 7.0	± 5.0	± 8.0	± 8.0	± 8.0	± 6.0
Relative phase matching: +/-1 ps	available on request				available on request			
Relative phase matching: +/-0.5 ps per pair	available on request				available on request			

SUCOFLEX 550 – 40/50 GHz

Stock assemblies

Art. No	Cable	Connector 1	Connector 2	Length (mm)	Length (inch)	Frequency (GHz)	max. IL (dB)	min. RL (dB)
85157329	SUCOFLEX 550E	2.4 mm male	2.4 mm male	914	36	50	4.07	14.9
85159689	SUCOFLEX 550E	2.4 mm male	2.4 mm female	914	36	50	4.07	14.9
85159690	SUCOFLEX 550E	2.92 mm male	2.92 mm female	914	36	40	3.61	14.9

Art. No	Cable	Connector 1	Connector 2	Length (mm)	Length (inch)	Frequency (GHz)	max. IL (dB)	min. RL (dB)
85120066	SUCOFLEX 550S	2.4 mm male	2.4 mm male	914	36	50	4.07	14.9
85120068	SUCOFLEX 550S	2.4 mm male	2.4 mm male	1219	48	50	5.24	14.9
85120070	SUCOFLEX 550S	2.4 mm male	2.4 mm female	914	36	50	4.07	14.9
85120072	SUCOFLEX 550S	2.4 mm male	2.4 mm female	1219	48	50	5.24	14.9
85120074	SUCOFLEX 550S	2.92 mm male	2.92 mm male	914	36	40	3.61	14.9
85120075	SUCOFLEX 550S	2.92 mm male	2.92 mm male	1219	48	40	4.65	14.9
85123657	SUCOFLEX 550S	2.92 mm male	2.92 mm female	914	36	40	3.61	14.9
85123658	SUCOFLEX 550S	2.92 mm male	2.92 mm female	1219	48	40	4.65	14.9

Absolute time delay matched assemblies

Art. No	Part No.	Connector 1	Connector 2	Length (inch)	Frequency (GHz)	max. IL (dB)	min. RL (dB) @ 67 GHz	Absolute time delay matched
85153038	PMA SF550S/11PC24/11PC24/24in	2.4 mm male	2.4 mm male	24	50	2.89	14.9	+/- 1ps
85153039	PMA SF550S/11PC24/11PC24/36in	2.4 mm male	2.4 mm male	36	50	4.07	14.9	+/- 1ps
85153050	PMA SF550S/11PC24/21PC24/36in	2.4 mm male	2.4 mm female	36	50	4.07	14.9	+/- 1ps

SUCOFLEX 570S – 70 GHz



Mechanical data

Frequency	70 GHz
Cable	SUCOFLEX 570S
Connector	1.85 mm
Diameter (mm)	5.8
Min. bending radius (mm)	25.4
Typ. flex life (cycles)	> 50 000
Min. assembly length (mm)	300
Max. assembly length (mm)	2 000

Environmental data

Operating temperature (°C)	-55 to +125
2011/65/EC (RoHS)	compliant
2006/1907/EC (REACH)	compliant
2012/19/EU (WEEE)	relevant

Electrical data

Impedance (Ω)	50
Velocity of propagation (%)	77
Typ. return loss (dB)	16
Min. return loss (dB)	15
Typ. insertion loss assembly (dB/m)	6.48
Max. insertion loss assembly (dB/m)	7.05
Min. screening effectiveness (dB) up to 18 GHz	90
Typ. amplitude stability vs. movement (dB)	± 0.05
Typ. amplitude stability vs. flexure (dB)	± 0.05
Typ. phase stability vs. flexure (°)	± 8.0
Relative time delay matching: +/- 1 ps	available on request
Relative time delay matching: +/- 0.5 ps per pair	available on request

SUCOFLEX 570S – 70 GHz

Stock assemblies

Art. No	Cable	Connector 1	Connector 2	Length (mm)	Length (inch)	Frequency (GHz)	max. IL (dB)	min. RL (dB) @ 67 GHz
85149825	SUCOFLEX 570S	1.85 mm male	1.85 mm male	914	36	70	6.48	14.0
85140576	SUCOFLEX 570S	1.85 mm male	1.85 mm female	914	36	70	6.48	14.0

Absolute time delay matched assemblies

Art. No	Part No.	Connector 1	Connector 2	Length (inch)	Frequency (GHz)	max. IL (dB)	min. RL (dB) @ 67 GHz	Absolute time delay matched
85153051	PMA SF570S/11PC185/11PC185/24in	1.85 mm male	1.85 mm male	24	70	4.65	14.0	+/- 1ps
85153052	PMA SF570S/11PC185/11PC185/36in	1.85 mm male	1.85 mm male	36	70	6.48	14.0	+/- 1ps
85153053	PMA SF570S /11PC185/21PC185/36in	1.85 mm male	1.85 mm female	36	70	6.48	14.0	+/- 1ps

SUCOFLEX 500

Available connectors

Available connectors	Freq. (GHz)	SUCOFLEX 526S	SUCOFLEX 526V	SUCOFLEX 550	SUCOFLEX 550E	SUCOFLEX 550EA	SUCOFLEX 550S	SUCOFLEX 570S
N straight male	18	SF_11_N-501						
N straight female	18	SF_21_N-501						
SMA straight male	18	SF_11_SMA-501						
3.5 mm straight male	26.5	SF_11_PC35-501						
3.5 mm straight female	26.5	SF_21_PC35-501						
3.5 mm ruggedised PORT female	26.5	SF_21_PC35-502						
3.5 mm ruggedised PORT female	26.5		35VF					
3.5 mm ruggedised DUT male	26.5		35VM					
3.5 mm DUT female	26.5		35F					
2.92 mm straight male	40			SF_11_SK-502	SF_11_SK-503	SF_11_SK-504	SF_11_SK-501	
2.92 mm straight female	40			SF_21_SK-502	SF_21_SK-503	SF_21_SK-504	SF_21_SK-501	
2.4 mm straight male	50			SF_11_PC24-502	SF_11_PC24-503	SF_11_PC24-504	SF_11_PC24-501	
2.4 mm straight female	50			SF_21_PC24-502	SF_21_PC24-503	SF_21_PC24-504	SF_21_PC24-501	
1.85 mm straight male	70							SF_11_PC185-501
1.85 mm straight female	70							SF_21_PC185-501

Order Information

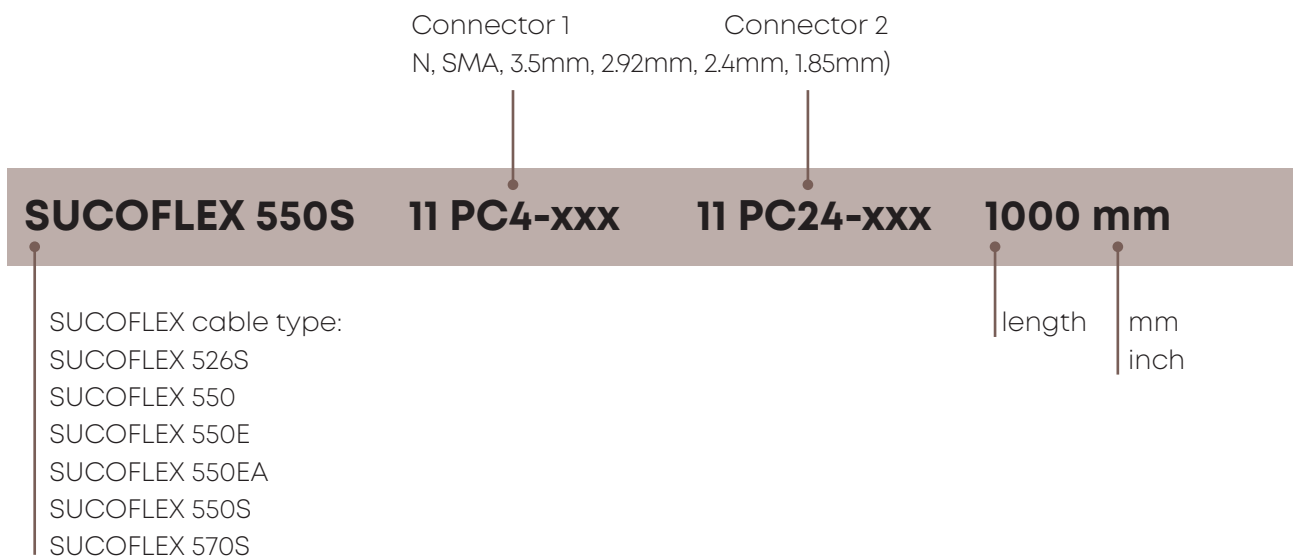

SUCOFLEX 500

Connector configuration

N male (SF_11_N-501)

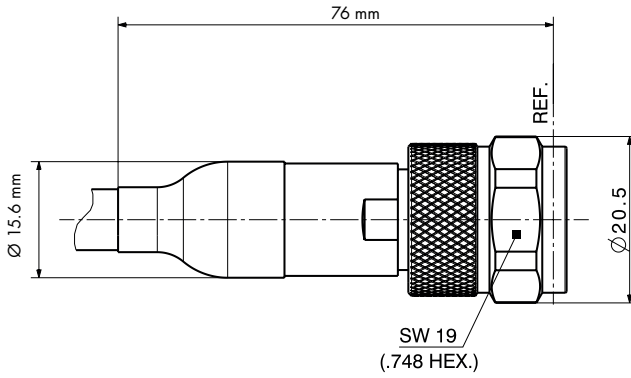

N female (SF_21_N-501)

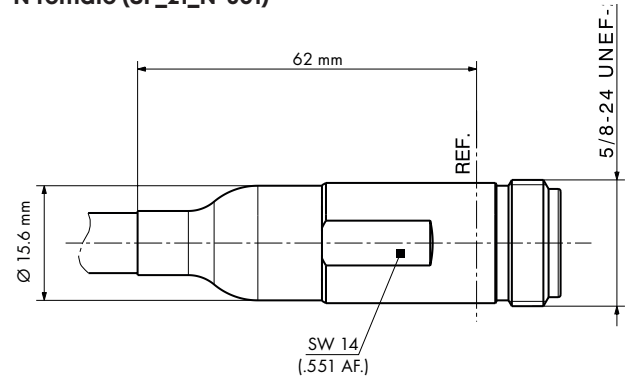

SMA male (SF_11_SMA-501)

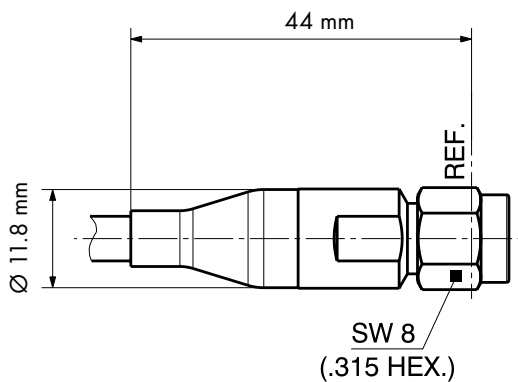

3.5 mm male (SF_11_PC35-501)

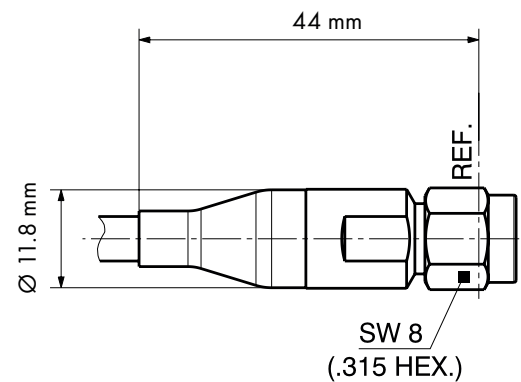

3.5 mm female (SF_21_PC35-501)

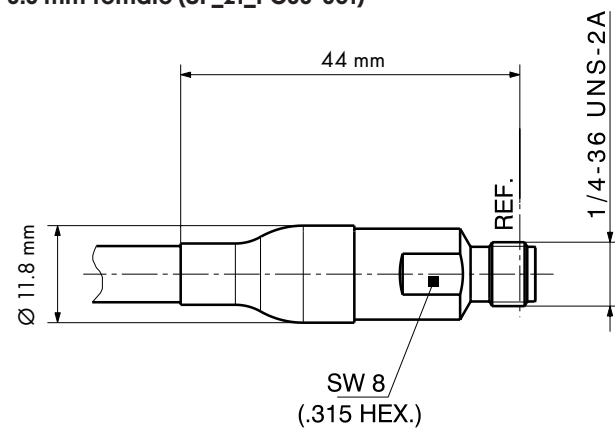

3.5 mm ruggedised PORT female (SF_21_PC35-502)

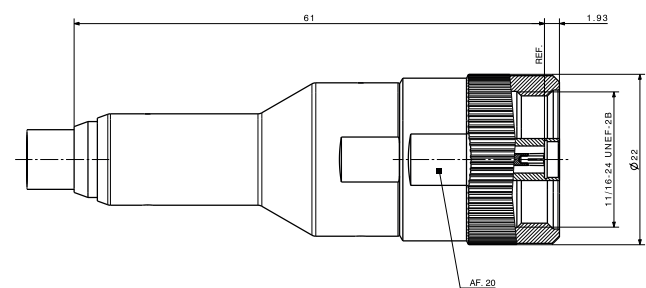

SUCOFLEX 500

35VF (3.5 mm ruggedised PORT female)

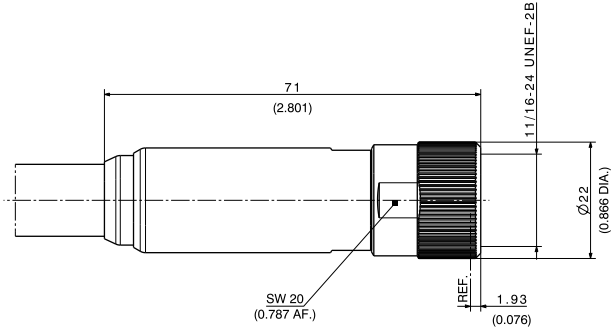

35VM (3.5 mm ruggedised DUT male)

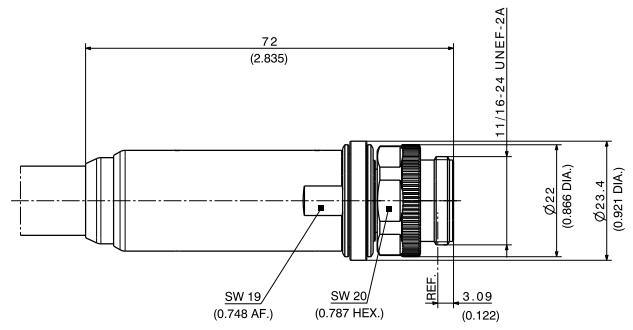

35F (3.5 mm DUT female)

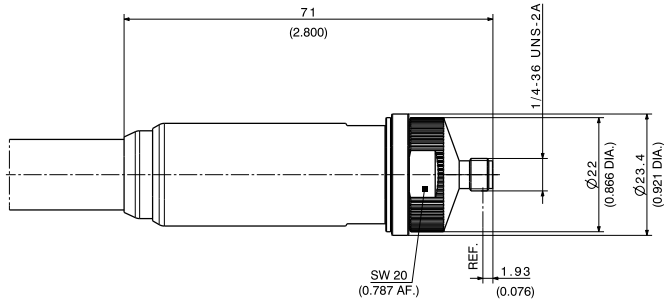

2.92 mm male (SF_11_SK-501)

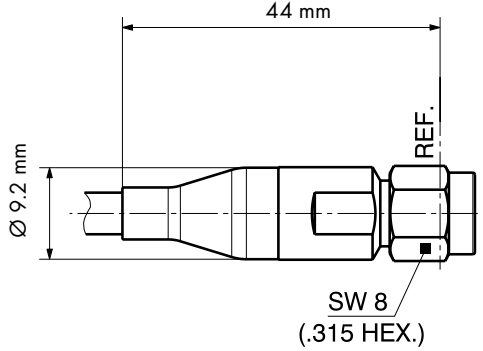

2.92 mm male (SF_11_SK-502)

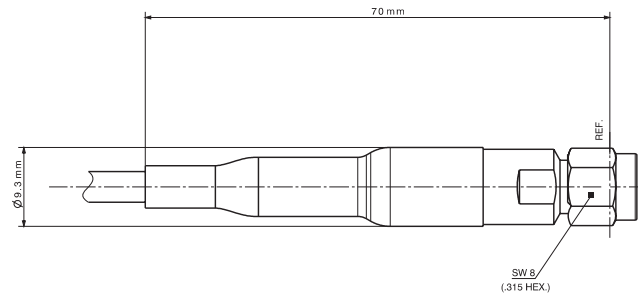

2.92 mm male (SF_11_SK-503)

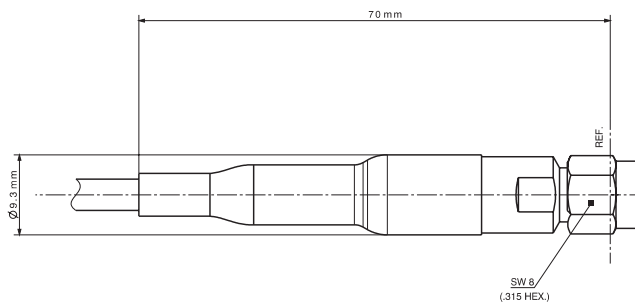

2.92 mm male (SF_11_SK-504)

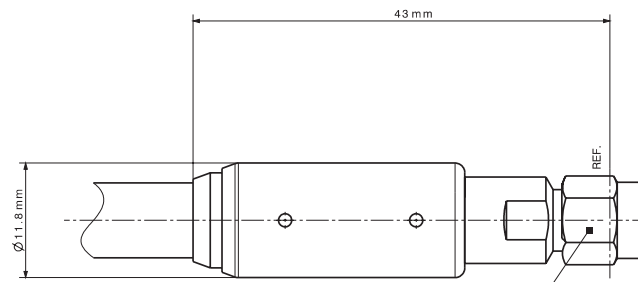

SUCOFLEX 500

2.92 mm female (SF_21_SK-501)

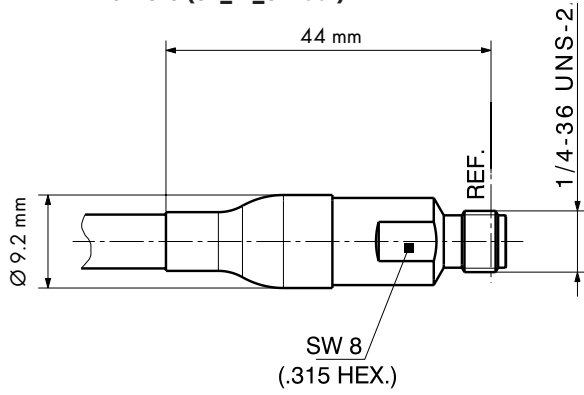

2.92 mm female (SF_21_SK-502)

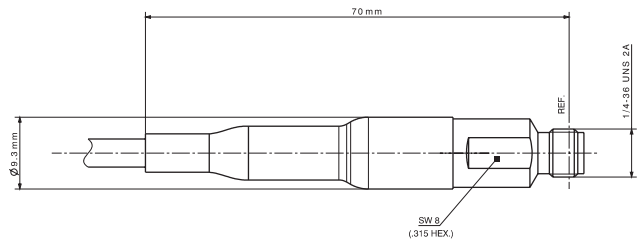

2.92 mm female (SF_21_SK-503)

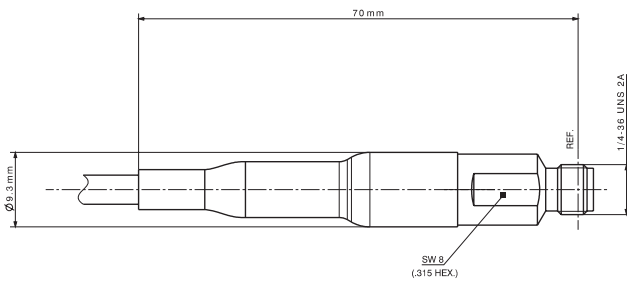

2.92 mm female (SF_21_SK-504)

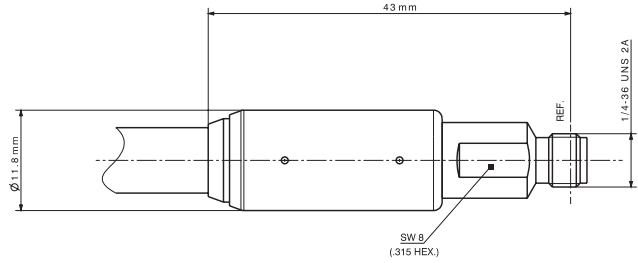

2.4 mm male (SF_11_PC24-501)

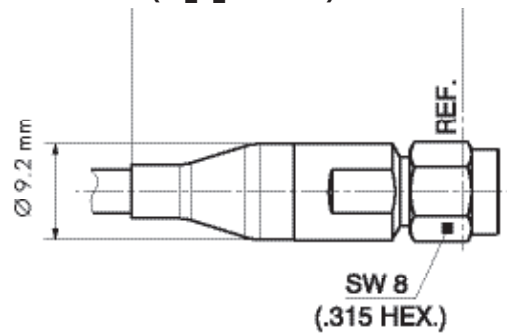

2.4 mm male (SF_11_PC24-502)

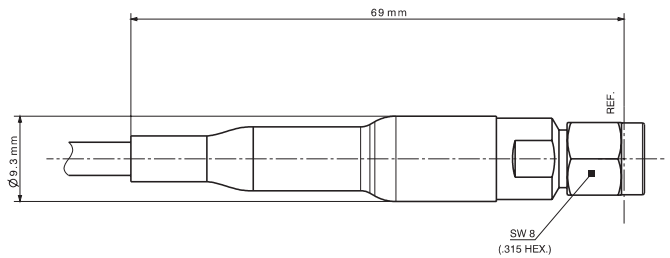

2.4 mm male (SF_11_PC24-503)

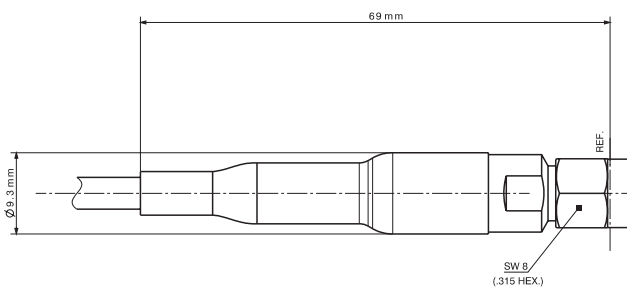

2.4 mm male (SF_11_PC24-504)

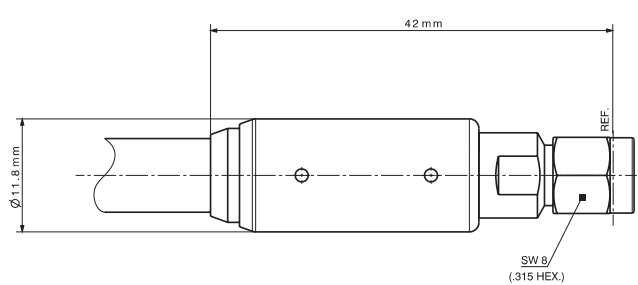

SUCOFLEX 500

2.4 mm female (SF_21_PC24-501)

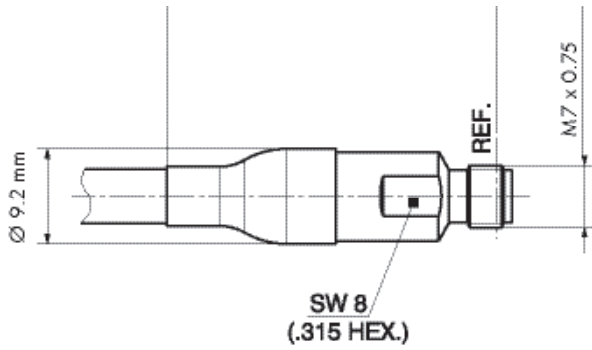

2.4 mm female (SF_21_PC24-502)

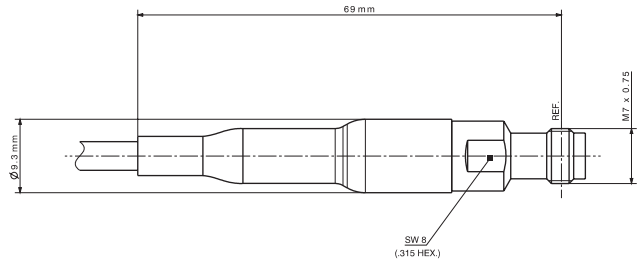

2.4 mm female (SF_21_PC24-503)

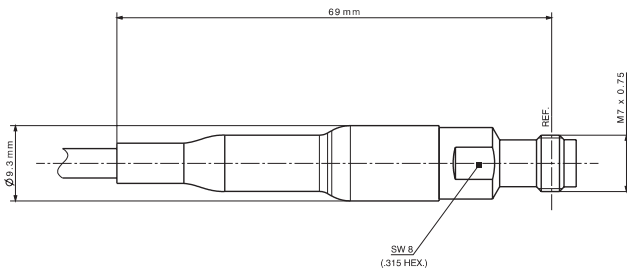

2.4 mm female (SF_21_PC24-504)

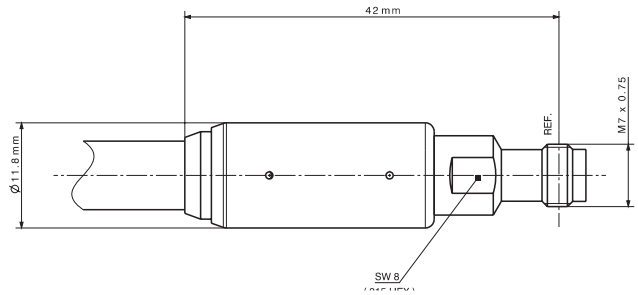

1.85 mm male (SF_11_PC185-501)

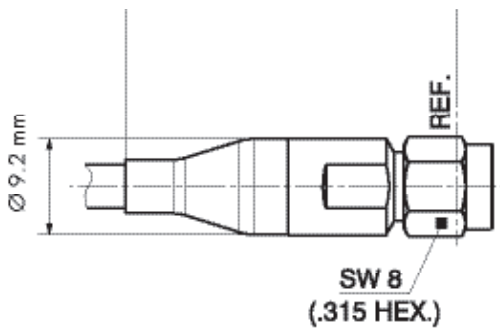

1.85 mm female (SF_21_PC185-501)

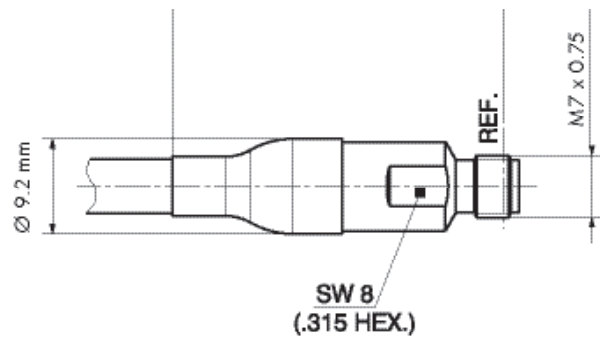

MINIBEND series



The goal of the MINIBEND series is to provide the user with incredible flexibility in both cable assembly configurations and applications.

These cables incorporate numerous features that give them the smallest bend radii in the industry without compromising isolation, stability or durability. Our connectors complement this series with a patented design that eliminates soldering and strain relief on the cable allowing for the minimum bend radius at the connector. Whether the project requires low loss, high frequency or high isolation, small connectors or small bend radii, our qualified MINIBEND series of cable assemblies will exceed your requirements.

- Light weight and low profile
- Aerospace qualification heritage
- Available as low loss and highly phase stable cables
- Solderless cable junction design

MINIBEND/MICROBEND

Low profile, high performance flexible microwave coaxial cable assemblies with solderless joints, eliminates need for costly and space-consuming right angle connectors.

- Frequency range up to 85 GHz
- Triple shielded for high isolation
- Solid PTFE dielectric
- Direct replacement for 0.086 and 0.047 inch semi-rigid cables



MINIBEND L/MICROBEND L/MINI141

Low loss, high performance, flexible microwave coaxial cable assemblies with 30 % reduction in insertion loss as compared to the solid PTFE dielectric counterparts.

- Frequency range up to 65 GHz
- Triple shielded for high isolation
- Low density PTFE dielectric
- Low loss replacement for .047, .086 and .141 inch size cables



MINIBEND CTR

The MINIBEND CTR family combines the industry-renowned flexibility of HUBER+SUHNER Astrolab's bend-to-the-end connector termination technology with industry leading phase vs. temperature performance.

- Frequency range up to 70 GHz
- Triple shielded for high isolation
- Foamed PFA Dielectric
- Eliminates need for costly right angle connectors



MINIBEND H/MINIBEND LH/MINI141 H

Ultra-low loss microwave cable assemblies and optional ECTFE jacket for highest radiation resistance.

- Frequency range up to 85 GHz
- 5 shields for improved isolation
- Solid and Low density PTFE dielectric
- Up to 200Mrad radiation resistance when using ECTFE jacket



MINIBEND series

Standard

All cables utilise triple shields for superior RF shielding, with a solid PTFE dielectric for exceptional crush resistance without the need for heavy armour. The flat wire braid outer conductor provides low loss plus excellent insertion loss stability versus flexure. The stainless steel outer braid provides improved mechanical pull strength when compared to cables with a copper wire outer braid.

- Aerospace qualification heritage
- Smallest bending radii
- Steel outer shield for high pull strength
- Solid PTFE dielectric for exceptional crush resistance without the need for heavy armour

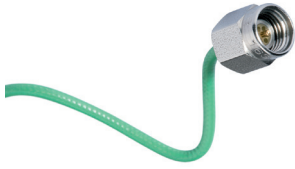
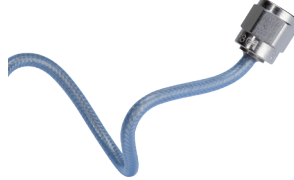
	MICROBEND R	MINIBEND R
		
Electrical specifications		
Impedance (nominal)	50 Ω	50 Ω
Velocity %	70	70
Operating frequency	DC – 85 GHz	DC – 65 GHz
Insertion loss variation vs. temperature	< 0.003 °K ⁻¹	< 0.003 °K ⁻¹
Return loss (min)	-32 dB @ 18 GHz -25 dB @ 40 GHz	-32 dB @ 18 GHz -25 dB @ 40 GHz
RF leakage	110 dB	110 dB
Resistance – insulation cable	> 10 ⁶ MΩ*m	> 10 ⁶ MΩ*m
Withstand voltage – cable assembly (at sea level)	> 1300 V	> 2000 V
Capacitance	97.4 pF*m ⁻¹	98.4 pF*m ⁻¹
Time delay	4.76 ns*m ⁻¹	4.76 ns*m ⁻¹
Phase variation vs. temperature	< 6000 ppm	< 6000 ppm
Materials and finishes		
Cable center conductor	silver plated OFHC copper	silver plated OFHC copper
Cable dielectric	solid PTFE	solid PTFE
Cable shield	silver plated copper flat wire braid	silver plated copper flat wire braid
Cable binder	aluminum/polyimide laminate tape	aluminum/polyimide laminate tape
Cable braid	stainless steel round wire braid	stainless steel round wire braid
Cable jacket	extruded FEP	extruded FEP
Cable mechanics		
Diameter	1.91 mm	2.49 mm
Minimum bending radius – static	1.52 mm	5.08 mm
Minimum bending radius – dynamic	4.57 mm	15.24 mm
Cable retention force on ruggedized cable assemblies	45 N	111 N
Weight	9.2 g*m ⁻¹	14.6 g*m ⁻¹
Environmental specification		
Temperature range	-65 to +150 °C	-65 to +150 °C
Radiation resistance	30 Mrad	30 Mrad
Out gassing according ECSS-Q-ST-70-02 and NASA reference publication 1124	TML < 1 %, CVCM < 0.1 %	TML < 1 %, CVCM < 0.1 %



MINIBEND L – series

Low loss cable assemblies

MINIBEND L is an enhanced, low loss version of the MINIBEND flexible coaxial cable assemblies. Designed to be used in low profile, internal, point-to-point interconnections between RF modules within communications systems. The low loss cable family offers 0.047, 0.086 and 0.141 inch alternatives providing 30% lower attenuation than the standard flexible cables. MINIBEND L, mini141 and microbend L have Microporous PTFE dielectric providing improved phase characteristics, such as phase versus flexure and phase versus temperature. These cables are available in a variety of preassembled configurations, tested for high performance, cost-effective alternative in a range of standard lengths.

- Microporous PTFE for superior electrical performance
- Excellent phase and IL stability over flexure
- Aerospace heritage with standard assemblies
- Light weight and low profile

	MINI141	MINIBEND LR	MICROBEND LR
			
Electrical specifications			
Impedance (nominal)	50 Ω	50 Ω	50 Ω
Velocity %	76	76	76
Operating frequency	DC – 40 GHz	DC – 50 GHz	DC – 65 GHz
Insertion loss variation vs. temperature	< 0.0015 °K ⁻¹	< 0.0015 °K ⁻¹	< 0.0015 °K ⁻²
Return loss (min)	-28 dB @ 18 GHz -20 dB @ 40 GHz	-28 dB @ 18 GHz -20 dB @ 40 GHz	-28 dB @ 18 GHz -20 dB @ 40 GHz
RF leakage	110 dB	110 dB	110 dB
Resistance – insulation cable	> 10 ⁶ MΩ*m	> 10 ⁶ MΩ*m	> 10 ⁶ MΩ*m
Withstand voltage – cable assembly (at sea level)	> 5000 V	> 2000 V	> 1300 V
Capacitance	89.2 pF*m ⁻¹	90.2 pF*m ⁻²	85.1 pF*m ⁻²
Time delay	4.39 ns*m ⁻¹	4.39 ns*m	4.39 ns*m ⁻²
Phase variation vs. temperature	< 1500 ppm	< 1500 ppm	< 1500 ppm
Materials and finishes			
Cable center conductor	silver plated OFHC copper	silver plated OFHC copper	silver plated OFHC copper
Cable dielectric	microporous PTFE	microporous PTFE	microporous PTFE
Cable shield	silver plated copper flat wire braid	silver plated copper flat wire braid	silver plated copper flat wire braid
Cable binder	aluminum/polyimide laminate tape	aluminum/polyimide laminate tape	aluminum/polyimide laminate tape
Cable braid	stainless steel round wire braid	stainless steel round wire braid	stainless steel round wire braid
Cable jacket	extruded FEP	extruded FEP	extruded FEP
Cable mechanics			
Diameter	3.61 mm	2.64 mm	2.03 mm
Minimum bending radius – static	8.38 mm	6.4 mm	5.10 mm
Minimum bending radius – dynamic	25.15 mm	19.1 mm	15.20 mm
Cable retention force on ruggedized cable assemblies	111 N	111 N	45 N
Weight	28.5 g*m ⁻¹	15.5 g*m ⁻¹	10.4 g*m ⁻¹
Environmental specification			
Temperature range	-65 to +150 °C	-65 to +150 °C	-65 to +150 °C
Radiation resistance	30 Mrad	30 Mrad	30 Mrad
Out gassing according ECSS-Q-ST-70-02 and NASA reference publication 1124	TML < 1 %, CVCM < 0.1 %	TML < 1 %, CVCM < 0.1 %	TML < 1 %, CVCM < 0.1 %

MINIBEND L – graphs

Attenuation (nominal values at +25 °C ambient temperature)

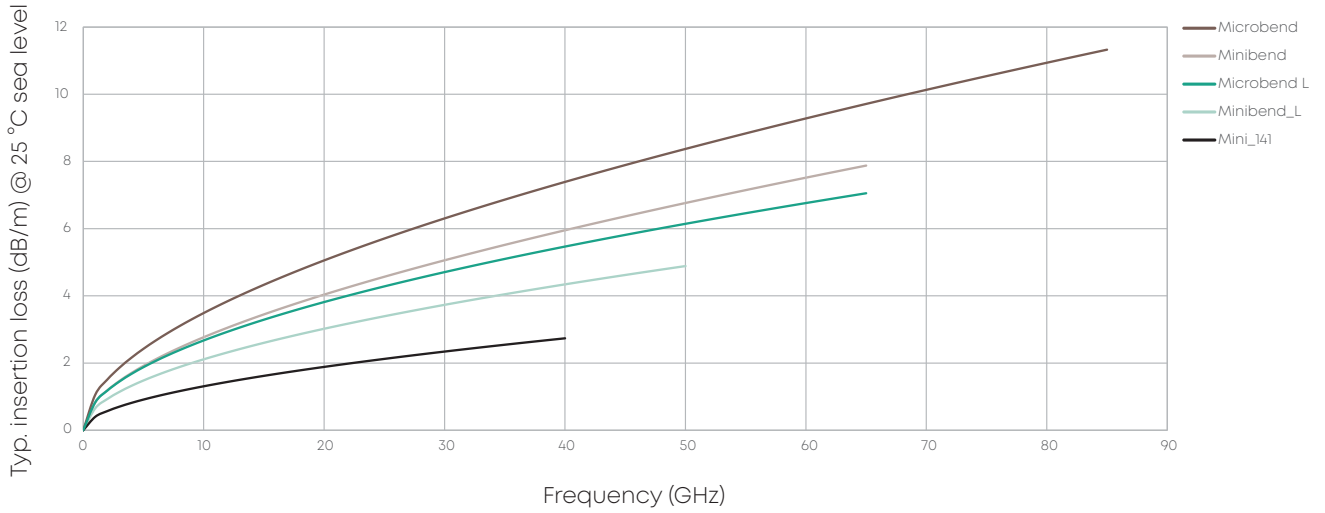

Power handling (maximum values at 25 °C ambient temperature and sea level)

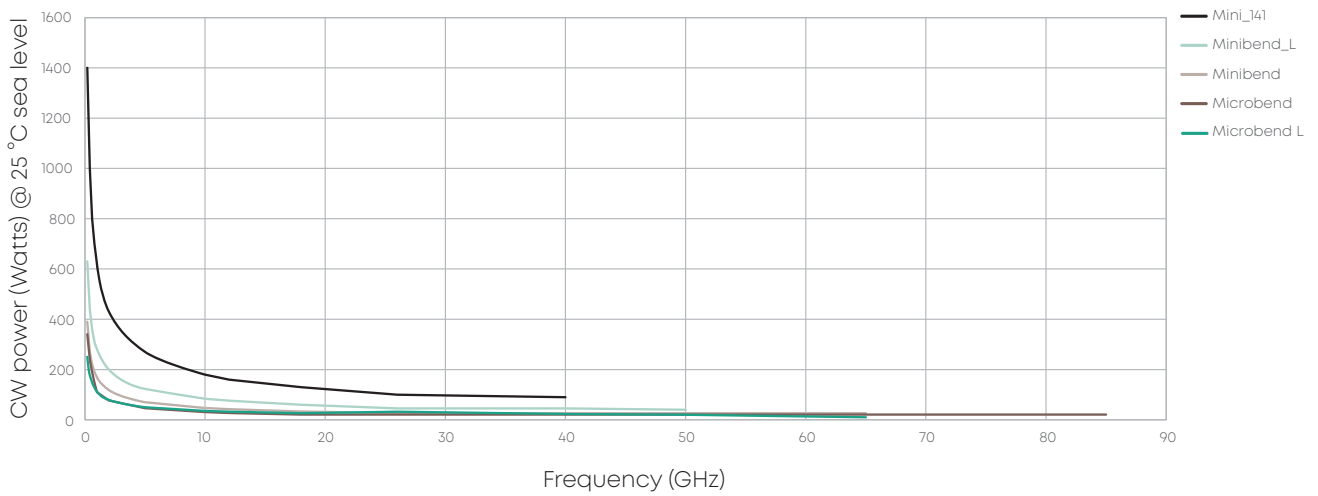

MINIBEND CTR – phase invariant cable assemblies

Phase invariant cable assemblies

The MINIBEND CTR family of cable assemblies combines the industry-renowned flexibility of HUBER+SUHNER Astrolab's solderless bend-to-the end connector termination technology with industry leading phase vs. temperature performance to create a stable, reliable, MIL-DTL-17 qualified interconnect solution to satisfy an endless range of customer applications where phase stability is key. The broad selection of connector interfaces offered on phase invariant cable assemblies ensures that we are able to meet the unique requirements of our customers.

- Increased system accuracy over temperature change
- Flat phase change over temperature
- Bend-to-the end technology
- Outstanding return loss performance
- Higher reliability due to solderless junctions

MINIBEND CTR	
	
Electrical specifications	
Impedance (nominal)	50 Ω
Velocity %	80
Operating frequency	DC – 70 GHz
Insertion loss variation vs. temperature	< 0.004 $^{\circ}\text{K}^{-1}$
Return loss (min)	-32 dB @ 18 GHz -25 dB @ 40 GHz
RF leakage	110 dB
Resistance – insulation cable	> 10 ⁶ M Ω *m
Withstand voltage – cable assembly (at sea level)	> 1200 V
Capacitance	83.3 pF*m ⁻¹
Time delay	4.17 ns*m ⁻¹
Phase variation vs. temperature	< 300 ppm
Materials and finishes	
Cable center conductor	silver plated solid OFHC copper
Cable dielectric	foamed PFA
Cable shield	silver plated copper flat wire braid
Cable binder	aluminum/polyimide laminate tape
Cable braid	stainless steel round wire braid
Cable jacket	extruded FEP
Cable mechanics	
Diameter	2.49 mm
Minimum bending radius – static	5.08 mm
Minimum bending radius – dynamic	15.24 mm
Cable retention force on ruggedized cable assemblies	111 N
Weight	14.9 g*m ⁻¹
Environmental specification	
Temperature range	-65 to +150 $^{\circ}\text{C}$
Radiation resistance	30 Mrad
Out gassing according ECSS-Q-ST-70-02 and NASA reference publication 1124	TML < 1 %, CVCM < 0.1 %

MINIBEND CTR – graphs

Attenuation (nominal values at +25 °C ambient temperature)

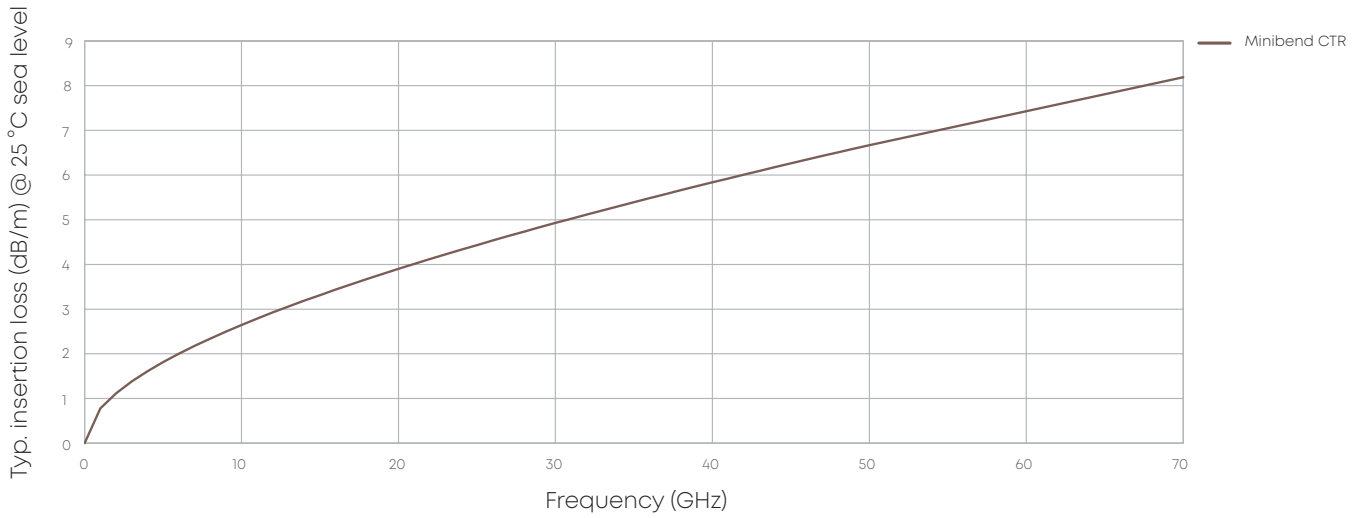

Power handling (maximum values at 25 °C ambient temperature and sea level)

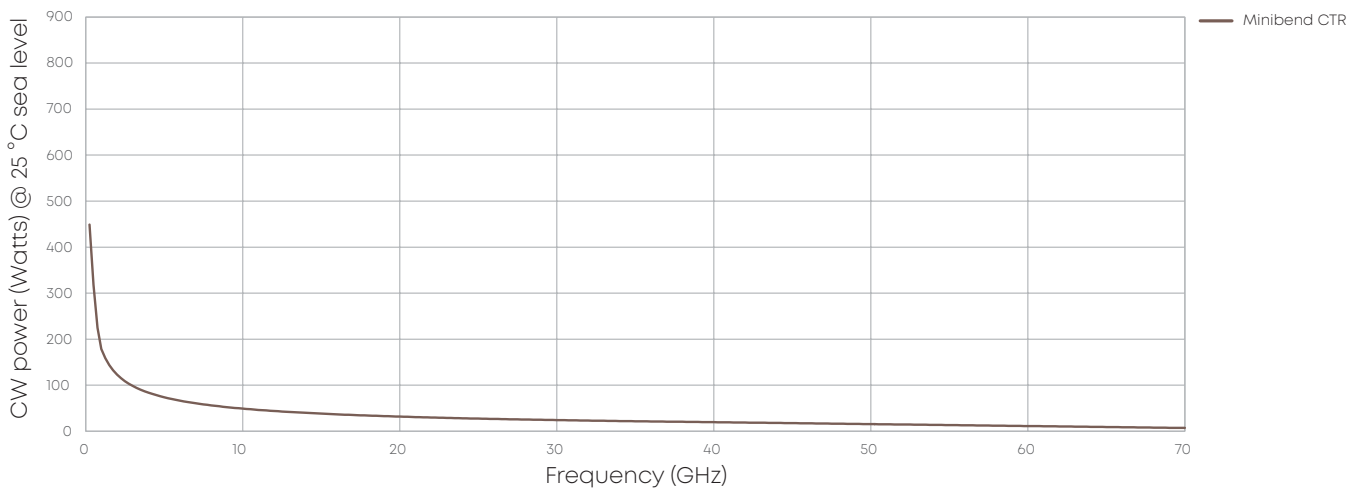

Phase stability versus temperature

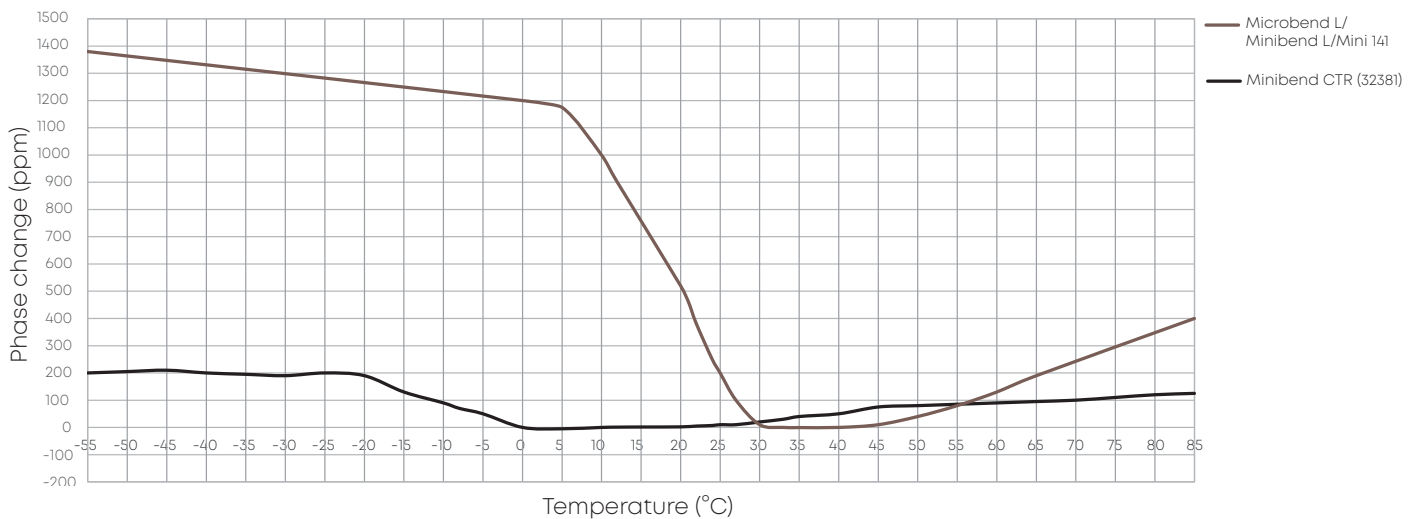

MINIBEND H – high shielded cable assemblies

HUBER+SUHNER extends the RF cable assembly portfolio with a highly shielded and ultra-low loss cables for space and defense applications. The MINIBEND H series offer a frequency range up to 85 GHz .

- Five shields for high isolation
- ECTFE jacket option (B) for high radiation resistant (200 Mrad)
- Solderless junctions for highest reliability
- Outstanding return loss performance

	MINIBEND H(B)	MINIBEND LH(B)R	MINI141H(B)
			
Electrical specifications			
Impedance (nominal)	50 Ω	50 Ω	50 Ω
Velocity %	70	76	76
Operating frequency	DC – 85 GHz	DC – 65 GHz	DC – 45 GHz
Insertion loss variation vs. temperature	< 0.003 °K ⁻¹	< 0.0015 °K ⁻¹	< 0.0015 °K ⁻¹
Return loss (min)	-32 dB @ 18 GHz	-28 dB @ 18 GHz	-28 dB @ 18 GHz
	-25 dB @ 40 GHz	-20 dB @ 40 GHz	-20 dB @ 40 GHz
RF leakage	130 dB	130 dB	130 dB
Resistance – insulation cable	> 10 ⁶ MΩ*m	> 10 ⁶ MΩ*m	> 10 ⁶ MΩ*m
Withstand voltage – cable assembly (at sea level)	> 1300 V	> 1300 V	> 5000 V
Capacitance	97.4 pF*m ⁻¹	85.1 pF*m ⁻¹	89.5 pF*m ⁻¹
Time delay	4.76 ns*m ⁻¹	4.39 ns*m ⁻¹	4.39 ns*m ⁻¹
Phase variation vs. temperature	< 6000 ppm	< 1500 ppm	< 1500 ppm
Materials and finishes			
Cable center conductor	silver plated solid OFHC copper	silver plated solid OFHC copper	silver plated solid OFHC copper
Cable dielectric	PTFE	expanded PTFE	expanded PTFE
Cable shield	silver plated OFCP flat wire copper braid	silver plated OFCP flat wire copper braid	silver plated OFCP flat wire copper braid
Cable binder	aluminum/polyimide laminate tape	aluminum/polyimide laminate tape	aluminum/polyimide laminate tape
Cable braid	stainless steel round wire braid	stainless steel round wire braid	stainless steel round wire braid
Cable braid	silver plated copper clad steel wire braid	silver plated copper clad steel wire braid	silver plated copper clad steel wire braid
Cable braid	silver plated copper clad steel wire braid	silver plated copper clad steel wire braid	silver plated copper clad steel wire braid
Cable jacket	extruded FEP (extruded ECTFE)	extruded FEP (extruded ECTFE)	extruded FEP (extruded ECTFE)
Cable mechanics			
Diameter	2.49 mm	2.54 mm	3.61 mm
Minimum bending radius – static	5.08 mm	5.08 mm	8.4 mm
Minimum bending radius – dynamic	15.24 mm	15.24 mm	25.2 mm
Cable retention force on ruggedized cable assemblies	111 N	111 N	111 N
Weight	18.1 g*m ⁻¹	18.1 g*m ⁻¹	40.5 g*m ⁻¹
Environmental specification			
Temperature range	-65 to +150°C	-65 to +150°C	-65 to +150°C
Radiation resistance	30 Mrad (200 Mrad)	30 Mrad (200 Mrad)	30 Mrad (200 Mrad)
Out gassing according ECSS-Q-ST-70-02 and NASA reference publication 1124	TML < 1 %, CVCM < 0.1 %	TML < 1 %, CVCM < 0.1 %	TML < 1 %, CVCM < 0.1 %

MINIBEND H – graphs

Attenuation (nominal values at +25 °C ambient temperature)

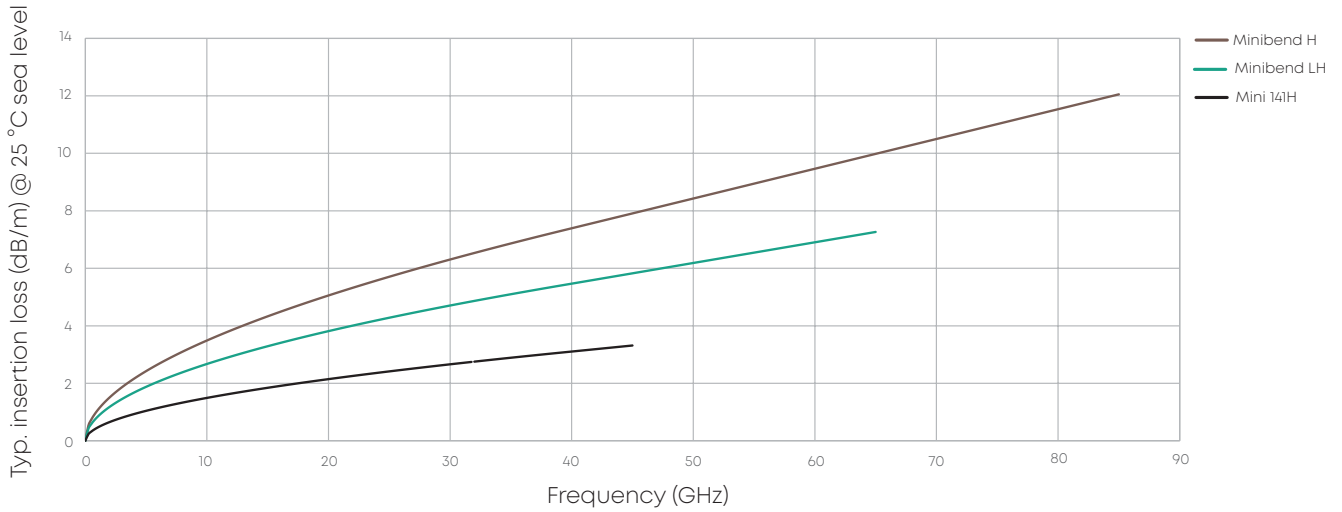

Power handling (maximum values at 25 °C ambient temperature and sea level)

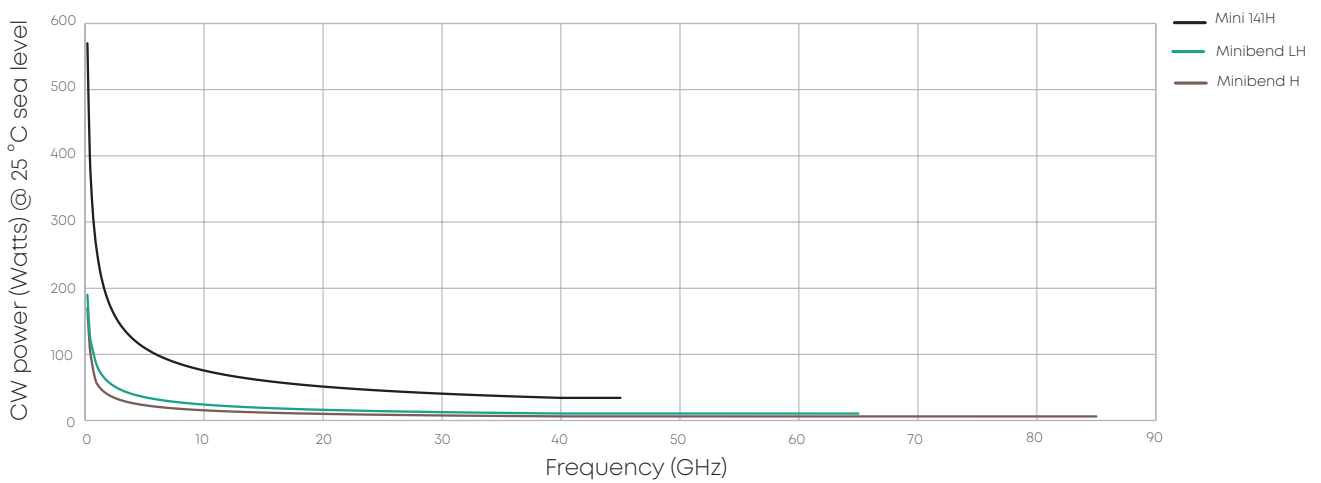

NANO BEND™

What is it? NANO BEND™ is a new and flexible, high-frequency coaxial cable assembly that is designed for use in low profile, internal, point-to-point interconnections between RF modules within communications systems. As the newest entrant found in the MINIBEND™ family of standard flexible cables, NANO BEND brings the same capabilities you depend on, but now in the smallest diameter available.



Product features

- Impedance 50 Ω
- Applicable up to 110 GHz
- Stock delivery on standard lengths
- Connections available that are found nowhere else in our current product offerings, including: Size 12 SMPM, Size 16 SMPS, Nanominiature Connections (pictured at right), VITA 67.1/2 SMPM, VITA 67.3 SMPM and SMPS, and more

Available Cable Connectors

Compatible connectors (other connectors may be made available upon request)

HUBER+SUHNER®-designed Nanominiature Connections, both Plug and Jack
SMA and SMA Bulkhead
SMPM
SMP
SK
Size 12 SMPM
Size 16 SMPS
HUBER+SUHNER-designed and TE®-compatible NANO RF Connections, both Plug and Jack
VITA 67.1/2 and VITA 67.3 SMPM Connector
VITA 67.3 SMPS Connector

Construction

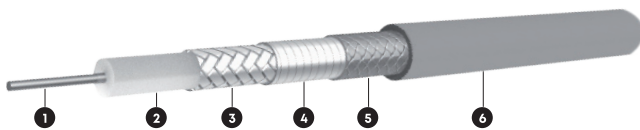

Cable	Inner Conductor	Dielectric	Outer Conductor	Barrier	Outer Braid	Jacket	Outer Diameter
	1	2	3	4	5	6	
32061SE	CuAg (SPC) Wire	Extruded PTFE	CuAg (SPC) flat wire braid	Aluminum / Polyimide Tape	Stainless Steel Braid	FEP	1.6 mm

Cable	Operating Frequency	Velocity (nominal)	Weight (nominal)	Static Min. Bend Radius	Impedance	Temp. Range
	GHz	%	g/m	mm	Ω	°C
32061SE	110	70.3	14.9	5.08	50	-55 to +200

NANO BEND™

Attenuation (dB/m) vs Frequency (GHz) of 32061SE

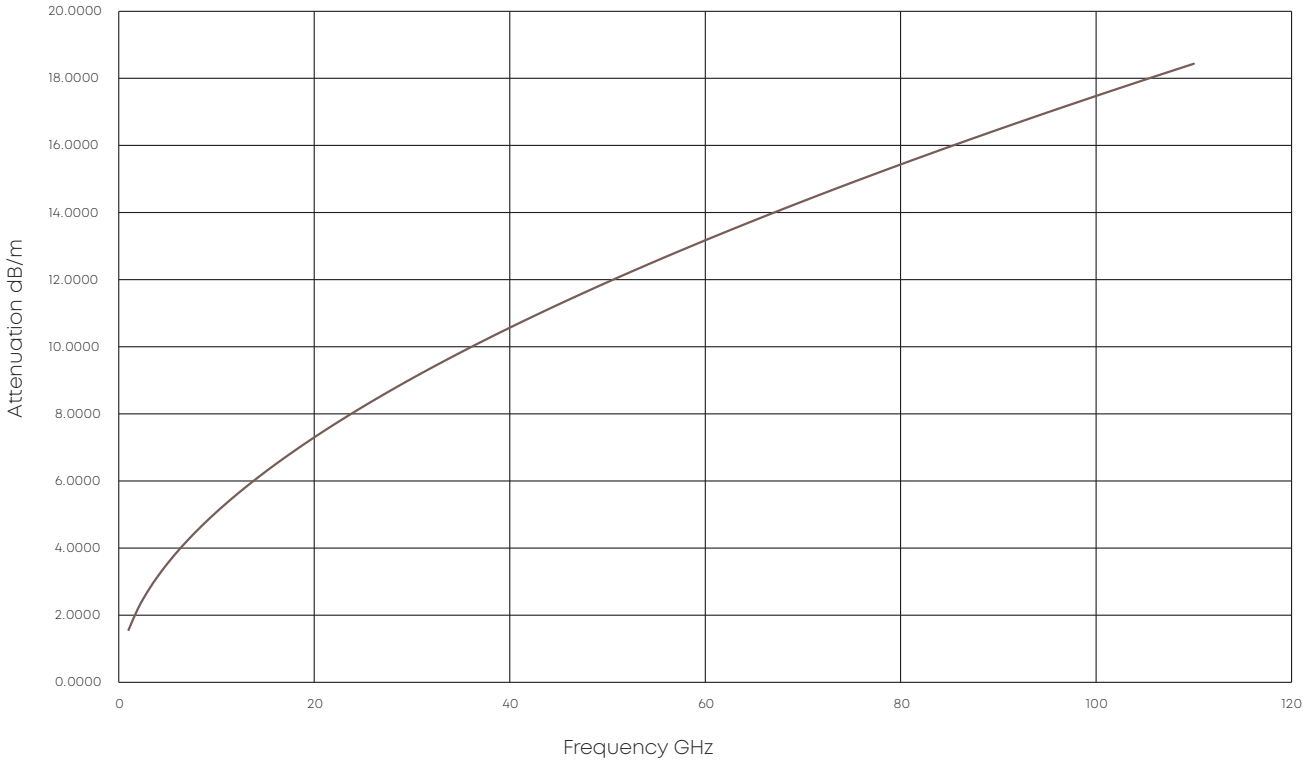

Qualifications

The entire MINIBEND family is certified to the following standards through testing, analysis or similarity.

Cable qualification

MIL-DTL-17

Connector qualification

MIL-PRF-39012

MIL-PRF-31031 (SMP)

Cable assembly qualification

MIL-PRF-55427

Space qualification

MIL-STD-1547

NASA EEE-INST-002

ESA 3902

ESA 3402

Thermal shock

MIL-STD-202, method 107, test condition A, 1000 cycles, with cable bent at min. bend radius

Mechanical shock

MIL-STD-202, method 213, 12 000 g peak

MIL-STD-883, method 2002, 1500 g peak

Sinusoidal vibration

MIL-STD-202, method 204, 28 g peak

Random vibration

MIL-STD-202, method 214, 46.3 g rms

MIL-STD-883, method 2026, 16.4 g rms

Acceleration

MIL-STD-883, method 2001, 3000 g peak

Moisture resistance

MIL-STD-202, method 106

Corrosion

MIL-STD-202, method 101, test condition B

32071 high power cable assemblies



The 32071 cable assembly offers incredible benefits to not only withstand extreme temperature and high altitude conditions, but also provide outstanding performance at high power levels. Based on its Fluoroloy® loaded connectors we can guarantee up to 500 W CW power at 150 °C under vacuum.

In addition, HUBER+SUHNER provides a comprehensive array of Fluoroloy® loaded panel connectors and feed-throughs for high power applications. Fluoroloy® has a higher dielectric constant (as compared to standard Teflon dielectric), but also a higher rate of thermal conductivity. This provides a more effective and efficient transfer of the heat generated at the center conductor, thus increasing the power handling capability of the connector. Fluoroloy® dielectric is available as an option on all of our connector types, should the power levels of the application require it.

32071 – high power, low loss



Product description

Boa-flex II cables utilize a microporous PTFE dielectric for low loss with minimal phase change due to temperature changes and flexure. Typical velocity is 78 % of the speed of light. All offer very low loss and are extremely stable with flexure.

Product features

- Impedance 50 Ω
- Applicable up to 14 GHz
- Low density PTFE for superior electrical performance
- Helical wrapped outer conductor for increased electrical performance
- Exceptional phase and insertion loss stability with flexure
- Excellent phase vs. temperature characteristics
- Preferred for phase matching and tracking applications

Recommended connectors

32071	TNC, N, SC
	Others available

Construction

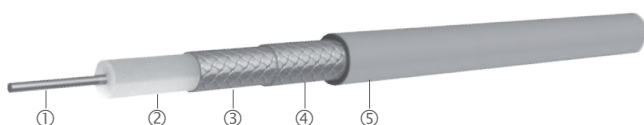

Cable	Inner conductor ①	Dielectric ②	Outer conductor ③	Outer braid ④	Jacket ⑤	Outer diameter
						mm
32071	CuAg solid	PTFE microporous	CuAg tape	CuAg	FEP, translucent amber	9.5

Technical data

Cable	Item no.	Max. operating frequency	Velocity of propagation	Weight	Min. bending radius		Temperature range
					static mm	dynamic mm	
32071	80310956	14 GHz	78 %	208.3 g/m	50.8	152.4	-55 to +200 °C

Available connectors

Connector	Series, pattern	HUBER+SUHNER type	Cable	Operating frequency	Item no.
				GHz	
TNC	straight cable plug	29614-32-71	32071	12.4	80318585
	straight high power cable plug	29614FLPV3-32-71		4.8	80378457
	straight vented cable plug	29614HTPV-32-71		12.4	80378181
N	straight cable plug	29602-32-71		12.4	80318491
	straight cable jack	29601-32-71		12.4	80318466
	straight bulkhead cable jack	29636-32-71		12.4	80340623
SC	straight cable plug	29608-32-71	10.0	80318547	

32071 – graphs

Attenuation (nominal values at +25 °C ambient temperature)

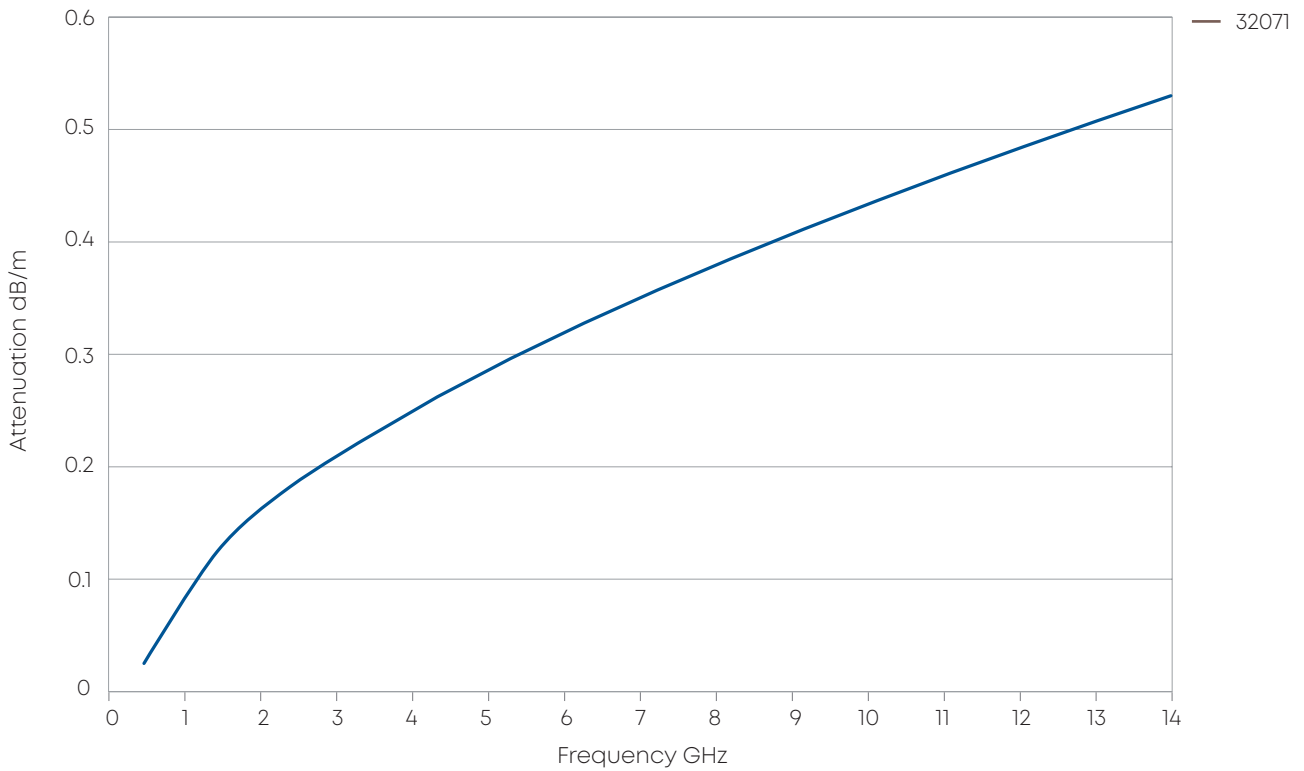

Power handling (maximum values at 25 °C ambient temperature and sea level)

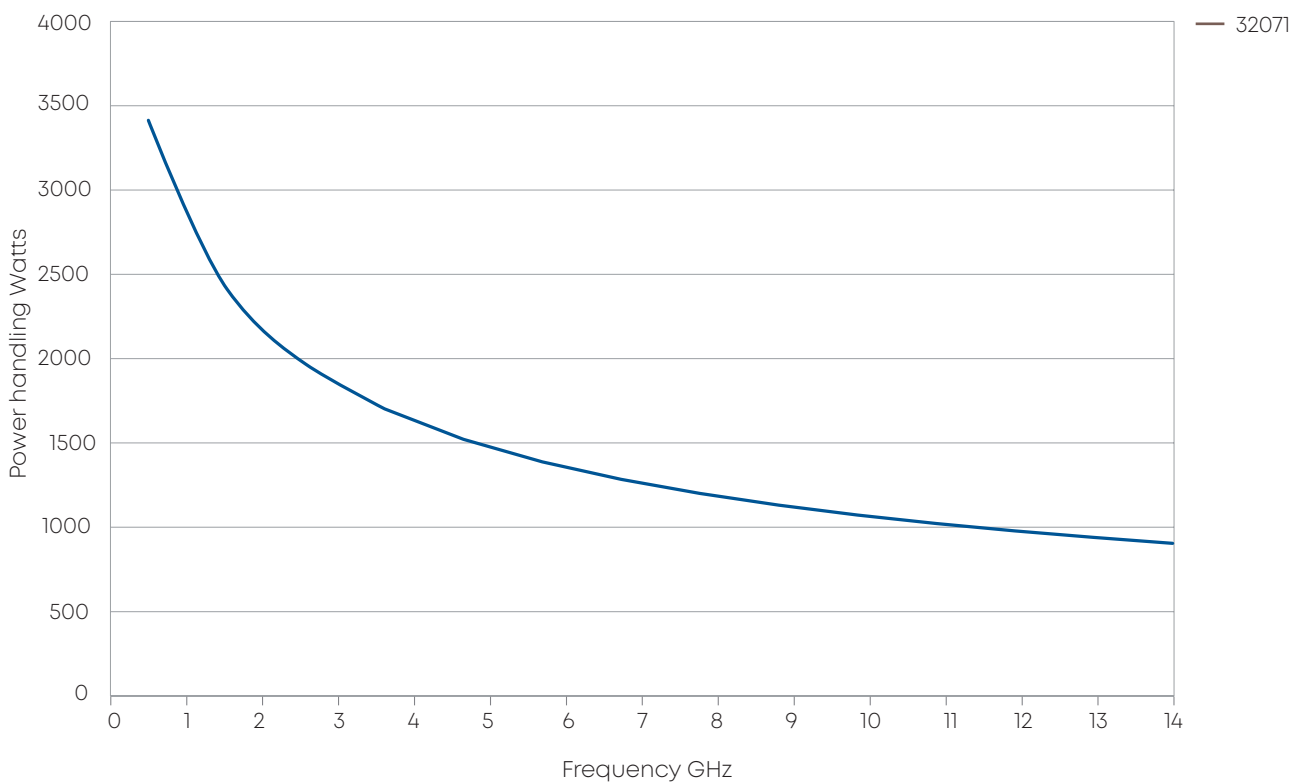

32071 – high power connectors and adaptors

29396G3-ELPV

- Hermetic TNC jack to TNC jack bulkhead adaptor
- Positively vented and pre-potted
- Frequency range up to 10 GHz
- Designed for high power and multipaction-free applications



29713-46ELPV

- Panel mount TNC jack connector
- Integrated heat sink for high power handling capability
- Positively vented and pre-potted
- Frequency range up to 14 GHz
- Designed for high power and multipaction-free applications



Eacon – field terminated microwave assembly



Eacon stands for EASY CONNECTION – a simple cable and connector solution for a flexible and fast field-termination of microwave cable assemblies without compromising high performance. The new field-terminated microwave cables and connectors are light weight and water ingress protected up to IP68 and support frequencies up to 18 GHz with a wide assortment of connector options.

Features

- Waterproof IP68
- Low loss
- Usable up to 18 GHz
- Impedance 50 Ω
- Extremely reliable
- Tool kit available

Benefits

- Easy and fast assembly – only two connector parts
- Field terminated
- Cut to length
- Narrow outer diameter for easy installation and pulling cable through bulkheads
- More added value for customers

Eacon – easy connector termination



Mounting kit

A step-by-step assembly instruction together with a complete tool set reassures a simple and quick assembly procedure.

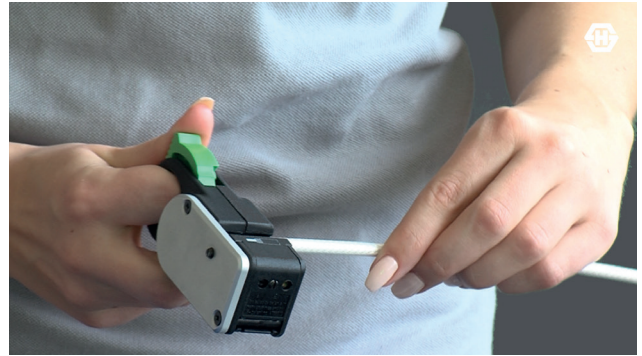

Cable preparation/stripping

The Eacon cable is prepared/stripped with a pre-aligned tool. Within 3 turns the cable is cut and ready.



Connector positioning

The cable entry is pushed onto the cable and positioned right at the end of the jacket.



Folding back the braid

Folding back the braid reassures a good retention force and a high shielding effectiveness.

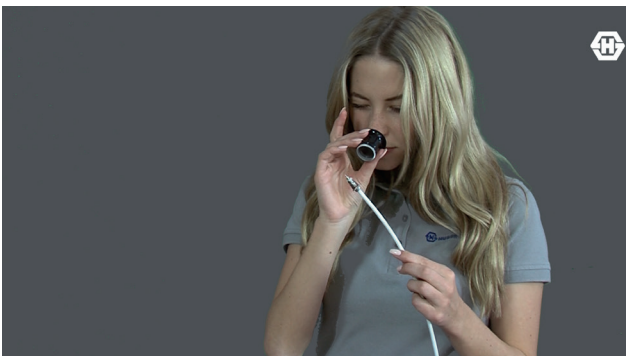

Cleaning and checking

Any foreign object debris (FOD) should be avoided on the prepared cable reassuring the specified return and insertion loss values are met.



Final assembly

The selected interface is mounted onto the prepared cable entry and tightened with a torque wrench. This ensures a high retention force and ingress protection up to IP68.

Assembly instruction video

All step-by-step instructions and the instruction video can be found on our website.



Eacon – cable types

		Eacon_2C	Eacon_4C	Eacon_6C
Cable construction				
Item no.		84116378	84048293	84116403
NATO Stock Number (NSN)			6145-17-124-813	
Max. operating frequency	GHz	18	18	18
Application		static	static	static
Velocity of propagation	%	77	77	77
Weight	g/m	35	77	150
Min. bending radius static	mm	12	16	24
Min. bending radius repeated	mm	20	25	40
Temperature range	°C	-55 to +200	-55 to +200	-55 to +200
Tensile load	N	100	180	180
Crush resistance	kN/m	8	8	8
Inner conductor		wire	wire	wire
Dielectric		LD-PTFE	LD-PTFE	LD-PTFE
Outer conductor		tape/braid	tape/braid	tape/braid
Jacket		FEP, white	FEP, white	FEP, white
Outer diameter	mm	3.75	5.50	7.70
Screening effectiveness (up to 18 GHz)	dB	> 90	> 90	> 90
Phase stability vs. flexure, 360°, diameter 55 mm (2C, 4C), 85 mm (6C)	°el/GHz	< 1.2	< 1.7	< 2.0
Phase stability vs. temperature (-40 to +85 °C)	ppm	< 1500	< 1500	< 1500
Cable attenuation at 25 °C	dB/m	see graph	see graph	see graph
Power handling	watt	see graph	see graph	see graph
Smoke index		naval engineering standard 711 and ASTM-B 622-92 (140 °F for 24 hours, conditioned @ 73 °F and 50 % relative humidity)	naval engineering standard 711 and ASTM-B 622-92 (140 °F for 24 hours, conditioned @ 73 °F and 50 % relative humidity)	naval engineering standard 711 and ASTM-B 622-92 (140 °F for 24 hours, conditioned @ 73 °F and 50 % relative humidity)
Solar radiation		MIL-STD-810, method 505, procedure II	MIL-STD-810, method 505, procedure II	MIL-STD-810, method 505, procedure II
Flammability		MIL-C-87104, paragraph 4.6.4.8 FAR, Part 25, App. F	MIL-C-87104, paragraph 4.6.4.8 FAR, Part 25, App. F	MIL-C-87104, paragraph 4.6.4.8 FAR, Part 25, App. F
Chemical resistance		British Standard 3G100, Part 2, Section 3, Class A	British Standard 3G100, Part 2, Section 3, Class A	British Standard 3G100, Part 2, Section 3, Class A
Fungus		MIL-STD-810, Method 508.3	MIL-STD-810, Method 508.3	MIL-STD-810, Method 508.3
RoHS (2002/95/EC)		compliant	compliant	compliant

Additional options



D-Armour (silicon impregnated aramid free of halogen)



Colored jacket



LSFH jacket (low smoke free of halogen)

Eacon – graphs

Attenuation (nominal values at +25 °C ambient temperature)

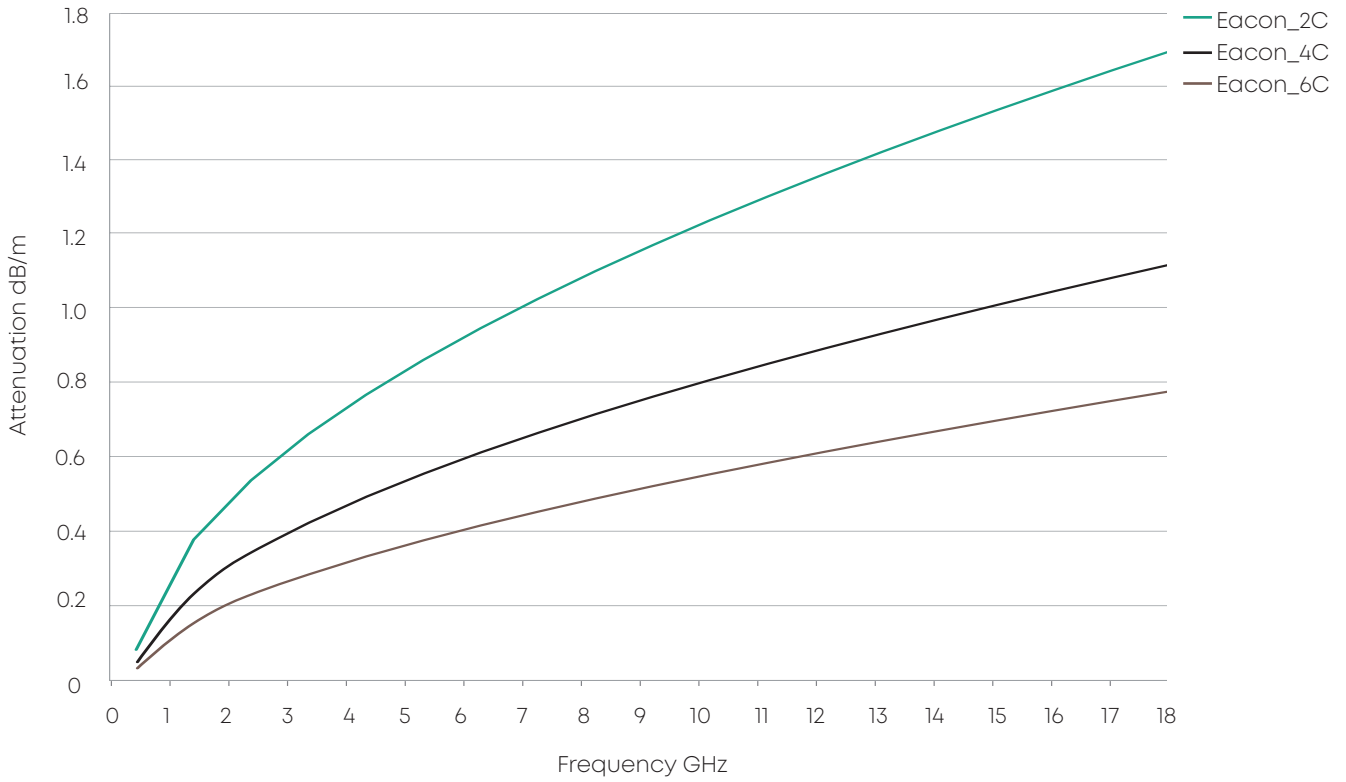

Power handling (maximum values at +25 °C ambient temperature and sea level)

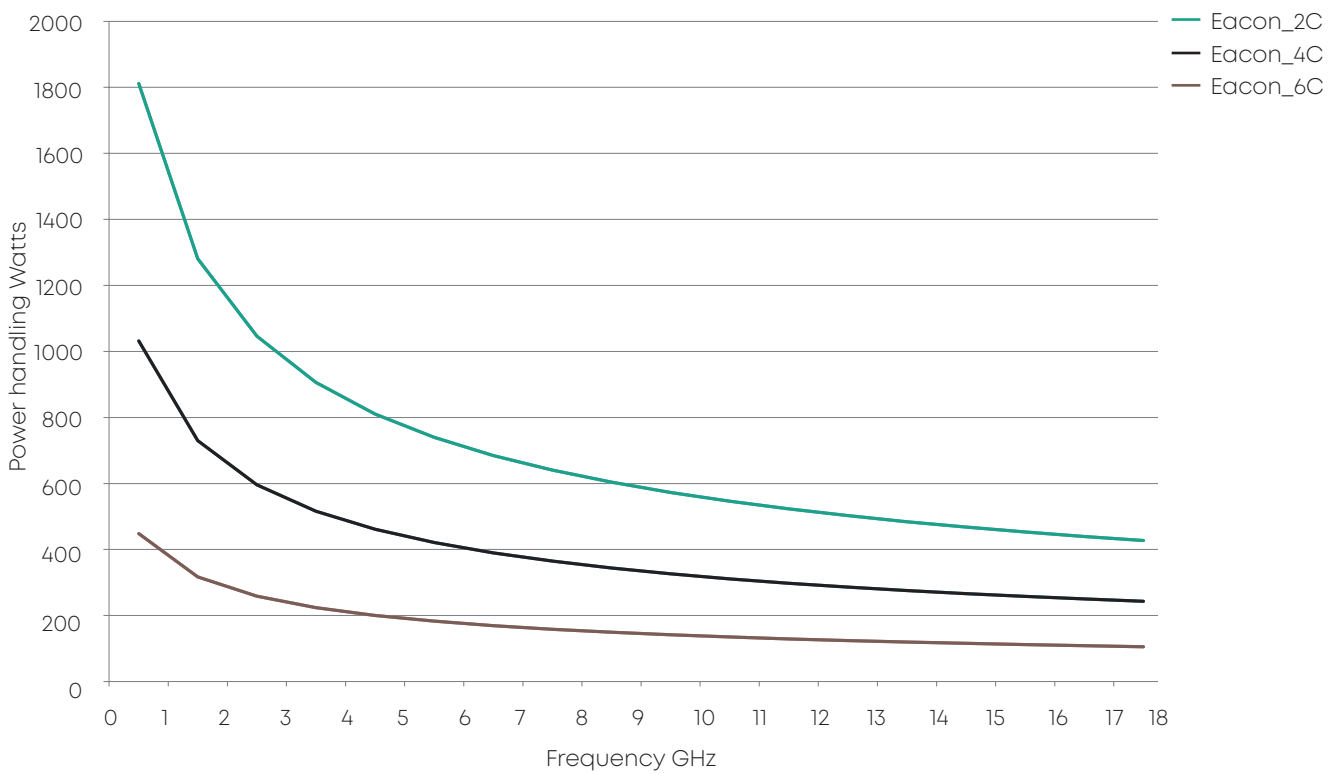

Eacon – available connector types

Connector	Series, pattern	HUBER+SUHNER type	NATO Stock Numbers (NSN)	Item no.	Eacon_2C	Eacon_4C	Eacon_6C	Typical VSWR			
								4 GHz	6 GHz	11 GHz	18 GHz
BNC	Straight cable plug	11_BNC-50-4-33/12-_NE	5935-17-124-8139	84139633	.			1.15			
	Right angle cable plug	16_BNC-50-4-14/12-_NE	5935-17-124-8140	84146122	.			1.30			
	Straight cable plug	11_BNC-50-6-83/12-_NE		85077736		.		1.15			
	Right angle cable plug	16_BNC-50-6-3/12-_NE		85077740		.		1.30			
	Straight cable jack	21_BNC-50-6-5/12-_NE		85077745		.		1.15			
	Bulkhead cable jack	24_BNC-50-6-1/12-_NE		85077750		.		1.15			
N	Straight cable plug	11_N-50-4-19/12-_NE	5935-17-124-8142	84070286	.			1.12	1.35	1.40	
	Straight cable plug	11_N-50- 6-19/12-_NE		85074230		.		1.12	1.15		
	Right angle cable plug	16_N-50-4-13/12-_NE	5935-17-124-8143	84070287	.			1.12	1.15	1.25*	
	Right angle cable plug	16_N-50- 6-14/12-_NE		85074231		.		1.18	1.25		
	Straight cable jack	21_N-50-6-7/12-_NE		85077747		.		1.12	1.15		
	Bulkhead cable jack	24_N-50-4-13/12-_NE		85005806	.			1.12		1.17	
	Bulkhead cable jack	24_N-50-6-3/12-_NE		85077425		.		1.12	1.15		
	Straight panel cable jack, flange mount	25_N-50-4-8/122_NE	5935-17-124-8144	84070288	.			1.12		1.17	
QMA	Straight cable plug	11_QMA-W50-4-4/19-_NE		84121825	.			1.12			
SMA	Straight cable plug	11_SMA-50-2-76/199_NE		85074234	.			1.13		1.30	
	Straight cable plug	11_SMA-50-4-101/199_NE	5935-17-124-8145	84070289	.			1.12		1.15	
	Straight cable plug	11_SMA-50-6-2/12-_NE		85077738		.		1.12	1.25	1.35	
	Right angle cable plug	16_SMA-50-2-20/199_NE		85074235	.			1.12	1.35		
	Right angle cable plug	16_SMA-50-4-165/199_NE	5935-17-124-8147	84070290	.			1.12	1.45		
	Right angle cable plug	16_SMA-50-6-1/12-_NE		85077744		.		1.18	1.35	1.40	
	Straight cable jack	21_SMA-50-6-1/12-_NE		85077748		.		1.12	1.25	1.35	
TNC	Straight cable plug	11_TNC-50-4-23/12-_NE	5935-17-124-8148	84070283	.			1.12	1.30		
	Straight cable plug	11_TNC-50-6-8/12-_NE		85074232		.		1.09	1.22		
	Right angle cable plug	16_TNC-50-4-101/12-_NE	5935-17-124-8149	84070284	.			1.12	1.30		
	Right angle cable plug	16_TNC-50-6-12/12-_NE		85074233		.		1.17	1.35		
	Bulkhead cable jack	24_TNC-50-6-3/12-_NE		85077423		.		1.12	1.22		
	Straight panel cable jack, flange mount	25_TNC-50-4-18/12-_NE	5935-17-124-8150	84070285	.			1.12	1.20		
	Straight cable jack	21_TNC-50-6-4/12-_NE		85077749		.		1.12	1.22		
C	Straight cable plug	11_C-50-6-2/12-_NE		85077737		.		1.12	1.25		
	Right angle cable plug	16_C-50-6-2/12-_NE		85077743		.		1.18	1.35		
SC	Straight cable plug	11_SC-50-6-1/12-_NE		80392483		.		.	.		
	Right angle cable plug	16_SC-50-6-1/12-_NE		80392484		.		.	.		
	Bulkhead cable jack	24_SC-50-6-1/12-_NE		80392485		.		.	.		
HN	Straight cable plug	11_HN-50-6-1/12-_NE		80392480		.	.				
	Right angle cable plug	16_HN-50-6-1/12-_NE		80392481		.	.				
	Bulkhead cable jack	24_HN-50-6-1/12-_NE		80392482		.	.				

*(up to 15 GHz)

Eacon – tool kits



Assembly tool kits for all connectors, used with Eacon 2C/4C/6C cables (with additional space for other auxiliary tools and spare parts).

Combined Eacon 2C/4C/6C assembly tool kit

HUBER+SUHNER type	Item no.	Content	Size
74_Z-0-0-647	85075222	all tools, needed to assemble Eacon 2C/4C/6C	395 × 315 × 100 mm/15.5 × 12.4 × 3.9 in.

Eacon 2C assembly tool kit

HUBER+SUHNER type	Item no.	Content	Size
74_Z-0-0-645	85075220	all tools, needed to assemble Eacon 2C	395 × 315 × 100 mm/15.5 × 12.4 × 3.9 in.

Pos.	HUBER+SUHNER type	Item no.	Description	Comment
1	74_Z-0-0-12	22642718	metal saw	–
2	74_Z-0-0-13	22644241	replacement of saw blade	please order separately (not incl. in the toolbox)
3	74_Z-0-0-475	84079191	torque wrench 8 mm (4 Nm)	please check the torque from time to time
4	74_Z-0-0-474	84078907	trim tool	–
5	74_Z-0-0-638	85075218	stripping tool Eacon 2C	–
6	74_Z-0-0-563	84079618	blades cartridge for stripping tool 74_Z-0-0-638	please order separately (not incl. in the toolbox)
7	74_Z-0-0-639	85075217	cone	5 pcs.
8	74_Z-0-0-641	85075213	fixation tool for cutting	–

Eacon 4C assembly tool kit

HUBER+SUHNER type	Item no.	Content	Size
74_Z-0-0-606	84074447	all tools, needed to assemble Eacon 4C	395 × 315 × 100 mm/15.5 × 12.4 × 3.9 in.

Pos.	HUBER+SUHNER type	Item no.	Description	Comment
1	74_Z-0-0-12	22642718	metal saw	–
2	74_Z-0-0-13	22644241	replacement of saw blade	please order separately (not incl. in the toolbox)
3	74_Z-0-0-475	84079191	torque wrench 8 mm (4 Nm)	please check the torque from time to time
4	74_Z-0-0-474	84078907	trim tool	–
5	74_Z-0-0-473	84079184	stripping tool Eacon 4C	–
6	74_Z-0-0-563	84079618	blades cartridge for stripping tool 74_Z-0-0-473	please order separately (not incl. in the toolbox)
7	74_Z-0-0-642	85075214	fixation tool for cutting	–

Eacon 6C assembly tool kit

HUBER+SUHNER type	Item no.	Content	Size
74_Z-0-0-646	85075221	all tools, needed to assemble Eacon 6C	395 × 315 × 100 mm/15.5 × 12.4 × 3.9 in.

Pos.	HUBER+SUHNER type	Item no.	Description	Comment
1	74_Z-0-0-12	22642718	metal saw	–
2	74_Z-0-0-13	22644241	replacement of saw blade	please order separately (not incl. in the toolbox)
3	74_Z-0-0-480	84079190	torque wrench 12 mm (5 Nm)	please check the torque from time to time
4	74_Z-0-0-474	84078907	trim tool	–
5	74_Z-0-0-640	85075219	stripping tool Eacon 6C	–
6	74_Z-0-0-564	84079619	blades cartridge for stripping tool 74_Z-0-0-640	please order separately (not incl. in the toolbox)
7	74_Z-0-0-643	85075215	fixation tool for cutting	–

High flex cables





High flex cable assemblies have repeatedly endured 1 000 000 flexure cycles with minimal electrical and mechanical degradation. All incorporate a flat wire outer conductor and a microporous dielectric for low loss and a tight woven stainless steel outer braid for improved resistance to crushing, bending and kinking. All cables were designed for use in ultra-durable, high flexure applications such as gimbale radars, antennas and installations where the cable assembly must endure multiple tight bends.

Main benefits

- Excellent flex properties
- Low resistance to movement
- High-shielding effectiveness

Waiver: While the information presented has been carefully compiled to the best of our present knowledge, it is not recommended to design-in such a product before checking with our specialists. High flex applications are very unique and driven by extreme mechanical requirements. Therefore, our specialists will support you in choosing the correct parameters to make your application a success from the beginning. Please contact our local sales organization for further information on our products.

High flex cables

	Multiflex 53	Astrolab 32094	Everflex 32084
			
Flexure	> 50 000	> 200 000	> 1 million
Operating frequency (cable)	100 GHz	27 GHz	40 GHz
Velocity of propagation	70 %	77 %	76 %
Impedance	50 Ω	50 Ω	50 Ω
Outer diameter	1.74 mm	5.3 mm	2.2 mm
Weight (g/m)	10 g/m (0.67 lbs/100 ft)	61 g/m (4.1 lbs/100 ft)	11 g/m (0.70 lbs/100 ft)
Interfaces	SSMA, SMA, SK (2.9 mm), MMPX	SMA, TNC, N, 3.5 mm, 7 mm	SMA, SSMA, 2.9 mm, SMP, 2.4 mm
Temperature range	-55 to +125 °C	-65 to +200 °C	-65 to +200 °C

Attenuation (nominal values at +25 °C ambient temperature)

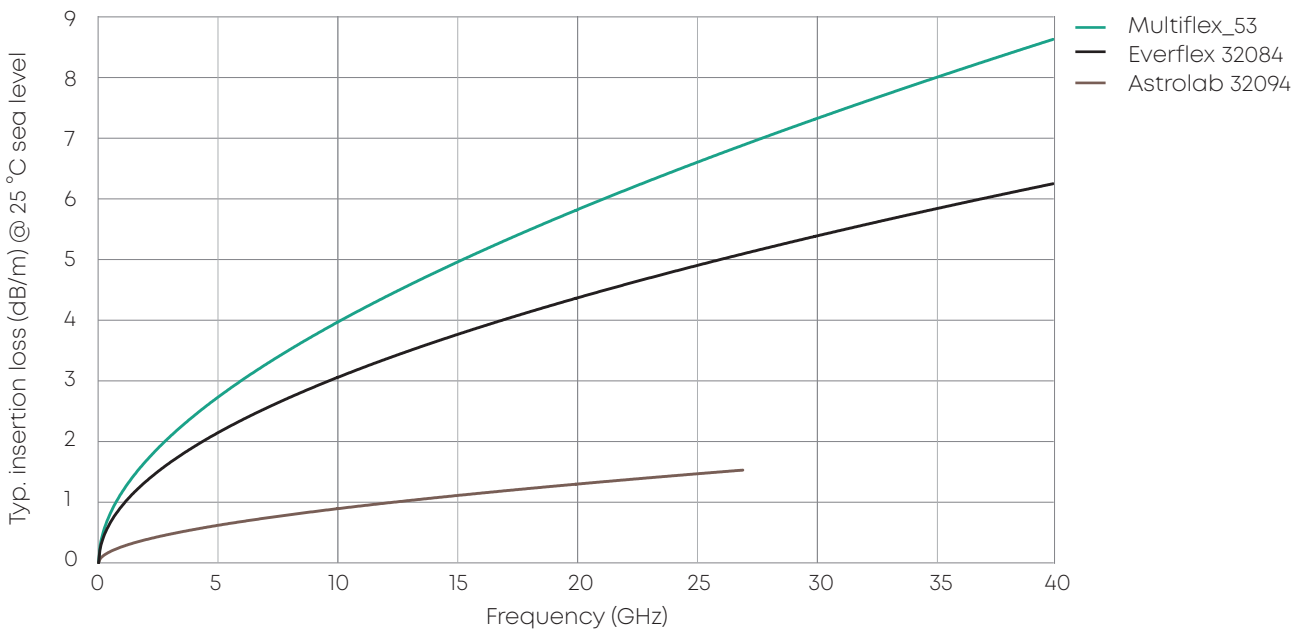

Multiport



In most modern applications restricted space requires high packing density and reduced weight, while data rates increase and rigorous safety standards require the highest quality and reliability. Multiport solutions offer unequaled advantages – especially in the field and under rough environmental conditions.

- One stop for low frequency, high frequency and fiber optic Multiport solutions
- „Plug & play“ for durable and reliable connectivity solutions
- Space saving and easy to install
- Reduces mounting time and increases system reliability

Multiport connectors MIL-DTL-38999, series III

- Spring RF contact – vibration resistant including high frequency range of DC – 18 GHz
- Qualified BMA blind mate coaxial contact – interface according to MIL-STD-348/321
- Easy mounting to meet IP68 sealing requirements with a quick screw coupling connector
- Different coding schemes to avoid reverse polarization issues
- Excellent crosstalk performance between channels
- High performance microwave connection based on SUCOFLEX® and Multiflex microwave cable assemblies

Multiport



Custom specific design

Multiport solutions are specifically designed according to your requirements. Each solution is unique and a vast portfolio of connectors with different styles and codings, earthing shells, shielding braids, rugged outer jackets and breakouts are available:

- Multiport connector/backshells: standard aluminum, composite, titanium, stainless steel and bronze
- Connector style: jamnut receptacle, square flange receptacle, plug
- Additional braids, jackets, breakouts, armors available
- Size 8 insert designed-in for BMA connectors acc. MIL-STD-348/321
- Other size inserts (size 12, 16, 20) on request

Harsh environment proved design

- IP68 sealed solutions
- Salt spray: MIL-STD-1344 (48 to 2000 hours)
- Connector endurance: min. 500 cycles

BMA contacts

Electrical features	
Impedance	50 Ω
Frequency range	DC – 18 GHz
Dielectric withstanding voltage	1.5 kVrms, 50 Hz (at sea level)
Insulation resistance	≥ 5000 M Ω
Contact resistance	center contact: ≤ 2 m Ω outer contact: ≤ 2 m Ω
VSWR (typical values – DC 18GHz)	$\leq 1.02 + 0.005 f$ (GHz) mated connector
Average power (at sea level and room temperature)	< 250 Watt, @ 3 GHz, < 220 Watt, @ 6 GHz < 180 Watt, @ 10 GHz, < 120 Watt, @ 18 GHz
RF leakage interface only (fully mated)	≥ 90 dB f (GHz)
Climatic features	
Temperature range	-65 to +175 °C
Thermal shock	MIL-STD-202, method 107, condition B
Resistance to moisture	MIL-STD-202, method 106
Resistance to fluid	gasoline, mineral and synthetic hydraulic fluid, mineral and synthetic lubrication, cleaning and de-icing fluid, extinguishing and cooling fluid.
Corrosion	MIL-STD-202, method 101, condition B
Vibration	MIL-STD-202, method 204, condition D
Shock	MIL-STD-202, method 213, condition I

High performance microwave solution based on SUCOFLEX® and Multiflex microwave cable assemblies. Check the cable selection guide in the back of this catalog for further details on available cable types.

RF cables



HUBER+SUHNER offers a broad assortment of coaxial cables, developed to meet the highest standards. A wide range of flexible coaxial cables provides the best performance for demanding applications. Our premium quality cables have excellent electrical and mechanical properties and are used globally in various applications to meet the highest demands. Comprehensive, professional support in conjunction with our comprehensive product range makes HUBER+SUHNER a leading provider of radio frequency solutions in defense applications.

RG/Enviroflex

- Temperature range
- High performance
- RG standard

Spuma series

- High precision
- Excellent shielding
- Halogen-free options

Further informations

[External document](#) 

RG/Enviroflex/Spuma series

RG/Enviroflex series



The PTFE/FEP cables from our RG series are designed for applications up to 200 °C and are characterized by low loss, especially at high frequencies. The cables in the HUBER+SUHNER Enviroflex family do not contain fluorine plastics in the dielectric or in the jacket and thus provide a robust and environmentally friendly option

	RG	Enviroflex
Dielectric material	PTFE	SPEX
Jacket material	FEP	RADOX®
Halogen free	–	✓
Low smoke	✓	✓
Flame retardancy	Not flammable	✓✓
Temperature range	✓✓✓	✓✓
Weather resistance	✓✓✓	✓✓
Outer diameter (in mm)		
2	RG_178_B/U	EF_178, EF_178_D
3	RG_316_U	EF_316, EF_316_D
5	RG_400_U	EF_400
5	RG_142_B/U	EF_142
10	RG_393_U	EF_393

Spuma series



The Spuma family provides the lowest attenuation, high flexibility and optimal shielding. The LSFH jacket material offer extremely high flame protection, whereas the Spuma-HT line offers great loss performance at an extended temperature range of up to 150 °C.

	Spuma	Spuma-FR	Spuma-UF	Spuma-HT
Dielectric material	SPE	SPE	SPE	PTFE
Jacket material	PE	LSFH	TPU	FEP
Halogen free	✓	✓	–	–
Low smoke	–	✓	–	–
Flame retardancy	–	✓✓	–	not flammable
Temperature range	✓	✓	✓	✓✓✓
Weather resistance	✓✓	✓✓	✓✓	✓✓✓
Outer diameter (in mm)				
5	Spuma_195	Spuma_195-FR-01	–	–
6	Spuma_240	Spuma_240-FR-01	Spuma_240-UF	Spuma_240-HT
10	Spuma_400	Spuma_400-FR-01	Spuma_400-UF	Spuma_400-HT
13	–	Spuma_500-FR-01	–	–
15	Spuma_600	–	–	Spuma_600-HT

RG/Enviroflex/Spuma series

RG series

Cable type	Item no.	Impedance (Ω)	Freq. (GHz)	Inner conductor	Dielectric	Braid construction	Jacket	Diameter (mm)
RG_178_B/U	22510043	50	1	strand-07	PTFE	single screen	FEP	1.80
RG_316_/U	22510079	50	3	strand-07	PTFE	single screen	FEP	2.50
RG_400_/U	22510080	50	6	strand-19	PTFE	double screen	FEP	4.95
RG_142_B/U	22510037	50	6	wire	PTFE	double screen	FEP	4.95
RG_393_/U	22511430	50	6	strand-07	PFA	double screen	FEP	9.90

Enviroflex series

Cable type	Item no.	Impedance (Ω)	Freq. (GHz)	Inner conductor	Dielectric	Braid construction	Jacket	Diameter (mm)
Enviroflex_178	23010656	50	3	strand-07	SPEX*	single screen	RADOX®	1.84
Enviroflex_178_D	23030426	50	6	strand-07	SPEX*	double screen	RADOX®	2.45
Enviroflex_316	23009565	50	3	strand-07	SPEX*	single screen	RADOX®	2.54
Enviroflex_316_D	22512281	50	6	strand-07	SPEX*	double screen	RADOX®	3.16
Enviroflex_400	22512280	50	6	strand-19	SPEX*	double screen	RADOX®	5.00
Enviroflex_142	22512168	50	6	wire	SPEX*	double screen	RADOX®	5.00
Enviroflex_393	22512282	50	6	strand-07	SPEX*	double screen	RADOX®	10.05

Spuma series

Cable type	Item no.	Impedance (Ω)	Freq. (GHz)	Inner conductor	Dielectric	Braid construction	Jacket	Diameter (mm)
Spuma_195	84151727	50	6	wire	SPE**	tape/braid	PE	4.95
Spuma_195-FR-01	85021562	50	6	wire	SPE**	tape/braid	LSFH	4.95
Spuma_240	84151737	50	6	wire	SPE**	tape/braid	PE	6.15
Spuma_240-FR-01	85021563	50	6	wire	SPE**	tape/braid	LSFH	6.15
Spuma_240-UF	84318337	50	3	strand-07	SPE**	tape/braid	TPU	6.17
Spuma_240-HT	85076426	50	6	wire	PTFE	tape/braid	FEP	5.21
Spuma_400	84102703	50	6	wire	SPE**	tape/braid	PE	10.25
Spuma_400-FR-01	84132035	50	6	wire	SPE**	tape/braid	LSFH	10.25
Spuma_400-FR-75	85022187	75	3	wire	SPE**	tape/braid	LSFH	10.25
Spuma_400-UF	85068966	50	3	strand-07	SPE**	tape/braid	TPU	10.25
Spuma_400-HT	85076427	50	6	wire	PTFE	tape/braid	FEP	9.40
Spuma_500-FR-01	85021564	50	6	wire	SPE**	tape/braid	LSFH	12.78
Spuma_600	84151738	50	6	wire	SPE**	tape/braid	PE	14.99
Spuma_600-HT	85076428	50	6	wire	PTFE	tape/braid	FEP	14.38

RG/Enviroflex/Spuma series

Temperature range (°C)	Attenuation @ 1 GHz (dB/m)	Attenuation @ 3 GHz (dB/m)	Attenuation @ 6 GHz (dB/m)	Screening effectiveness	Bending static (mm)	Bending repeated (mm)	Cable group
-65 to +165	1.62	-	-	> 40 dB (up to 1 GHz)	10	18	U1
-65 to +165	0.87	1.63	-	> 38 dB (up to 1 GHz)	15	25	U2
-65 to +165	0.48	0.95	1.51	> 81 dB (up to 6 GHz)	30	50	U11
-65 to +165	0.46	0.88	1.36	> 85 dB (up to 6 GHz)	30	50	U9
-65 to +165	0.3	0.69	1.20	> 81 dB (up to 6 GHz)	60	100	U33

Temperature range (°C)	Attenuation @ 1 GHz (dB/m)	Attenuation @ 3 GHz (dB/m)	Attenuation @ 6 GHz (dB/m)	Screening effectiveness	Bending static (mm)	Bending repeated (mm)	Cable group
-40 to +105	1.63	3.11	-	> 40 dB (up to 3 GHz)	5	20	U1
-40 to +105	1.63	3.08	4.72	> 60 dB (up to 6 GHz)	5	20	X1
-40 to +105	0.97	1.86	-	> 38 dB (up to 1 GHz)	5	30	U2
-40 to +105	0.89	1.75	2.77	> 80 dB (up to 6 GHz)	5	30	U4
-40 to +105	0.57	1.08	1.65	> 70 dB (up to 6 GHz)	10	40	U11
-40 to +105	0.54	1.07	1.7	> 75 dB (up to 5 GHz)	25	50	U9
-40 to +105	0.29	0.65	1.11	> 78 dB (up to 3 GHz)	30	100	U33

Temperature range (°C)	Attenuation @ 1 GHz (dB/m)	Attenuation @ 3 GHz (dB/m)	Attenuation @ 6 GHz (dB/m)	Screening effectiveness	Bending static (mm)	Bending repeated (mm)	Cable group
-40 to +85	0.39	0.69	1.00	> 90 dB (up to 6 GHz)	12.5	50	X27
-40 to +85	0.39	0.69	1.00	> 90 dB (up to 6 GHz)	12	50	X27
-40 to +85	0.26	0.47	0.68	> 90 dB (up to 6 GHz)	19	60	X28
-40 to +85	0.26	0.47	0.68	> 90 dB (up to 6 GHz)	19	63	X28
-40 to +85	0.42	0.85	-	> 90 dB (up to 3 GHz)	14	53	X34
-55 to +150	0.28	0.50	0.74	> 90 dB (up to 6 GHz)	25	50	-
-40 to +85	0.13	0.24	0.35	> 90 dB (up to 6 GHz)	25	100	U30
-40 to +85	0.13	0.24	0.35	> 90 dB (up to 6 GHz)	25	100	U30
-40 to +85	0.14	0.25	-	> 90 dB (up to 3 GHz)	25	100	X33
-40 to +85	0.17	0.30	-	> 90 dB (up to 3 GHz)	25	100	X34
-55 to +150	0.14	0.27	0.40	> 90 dB (up to 6 GHz)	44	101	-
-40 to +85	0.10	0.19	0.29	> 90 dB (up to 6 GHz)	31	127	X31
-40 to +85	0.09	0.16	0.24	> 90 dB (up to 6 GHz)	38	152	X29
-55 to +150	0.10	0.17	0.25	> 90 dB (up to 6 GHz)	44	101	X37

RG/Enviroflex series – graphs

Attenuation (nominal values at +25 °C ambient temperature)

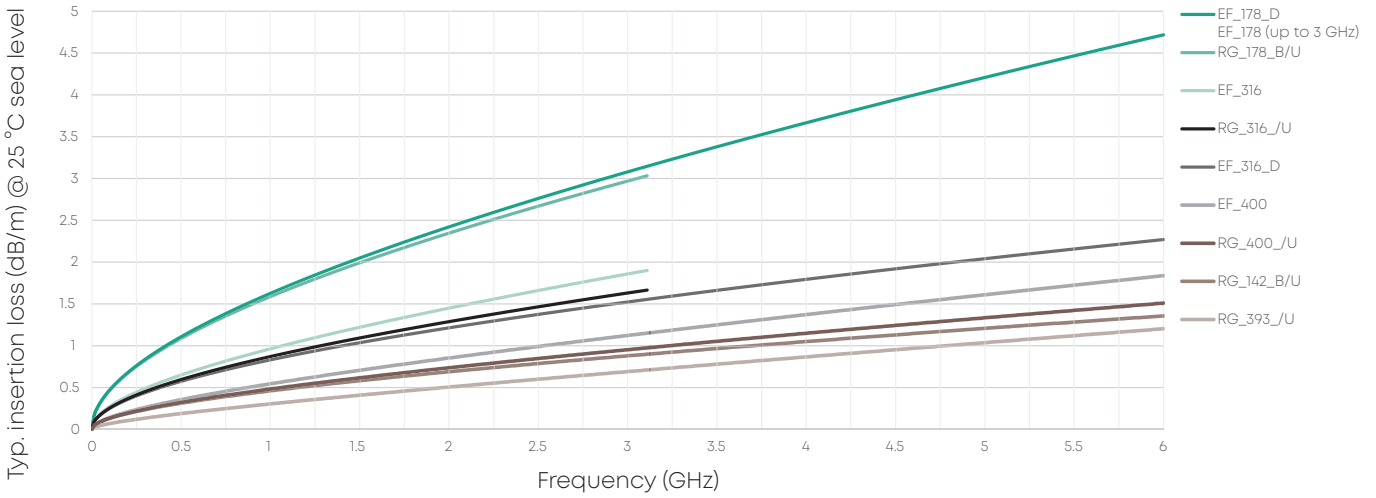

Power handling (maximum values at 25 °C ambient temperature and sea level)

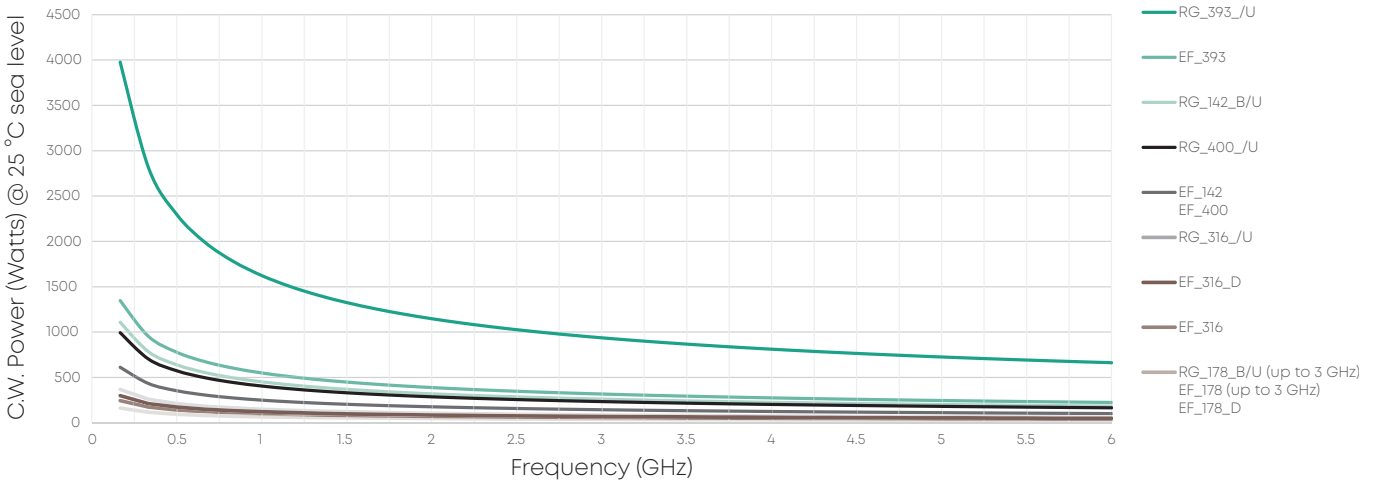

Connector availability

Interfaces	cable group	SMA				TNC				N				BNC				QN				QMA			
		male straight	male right angle	female straight	female bulkhead	male straight	male right angle	female straight	female bulkhead	male straight	male right angle	female straight	female bulkhead	male straight	male right angle	female straight	female bulkhead	male straight	male right angle	female straight	female bulkhead	male straight	male right angle	female straight	female bulkhead
RG_178_B/U	U1
RG_316_U	U2
RG_400_U	U11
RG_142_B/U	U9
RG_393_U	U33
EF_178	U1
EF_178_D	X1
EF_316	U2
EF_316_D	U4
EF_400	U11
EF_142	U9
EF_393	U33

Spuma series – graphs

Attenuation (nominal values at +25 °C ambient temperature)

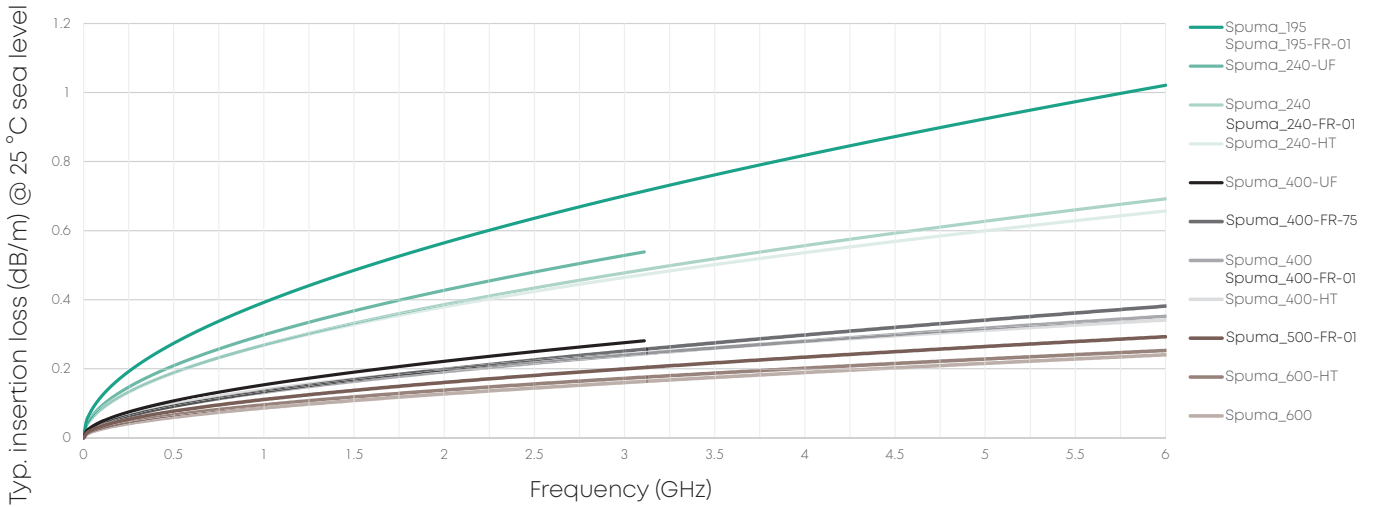

Power handling (maximum values at 25 °C ambient temperature and sea level)

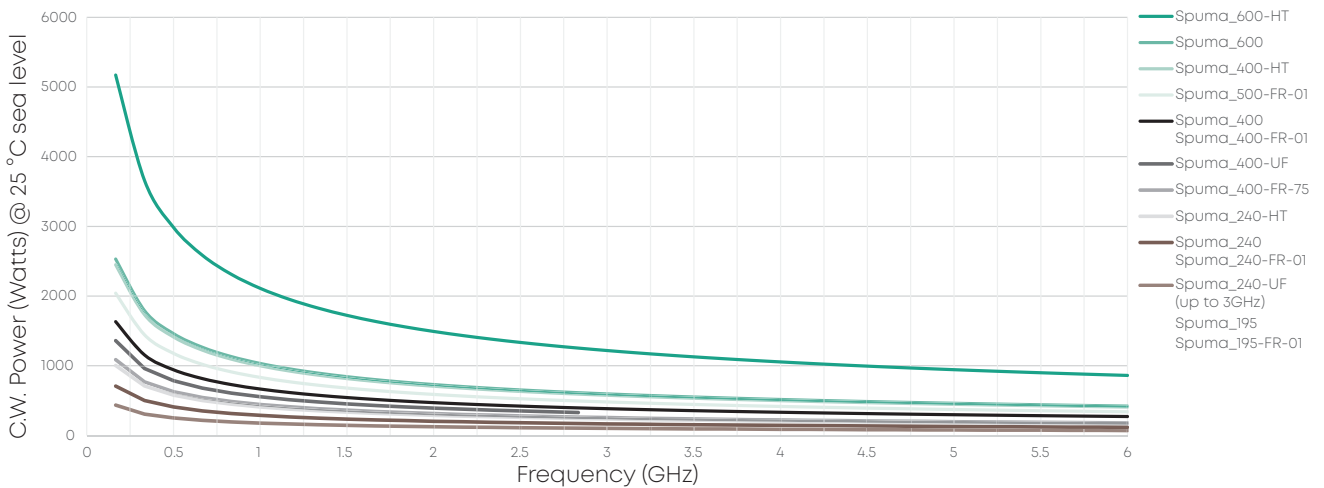

Connector availability

Interfaces	cable group	SMA				TNC				N				BNC				QN				QMA			
		male straight	male right angle	female straight	female bulkhead	male straight	male right angle	female straight	female bulkhead	male straight	male right angle	female straight	female bulkhead	male straight	male right angle	female straight	female bulkhead	male straight	male right angle	female straight	female bulkhead	male straight	male right angle	female straight	female bulkhead
Spuma_195	X27	•	•			•	•			•	•														
Spuma_195-FR-01	X27	•	•			•	•			•	•														
Spuma_240	X28	•	•	•		•	•	•	•	•	•	•	•	•	•		•	•	•	•	•	•	•		•
Spuma_240-FR-01	X28	•	•	•		•	•	•	•	•	•	•	•	•	•		•	•	•	•	•	•	•		•
Spuma_400	U30	•	•			•	•	•	•	•	•	•	•	•	•			•	•			•	•		
Spuma_400-FR-01	U30	•	•			•	•	•	•	•	•	•	•	•	•			•	•			•	•		
Spuma_400-FR-75	X33																•								
Spuma_500-FR-01	X31									•	•	•													
Spuma_600	X29									•	•														

LSFH cables



The need for low smoke free of halogen cables and cable assemblies is driven by an increasing awareness of the industry to prevent toxic fume ingestion in the event of a fire. Especially in applications where space is limited or a fast evacuation is impossible, low smoke free of halogen cables are a must.

HUBER+SUHNER offers a broad range of cables. Our RADOX® and LSFH materials meet truly challenging flammability and smoke density requirements.

- RADOX® – increased temperature range, resistance against oil, chemicals and UV
- Ultra low loss
- Good flexibility, low bending moment
- Extended frequency range up to 46 GHz

LSFH series

LSFH cables

Cable type	Item no.	Impedance (Ω)	Frequency (GHz)	Diameter (mm)	Temperature range (°C)	Halogen free IEC 60754-1/-2	Flammability
Enviroflex_178	23010656	50	3	1.84	-40 to +105	✓	✓
Enviroflex_178_D	23030426	50	6	2.45	-40 to +105	✓	✓
Enviroflex_316	23009565	50	3	2.54	-40 to +105	✓	✓
Enviroflex_316_D	22512281	50	6	3.16	-40 to +105	✓	✓
Enviroflex_400	22512280	50	6	5.00	-40 to +105	✓	✓
Enviroflex_142	22512168	50	6	5.00	-40 to +105	✓	✓
Enviroflex_393	22512282	50	6	10.05	-40 to +105	✓	✓
Spuma_195-FR-01	85021562	50	6	4.95	-40 to +85	✓	✓
Spuma_240-FR-01	85021563	50	6	6.15	-40 to +85	✓	✓
Spuma_400-FR-01	84132035	50	6		-40 to +85	✓	✓
Spuma_400-FR-75	85022187	75	3	10.25	-40 to +85	✓	✓
Spuma_500-FR- 01	85021564	50	6	12.75	-40 to +85	✓	✓
Sucoform_86_LSFH	22512147	50	40	3.20	-40 to +85	jacket only	UL 1581 § 1100 IEC 60332-2
Sucoform_141_LSFH	22512148	50	33	4.60	-40 to +85	jacket only	UL 1581 § 1100 IEC 60332-2
Eacon_6CI-010	84145046	50	18	8.20	-40 to +85	jacket only	UL 1581 § 1100 IEC 60332-2

LSFH Microwave cable assemblies

Cable type	Item no.	Impedance (Ω)	Frequency (GHz)	Diameter (mm)	Temperature range (°C)	Halogen free IEC 60754-1/-2	Flammability
SUCOFLEX_102_I	-	50	46	4	-40 to +85	jacket only	IEC 60332-1
SUCOFLEX_103_I	-	50	33	4.8	-40 to +85	jacket only	IEC 60332-1
SUCOFLEX_104_I	-	50	26.5	6.6	-40 to +85	jacket only	IEC 60332-1
SUCOFLEX_106_I	-	50	18	8.4	-40 to +85	jacket only	IEC 60332-1
SUCOFLEX_118_I	-	50	18	8.4	-40 to +85	jacket only	IEC 60332-1

RF connectors and adaptors

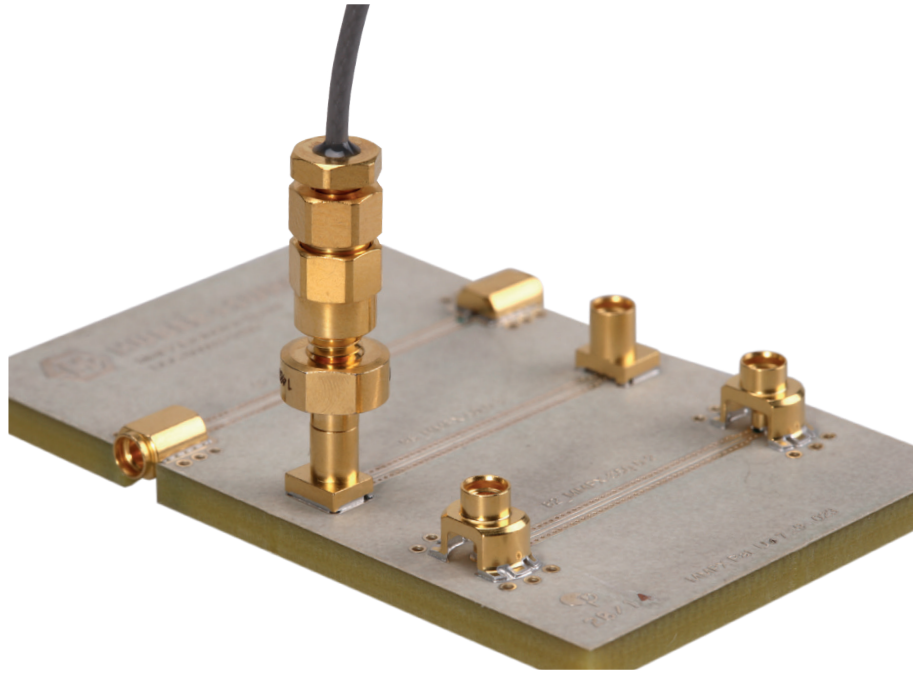

HUBER+SUHNER is a leading global provider of RF connectors, adapters and resistive components. We offer a wide range of standard connectors and application specific solutions. With our experience, product knowledge and application know-how we support customers with application specific solutions.

Within the standard connector series of SMP, SMPM, SMPM-T, MXP, SMA, BNC, TNC, N and others, we provide a comprehensive range of connectors for different applications.

We constantly refine our product portfolio with new and innovative solutions. HUBER+SUHNER has established market standards with board-to-board connectivity solutions such as MMBX and MBX and with connectors with quick-lock mating mechanisms like QMA, XQMA, QN, and XQN.

Additionally HUBER+SUHNER supports its customers worldwide with application engineers to assist customers in production selection. The success of HUBER+SUHNER can be attributed to our high quality products, design-in support and expertise in RF Technology. We are your partner for RF connectivity solutions.

Please find more product details in our RF coaxial connectors catalog.

Further informations

External document 

RF connectors and adaptors

Series	Coupling mechanism	Frequency range	Picture
BNC	bayonet	4 GHz	
MBX	slide-on	6 GHz	
MCX	snap-on	6 GHz	
MMCX	snap-on	6 GHz	
7/16	screw-on	7.5 GHz	
C	screw-on	11 GHz	
TNC	screw-on	11 GHz	
QN XQN	quick-lock – waterproof IP68 quick-lock – salt and ice protection	11 GHz	
4.3-10	screw-on/snap-on	12 GHz	
MMBX	snap-on	15 GHz	
N	screw-on	18 GHz	
QMA XQMA	quick-lock	18 GHz	
BMA	slide-on	18 GHz/26.5 GHz	
SMA	screw-on (intermateable with PC3.5 and SK)	18 GHz/26.5 GHz	
PC 3.5 (3.5 mm)	screw-on (intermateable with SMA and SK)	26.5 GHz	
SK (2.92 mm)	screw-on (intermateable with PC3.5 and SMA)	40 GHz	
SSMA	screw-on	40 GHz	
SMP	snap-on	40 GHz	
Self-locking connectors	screw-on	up to 40 GHz	
PC 2.4 (2.4 mm)	screw-on	50 GHz	
PC 1.85 (1.85 mm)	screw-on	67 GHz	
SMPM/SMPM-T	snap-on/screw-on	67 GHz	
VITA 67	slide-on	67 GHz	

Board-to-board connectors

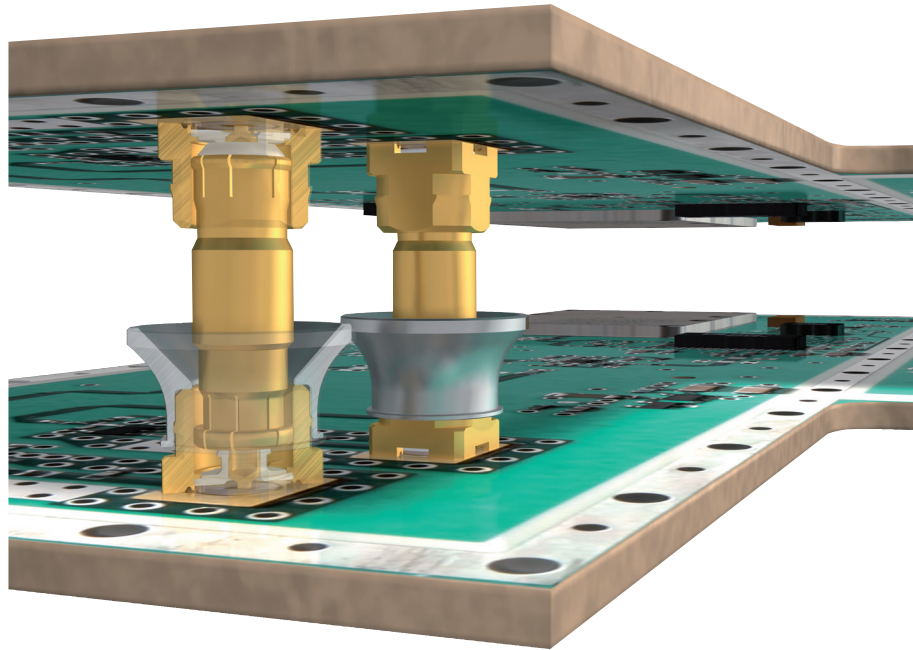

Lower cost

Direct board-to-board connections with compensating misalignment (**axial float ± 1.2 mm**) not only save costs compared to cable connections but also allow larger tolerances on all other components.

Miniaturization

HUBER+SUHNER board-to-board connectors provide the smallest **board-to-board distance (6.7 mm)** in class. This enables smaller designs with less weight and provide much more space on the PCB.

Reliable connection

Due to the unique **fully automated production** process and 100 % interface control highest quality requirements, capacity and flexibility can be achieved.

High output power and excellent RF performance

HUBER+SUHNER board-to-board connectors can handle very high power requirements (**260 W**) in a module environment where high ambient temperatures are a given.

This opens new possibilities for module designs

without active cooling. Thanks to the unique ball joint design the connectors provide **excellent return loss** values over the complete floating range combined with **outstanding RF shielding** performance.

Secure mating

With blind mateability and the largest connecting range in class, very fast module assemblies are possible.

MBX

- Very high axial float – best in class
- High output power
- Excellent return loss values
- Smallest board-to-board distances in class
- DC to 6 GHz



MMBX

- Very high frequencies (DC to 15 GHz)
- Very good return loss values
- Smallest board-to-board distances in class



SMPM

- Ultra high frequency range (DC to 65 GHz)
- MIL-STD-348 qualified
- Various detent options
- Custom ganged connection options available
- Smallest pitch distance and envelope
- Smallest board-to-board distances
- True 65 GHz board-to-board solution



SMP

- Ultra high frequency range (DC to 40 GHz)
- MIL-STD-348 qualified
- Various detent options
- Rugged and reliable
- Most widely used board-to-board connector in the market
- Small board-to-board distances



Applications

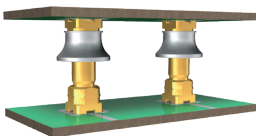

Board-to-board connection

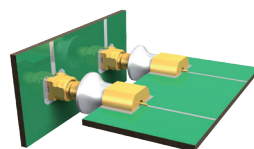

Board-to-board connection
right angle

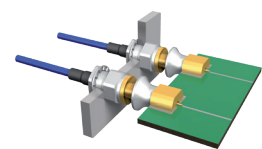

Board-to-panel connection
right angle

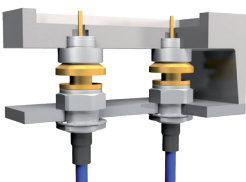

Panel-to-panel connection

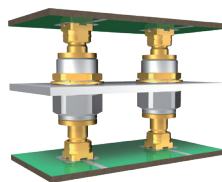

Board-to-board through a panel

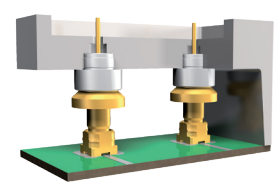

Board-to-panel connection (filter)

Technical data of MBX and MMBX B-to-B connectors

Electrical data	MBX	MMBX
	Requirements	
Impedance	50 Ω	
Frequency range	DC – 6 GHz	DC – 15 GHz
Dielectric withstanding voltage (at sea level)	1 kV rms, 50 Hz	
Working voltage (at sea level)	\leq 330 V rms, 50 Hz	
Insulation resistance	\geq 1 G Ω	
Contact resistance – center contact – outer contact	\leq 5 m Ω \leq 2.5 m Ω	\leq 5 m Ω \leq 1 m Ω
Return loss (typical values for a board-to-board connection (measured on board))	26 dB @ 2.5 GHz/19 dB @ 6 GHz	26 dB @ 2.5 GHz/25 dB @ 6 GHz
RF-leakage (interface only)	\geq 70 dB (DC – 6 GHz)	\geq 70 dB (DC – 6 GHz) \geq 60 dB (6 to 12.4 GHz)
Power	typical 240 W at 2.4 GHz at room temperature	

Mechanical data	Requirements	
Engagement force (slide-side)	\leq 15 N/3.4 lbs	
Disengagement force (slide-side)	\leq 15 N/3.4 lbs	
Durability (mating cycles)	100	
Axial float (misalignment)	\pm 1.2 mm	\pm 0.3 mm
Radial float (misalignment)	depending on the adapter \pm 0.6 mm (at 13 mm board-to-board distance) \pm 1.0 mm (\geq 18 mm board-to-board distance)	depending on the adapter \pm 0.4 mm (at 6.7 mm board-to-board distance) \pm 0.8 mm (\geq 11.65 mm board-to-board distance)

Environmental data	Test conditions	
Temperature range	–55 to +155°C / –67 to +311°F	
Climatic category	55/155/10	55/155/21
Thermal shock	MIL-STD-202, method 107 G, condition B1	
Moisture resistance	MIL-STD-202, method 106 F	
Corrosion	MIL-STD-202, method 101, condition B	
Vibration	MIL-STD-202, method 204 D, condition A	
Mechanical shock	MIL-STD-202, method 213 B, condition B	–

Processing data	Requirements	
Adherent to the print – shearing – pulling (vertical to PCB)	\geq 150 N/33.7 lbs. \geq 150 N/33.7 lbs.	

Material data MBX/MMBX		
Connector parts	Material	Plating
Center contact	brass/bronze/copper-beryllium alloy	SUCOPRO® gold plating
Outer contact	brass/bronze	SUCOPRO® gold plating
Body	brass	SUCOPRO® gold plating
Insulators	LCP/PTFE/PFA	
Funnel	brass/PA	SUCOPLATE®

Performance listed is typical. Individual part configuration may vary. Contact HUBER+SUHNER for more information and specifications.

Technical data of SMP and SMPM B-to-B connectors

Electrical data	SMP	SMPM
	Requirements	
Impedance	50 Ω	50 Ω
Frequency range	DC to 40 GHz	DC to 65 GHz
Contact resistance	center conductor 6.0 milliohms max. outer conductor 2.0 milliohms max.	center conductor 6.0 milliohms max. outer conductor 2.0 milliohms max.
DWV	500 Vrms at sea level	335 Vrms at sea level
Insulation resistance	5000 megohms min.	5000 megohms min.
Corona levels	190 Vrms at 70 000 ft	125 Vrms at 70 000 ft
RF high potential	325 Vrms at 5 MHz	200 Vrms at 5 MHz
RF leakage	80 dB max. @ 3 GHz 65 dB max. @ 3 to 26.5 GHz	80 dB max. @ 3 GHz 65 dB max. @ 3 to 26.5 GHz
Magnetic permeability	< 2 Mu	< 2 Mu
VSWR	1.20:1 to 18.0 GHz 1.35:1 to 26.5 GHz	1.1:1 to 26.5 GHz 1.3:1 to 65 GHz
Insertion loss	0.06 \sqrt{f} in GHz (non-hermetic connectors) 0.12 \sqrt{f} in GHz (hermetic connectors)	0.05 + 0.04 \sqrt{f} in GHz (non-hermetic connectors) 0.12 \sqrt{f} in GHz (hermetic connectors)

Mechanical data	Requirements	
Center contact retention	1.5 lbs (6.672 N) min. (captivated designs)	1.5 lbs (6.672 N) min. (captivated designs)
Durability	100 cycles min. into a full detent shroud 500 cycles min. into a limited detent shroud 1000 cycles min. into a smooth bore shroud	100 cycles min. into a full detent shroud 1000 cycles min. into a smooth bore shroud
Force to engage	SMP full detent – 15 lbs (66.723 N) max. SMP limited detent – 10 lbs (44.482 N) max. SMP smooth bore – 2 lbs (8.896 N) max.	SMPM full detent – 3.5 lbs (15.569 N) typical SMPM smooth bore – 1.5 lbs (6.672 N) typical
Force to disengage	SMP full detent – 5 lbs (22.241 N) min. SMP limited detent – 2 lbs (8.896 N) min. SMP smooth bore – 0.5 lbs (2.224 N) min.	SMPM full detent – 5 lbs (22.241 N) typical SMPM smooth bore – 1.5 lbs (6.672 N) typical
Radial misalignment	standard – \pm 0.25 mm/0.010 in. min. float mount – \pm 0.76 mm /0.030 in. min.	---
Axial misalignment	standard – 0.25 mm/0.010 in. min. float mount – 1.27 mm/0.050 in. min.	---

Environmental data	Test conditions	
Temperature range	-65 to +165 °C	-65 to +165 °C
Climatic category	MIL-STD-202, method 107, condition B	MIL-STD-202, method 107, condition B
Thermal shock	MIL-STD-202, method 106	MIL-STD-202, method 106
Moisture resistance	MIL-STD-202, method 101, condition B	MIL-STD-202, method 101, condition B
Corrosion	MIL-STD-202, method 204, 28 g peak	MIL-STD-202, method 204, 28 g peak
Vibration	MIL-STD-202, method 214, condition K-I, 46.3 g	MIL-STD-202, method 214, condition K-I, 46.3 g
Mechanical shock	MIL-STD-202, method 213, 12 000 g peak	MIL-STD-202, method 213, 12 000 g peak

Performance listed is typical. Individual part configuration may vary. Contact HUBER+SUHNER for more information and specifications.

Design guide

Working range (axial and radial) – mated board connector

In mated condition, the two connecting parts have to be aligned within the dimension given for the axial and radial working range. Unlike the MMBX interface, the tilt of the adapter can be limited with the MBX. The great advantage of this feature is that there now is a constant working range with different adapter lengths and thus the same standard funnel for the connecting parts can be used.

Connecting range – unmated board connector

The two connecting parts need to be aligned within the connecting range when mating. In order to guarantee a blind mateable connection, the tilted adapter will be guided by the funnel of the opposite connector. The connecting range therefore depends on the adapter and the pull-in range (size of the funnel).

Example based on MBX

Connecting range

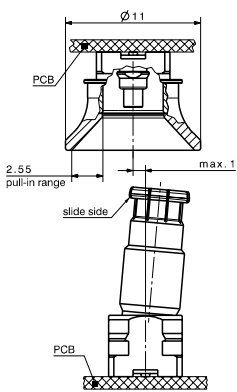

Working range

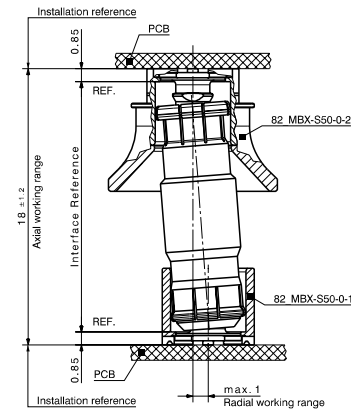

Recommendation

HUBER+SUHNER recommends using guiding pins to align the boards within the connecting range and working range as well as distance holders to maintain the axial misalignment within the working range. HUBER+SUHNER provides an outline drawing for every application with the relevant mechanical dimensions that need to be considered when designing-in our board-to-board solutions. 3D step files are available on www.hubersuhner.com

Test boards

MBX/MMBX test boards

Measurement of return loss (RL) and insertion loss (IL) of a MBX/MMBX board-to-board test board.



MBX/MMBX reference boards

Reference board to identify the insertion loss (IL) of the board-to-board connection itself.



Series MBX

Straight PCB jacks (female), surface mount type SMT

Picture	HUBER+SUHNER type	Item no.	Soldering pad
	82_MBX-S50-0-1/111_N	84104680	ML 173
	82_MBX-S50-0-2/113_N	84104681	

Straight adaptors

Picture	HUBER+SUHNER type	Item no.	Board-to-board distance	Adaptor length
	32_MBX-50-0-1/111_N	84104690	13 mm/0.512 in.	9.7 mm/0.382 in.
	32_MBX-50-0-2/111_N	84104691	18 mm/0.709 in.	14.7 mm/0.579 in.
	32_MBX-50-0-3/111_N	84104692	28 mm/1.012 in.	24.7 mm/0.972 in.

Adaptors with other lengths available upon request.

Straight PCB jacks (female), through hole type THT

Picture	HUBER+SUHNER type	Item no.	Soldering pad
	82_MBX-50-0-3/111_N	84104683	ML 174
	82_MBX-50-0-4/113_N	84104684	

Series MMBX

Straight PCB jacks (female), surface mount type SMT

Picture	HUBER+SUHNER type	Item no.	Soldering pad	Pull-in range
	82_MMBX-S50-0-1/111_N	23001785	ML 122	0.65 mm/0.0256 in.
	82_MMBX-S50-0-3/111_N	23015527		0.95 mm/0.0374 in.
	82_MMBX-S50-0-13/111_N	84032435		1.80 mm/0.0709 in.

Straight adaptors

Picture	HUBER+SUHNER type	Item no.	Board-to-board distance	Adaptor length	Min. pull-in range
	32_MMBX-50-0-1/111_N	23001749	6.7 mm/0.264 in.	4.8 mm/0.189 in.	0.65 mm/0.026 in. *
	32_MMBX-50-0-12/111_N	84004734	8.0 mm/0.315 in.	6.0 mm/0.236 in.	0.95 mm/0.037 in.
	32_MMBX-50-0-4/111_N	23010564	10.0 mm/0.394 in.	8.0 mm/0.315 in.	1.80 mm/0.071 in.
	32_MMBX-50-0-13/111_N	84031096	12.0 mm/0.472 in.	10.0 mm/0.417 in.	1.80 mm/0.071 in.
	32_MMBX-50-0-5/111_N	84026915	14.0 mm/0.551 in.	12.0 mm/0.472 in.	1.80 mm/0.071 in.
	32_MMBX-50-0-10/111_N	23034946	15.0 mm/0.591 in.	13.0 mm/0.512 in.	1.80 mm/0.071 in.

* only suitable pull-in-range

Straight PCB jacks (female), through hole type THT

Picture	HUBER+SUHNER type	Item no.	Mounting hole	Pull-in range
	82_MMBX-50-0-2/111_N	23001788	ML 15	0.65 mm/0.0256 in.
	82_MMBX-50-0-4/111_N	23013667		0.95 mm/0.0374 in.
	82_MMBX-50-0-14/111_N	84032421		1.80 mm/0.0709 in.

Straight PCB jacks (female), edge mount

Picture	HUBER+SUHNER type	Item no.	Mounting hole
	92_MMBX-S50-0-12/111_N	84019159	ML 147

Please find broader product range and details on our website or in our RF coaxial connectors general catalogue.

Series SMP

Straight PCB plugs (male)

Picture	HUBER+SUHNER type	Item no.	Detent	Operating frequency	Packaging
	81_SMP-S50-0-L1/111_NE	80377946	limited detent	DC – 40 GHz	single
	81_SMP-S50-0-S1/111_NE	80377947	smooth bore	DC – 40 GHz	single

Edge mount PCB plugs (male)

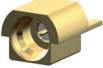
Picture	HUBER+SUHNER type	Item no.	Detent	Operating frequency	Packaging
	91_SMP-50-0-L1/111_NE	80377833	limited detent	DC – 40 GHz	single
	91_SMP-50-0-S1/111_NE	80377835	smooth bore	DC – 40 GHz	single

Adaptor/bullet jack/jack (female/female)

Picture	HUBER+SUHNER type	Item no.	Packaging	Adaptor length
	31_SMP-50-0-5/111_NE	80377837	single	8.76 mm/0.345 in.
	31_SMP-50-0-6/111_NE	80377836	single	19.30 mm/0.760 in.

Straight panel mount receptacle (male)

Picture	HUBER+SUHNER type	Item no.	Detent	Pin length	Packaging
	12_SMP-50-0-S1/119_NE	80378538	catchers mitt	0.062"/1.57 mm additional length on request	single

Series SMPM

Adaptor jack/jack (female/female)

Picture	HUBER+SUHNER type	Item no.	Packaging	Adaptor length
	29981-A2F1	80372056	single	5.33 mm/0.210 in.
	29981-A2F2	80363712	single	12.7 mm/0.500 in.
	29981-A2F3	80376811	single	6.45 mm/0.254 in.

Please find broader product range and details on our website or in our RF coaxial connectors general catalogue.

Microminiature connectors

SMP

HUBER+SUHNER SMP connectors provide a robust, proven and fully compatible plug-in solution for applications up to 40 GHz. HUBER+SUHNER SMP connectors have been MIL-SPEC qualified for defense and space flight hardware. The design of the interface and materials provide true compatibility as well as guaranteed mechanical performance with all MIL-STD-348 SMP connectors in the market over the mating life of the connector.



SMPM

HUBER+SUHNER Astrolab SMPM connectors offer unrivaled miniaturization and performance for RF applications up to 65 GHz. HUBER+SUHNER Astrolab SMPM connectors are MIL-SPEC qualified for defense and space flight applications. Along with the unique bend-to-the-end microbend style cable connectors, HUBER+SUHNER Astrolab offers a large portfolio of different PCB mount SMPM connectors that have been designed with optimized PCB trace launch geometries to offer a complete interconnect design solution from „wire-to-trace“.



SMPM-T

The SMPM-T is the smallest threaded open source connector on the market. Its unique and innovative combination of a MILSTD-348 SMPM female interface connector together with a retractable threaded nut provides an integrated solution offering unprecedented electrical and mechanical performance. The SMPMT handles high density requirements with a connector centerline-to-centerline spacing of just 5 mm (0.20 in) while offering unmatched electrical stability at frequencies up to 65 GHz in even the harshest operating environments.



VITA 67

HUBER+SUHNER VITA 67 is the first high-density and true high-performance 65 GHz coaxial interconnect system on the market. Incorporating the solderless Minibend bend-to-the-end technology tightest bending radius (0.06"/1.5 mm) immediately behind the connector, the snap-in captivation method guarantees quick, easy and precise installations without tool or loose parts. VITA 67 is designed for side-by-side implementation with VITA 46 and VITA 66 hardware. It can be assembled with diameter 0.086" and smaller cable types.

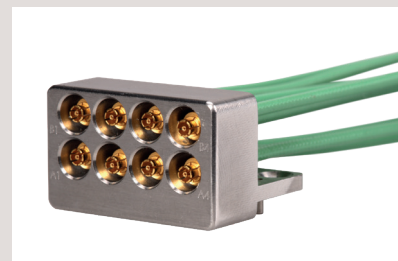

SMP – technical data

Electrical data	Requirements
Impedance	50 Ω
Frequency range	DC to 40 GHz
Contact resistance	center conductor 6.0 milliohms max. outer conductor 2.0 milliohms max.
DWV	500 Vrms at sea level
Insulation resistance	5000 megaohms min.
Corona levels	190 Vrms at 70 000 ft
RF high potential	325 Vrms at 5 MHz
RF leakage	80 dB max. at 3 GHz 65 dB max. at 3 to 26.5 GHz
Magnetic permeability	< 2 μ
VSWR	1.2:1 to 18 GHz 1.35:1 to 26.5 GHz 1.5:1 to 40 GHz
Insertion loss	0.06 \sqrt{f} in GHz (non-hermetic connectors) 0.12 \sqrt{f} in GHz (hermetic connectors)

Mechanical data	Requirements
Center contact retention	1.5 lbs (6.672 N) min. (captivated designs)
Durability	100 cycles min. into a full detent shroud 500 cycles min. into a limited detent shroud 1000 cycles min. into a smooth bore shroud
Force to engage	SMP full detent – 15 lbs (66.723 N) max. SMP limited detent – 10 lbs (44.482 N) max. SMP smooth bore – 2 lbs (8.896 N) max.
Force to disengage	SMP full detent – 5 lbs (22.241 N) min. SMP limited detent – 2 lbs (8.896 N) min. SMP smooth bore – 0.5 lbs (2.224 N) min.
Radial misalignment	standard – \pm 0.25 mm/0.010 in. min. float mount – \pm 0.76 mm /0.030 in. min.
Axial misalignment	standard – 0.25 mm/0.010 in. min. float mount – 1.27 mm/0.050 in. min.

Environmental data	Requirements
Temperature range	-65 to +165 $^{\circ}$ C
Thermal shock	MIL-STD-202, method 107, condition B
Moisture resistance	MIL-STD-202, method 106
Corrosion	MIL-STD-202, method 101, condition B
Sine vibration	MIL-STD-202, method 204, 28 g peak
Random vibration	MIL-STD-202, method 214, condition K-I, 46.3 g
Shock	MIL-STD-202, method 213, 12 000 g peak

Material data		
Cable and shroud connectors	Material	Plating
Body	beryllium copper per ASTM B- 196 or brass per QQ-B-626	SUCOPRO gold plate
	#303 SS per ASTM A- 582	passivated per SAE-AMS-2700
Contact	beryllium copper per ASTM B-196	SUCOPRO god plate
Dielectric	PTFE per ASTM D-1710, type I, grade 1 or Torlon™ per ASTM D-5204	-
Ferrule	brass per ASTM B-135	SUCOPRO gold plate

Series SMP – PCB mount connectors

Straight PCB plugs (male)

Picture	HUBER+SUHNER type	Item no.	Detent	Operating frequency	Packaging
	81_SMP-S50-0-L1/111_NE	80377946	limited detent	DC – 40 GHz	single
	81_SMP-S50-0-S1/111_NE	80377947	smooth bore	DC – 40 GHz	single

Edge mount PCB plugs (male)

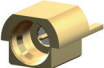
Picture	HUBER+SUHNER type	Item no.	Detent	Operating frequency	Packaging
	91_SMP-50-0-L1/111_NE	80377833	limited detent	DC – 40 GHz	single
	91_SMP-50-0-S1/111_NE	80377835	smooth bore	DC – 40 GHz	single

Series SMP – cable connectors

SMP female connector – straight

Picture	Cable types	Part no.	Item no.	Typ. return loss	
	Multiflex_86	21_SMP-50-2-1/111_NE	80390557	DC – 20 GHz:	29 dB
	Sucoform_86			20 – 30 GHz:	27 dB
	Semirigid_86			30 – 40 GHz:	20 dB

SMP female connector – right angle

Picture	Cable types	Part no.	Item no.	Typ. return loss	
	Multiflex_86	26_SMP-50-2-2/111_NE	80377839	DC – 20 GHz:	25 dB
	Sucoform_86			20 – 26.5 GHz:	20 dB
	Semirigid_86			26.5 – 30 GHz:	15 dB
				26.5 – 40 GHz:	10 dB

SMPM – technical data

Electrical data	Requirements
Impedance	50 Ω
Frequency range	DC to 65 GHz
Contact resistance	center conductor 6.0 milliohms max. outer conductor 2.0 milliohms max.
DWV	335 Vrms at sea level
Insulation resistance	5000 megaohms min.
Corona levels	125 Vrms at 70 000 ft
RF high potential	200 Vrms at 5 MHz
RF leakage	80 dB max. at 3 GHz 65 dB max. at 3 to 26.5 GHz
Magnetic permeability	< 2 μ
VSWR	1.1:1 to 26.5 GHz 1.3:1 to 65 GHz
Insertion loss	0.05 + 0.04 \sqrt{f} in GHz (non-hermetic connectors) 0.12 \sqrt{f} in GHz (hermetic connectors)

Mechanical data	Requirements
Center contact retention	1.5 lbs (6.672 N) min. (captivated designs)
Durability	100 cycles min. into a full detent shroud 1000 cycles min. into a smooth bore shroud
Force to engage	SMPM full detent – 3.5 lbs (15.569 N) typical SMPM smooth bore – 1.5 lbs (6.672 N) typical
Force to disengage	SMPM full detent – 5 lbs (22.241 N) typical SMPM smooth bore – 1.5 lbs (6.672 N) typical

Environmental data	Requirements
Temperature range	-65 to +165 °C
Thermal shock	MIL-STD-202, method 107, condition B
Moisture resistance	MIL-STD-202, method 106
Corrosion	MIL-STD-202, method 101, condition B
Sine vibration	MIL-STD-202, method 204, 28 g peak
Random vibration	MIL-STD-202, method 214, condition K-I, 46.3 g
Shock	MIL-STD-202, method 213, 12 000 g peak

Material data		
Cable and shroud connectors	Material	Plating
Body and contact	beryllium copper per ASTM B-196	gold plate per ASTM B-488, code C, type II over nickel plate per SAE-AMS-QQ-N-290, type 1
Dielectric	PTFE per ASTM D-1710, type I, grade 1 or Torlon™ per ASTM D-5204	-
Shroud	#303 SS per ASTM A-582	passivated per SAE-AMS-2700



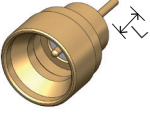

Contact HUBER+SUHNER for more information and specifications by part number.

SMPM – series

Hermetic male shrouds

Picture	HUBER+SUHNER type	Item no.	"L" mm/in	End option	Detent
	29972H1-2-030S	80376464	0.762/0.030	square	full
	29972H1-2-050S	80376465	1.270/0.050	square	full
	29972H1-2-060S	80395460	1.524/0.060	square	full
	29972H1-2-070S	80395461	1.778/0.070	square	full
	29972H1-2-090S	80395462	2.286/0.090	square	full
	29972H1-4-030S	80395463	0.762/0.030	square	smooth bore
	29972H1-4-050S	80395464	1.270/0.050	square	smooth bore
	29972H1-4-060S	80395465	1.524/0.060	square	smooth bore
	29972H1-4-070S	80395466	1.778/0.070	square	smooth bore
	29972H1-4-090S	80395467	2.286/0.090	square	smooth bore

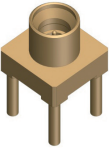
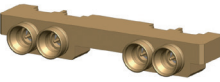
PCB mount male connectors

	HUBER+SUHNER type	Item no.	Detent
	29972S1-2-001	80367473	full
	29972S1-4-001	80367474	smooth bore
	29972SM-2-001	80367475	full
	29972SM-4-001	80367476	smooth bore
	29972T1-2-155	80395469	full
	29972T1-4-155	80395470	smooth bore
	29976CB7-2-4	80374382	full
	29976CB7-4-4	80395468	smooth bore
	29972CB2-2-002	80376772	full
	29972CB2-4-002	80376773	smooth bore

SMPM-T – technical data

Electrical data	Requirements
Impedance	50 Ω
Frequency range	DC to 67 GHz
Contact resistance	center conductor 6.0 milliohms max. outer conductor 2.0 milliohms max.
DWV	335 Vrms at sea level
Insulation resistance	5000 megaohms min.
Corona levels	125 Vrms at 70 000 ft.
RF high potential	200 Vrms at 5 MHz
RF leakage	80 dB max. at 3 GHz 65 dB max. at 3 to 26.5 GHz
Magnetic permeability	< 2 μ
VSWR	1.1:1 to 26.5 GHz 1.3:1 to 65 GHz
Insertion loss	0.05 + 0.04 \sqrt{f} in GHz (non-hermetic connectors) 0.12 \sqrt{f} in GHz (hermetic connectors)

Mechanical data	Requirements
Center contact retention	1.5 lbs (6.672 N) min. (captivated designs)
Durability	100 cycles min. into a full detent shroud 1000 cycles min. into a smooth bore shroud
Force to engage	SMPM full detent – 3.5 lbs (15.569 N) typical SMPM smooth bore – 1.5 lbs (6.672 N) typical
Force to disengage	SMPM full detent – 5 lbs (22.241 N) typical SMPM smooth bore – 1.5 lbs (6.672 N) typical

Environmental data	Requirements
Temperature range	-65 to +165 °C
Thermal shock	MIL-STD-202, method 107, condition B
Moisture resistance	MIL-STD-202, method 106
Corrosion	MIL-STD-202, method 101, condition B
Sine vibration	MIL-STD-202, method 204, 28 g peak
Random vibration	MIL-STD-202, method 214, condition K-1, 46.3 g
Shock	MIL-STD-202, method 213, 12 000 g peak

Material data		
Cable and shroud connectors	Material	Plating
Body and contact	Beryllium copper per ASTM B-196	gold plate over nickel plate per SAE-AMS-QN-N-290, type 1
Dielectric	PTFE or Torlon™ or Ultem™	-

Contact HUBER+SUHNER for more information and specifications by part number.

SMPM-T – series

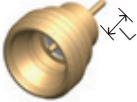

Hermetic male shrouds

Picture	Part number	Item no.	Interface	Contact type	Contact length (L)
	29976HI-2-060S	80362701	full detent	square	1.52 mm/0.06 in.
	29976HI-2-090S	80362703	full detent		2.28 mm/0.09 in.
	29976HI-4-060S	80362705	smooth bore		1.52 mm/0.06 in.
	29976HI-4-090S	80362707	smooth bore		2.28 mm/0.09 in.

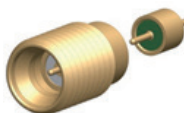

Panel mount male connectors

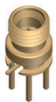
Picture	Part number	Item no.	Interface
	29976TSP-2-005	80370422	full detent SMPM-T male
	29976TSP-4-005	80374421	smooth bore SMPM-T male

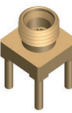
PCB mount male connectors

Picture	Part number	Item no.	Interface
	29976SI-2-140	80362694	full detent
	29976SI-4-140	80362695	smooth bore
	29976RA-2-001	80374263	full detent
	29976RA-4-001	80374264	smooth bore
	29976TI-2-155	80366706	full detent
	29976TI-4-155	80372345	smooth bore

PCB mount male connectors

Picture	Part number	Item no.	Interface
	29976BM-2-001	80320230	full detent
	29976BM-4-001	80320231	smooth bore
	29976BM-2-002	80362690	full detent
	29976BM-4-002	80362691	smooth bore
	29976BM-2-004	80366009	full detent
	29976BM-4-004	80363975	smooth bore

VITA 67 (SMMPM)– technical data

Electrical data	Requirements
Impedance	50 Ω
Frequency range	DC to 65 GHz
Contact resistance	center conductor: 6.0 milliohms max outer conductor: 2.0 milliohms max
DWV	335 Vrms
Insulation resistance	5 000 megaohms min.
Corona levels	125 Vrms at 70 000 ft
RF high potential	200 Vrms at 5 MHz
RF leakage	SHF (3 to 30 GHz): 100 dB min. VHF/UHF (30 MHz to 3 GHz): 120 dB min. HF (3 to 30 MHz): 140 dB min.
Magnetic permeability	< 2 μ
VSWR	1.1:1 to 26.5 GHz 1.3:1 to 65 GHz
Insertion loss	0.05 + 0.04 \sqrt{f} in GHz

Mechanical data	Requirements
Center contact retention	1.5 lbs (6.672 N) min
Durability	1000 cycles min. (smooth bore)
Force to engage	1.5 lbs. (6.672 N) typical
Force to disengage	1.5 lbs (6.672 N) typical

Environmental data	Requirements
Temperature range	-65 to +155 °C
Thermal shock	MIL-STD-202-107, test condition B
Moisture resistance	MIL-STD-202-106
Corrosion	MIL-STD-202-101, test condition B
Sine vibration	MIL-STD-202-204, 28 g peak
Random vibration	MIL-STD-202-214, test condition K-1, 46.3 g
Shock	MIL-STD-202-213, 12 000 g peak



Material data		
Cable and shroud connectors	Material	Plating
Body and contact	beryllium copper	gold over nickel
Dielectric	PTFE	-
Housing	passivated stainless steel	-

Contact HUBER+SUHNER for more information and specifications by part number.

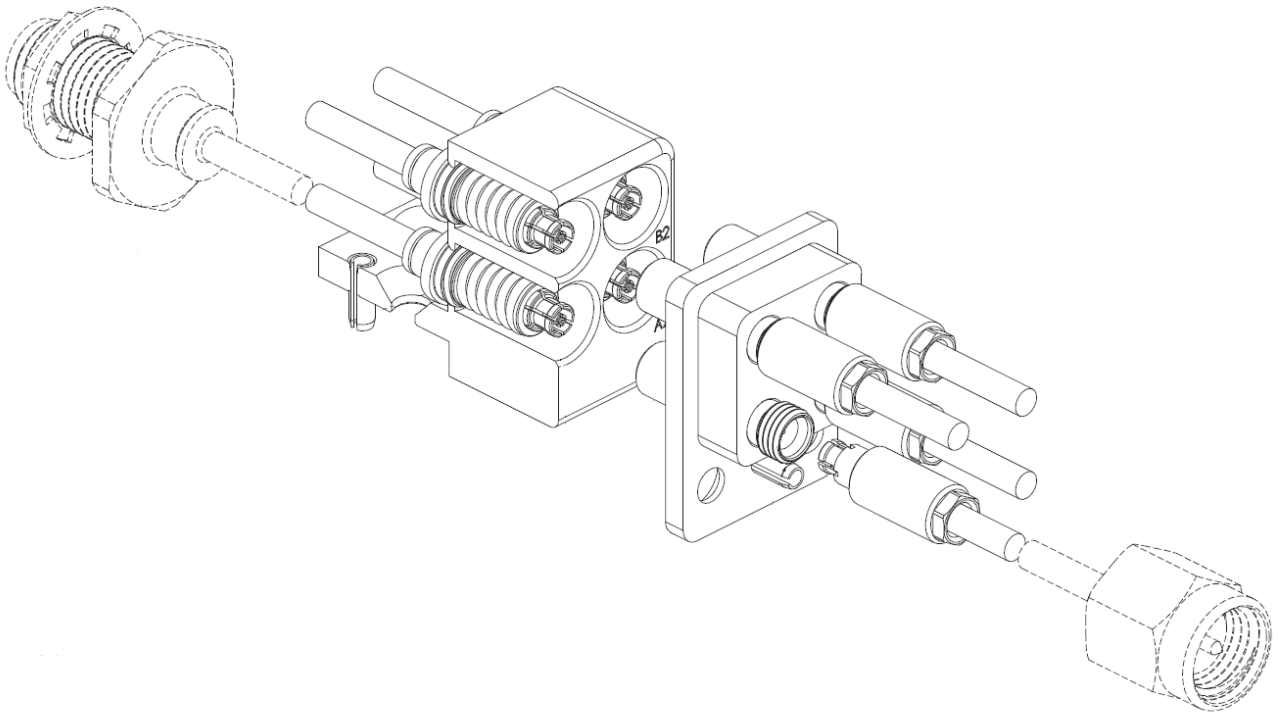
VITA 67 – series



Standard VITA parts

Picture	Version	Module type	No. of positions	Part. no	Item no.	Cable size
	VITA 67.1	daughter card	4	29981-DCM4	80391306	0.047" 0.086"
		backplane*	4	29989-MBM4	80396360	0.047"
		backplane*	4	29989-MBM4-86	80379468	0.086"
	VITA 67.2	daughter card	8	29981-DCM8	80391307	0.047" 0.086"
		backplane*	8	29989-MBM8	80379226	0.047"
		backplane*	8	29989-MBM8-86	80379469	0.086"

* Backplane connector blocks are SMPM and SMPM-T compatible

VITA tools

HUBER+SUHNER VITA 67 connector blocks utilize a snap-in captivation method of the SMPM connector allowing for "one-and-done" installation of the cable assembly into the connector block without the use of any tools and easily-misplaced loose parts as competitors solutions. De-mating the connector from the block requires the use of a single-motion plunger tool to engage the snap ring and free the connector.

Picture	Tool	Description	Item no.
	Removal tool	AT-2377-DCM1	80378115
	Insertion tool	AT-2377-DCM2	80378196

VITA 67 – series

Available cables

Cable type	Outer diameter (mm)	Bend radius static (mm)	Frequency range (GHz)	Features/benefits
Microbend	1.96	1.52	90	Bend-to-the end
Microbend L	1.96	5.10	90	Bend-to-the end/low loss
Minibend	2.50	5.08	65	Bend-to-the end
Minibend L	2.64	5.08	50	Bend-to-the end/low loss
Minibend CTR	2.49	5.08	50	Bend-to-the end < 300 PPM phase change over temperature
Sucoform 47	1.20	3.18	40	Smallest diameter available
Semirigid 47	1.20	3.18	67	Smallest diameter available

For connectors (A and B referred in the assembly drawing) all connectors are available according:

- Minibend series: refer to page 50
- All other cables according RF connector catalogue or based on the connector overview on page 76.

Attenuation (nominal values at +25 °C ambient temperature)

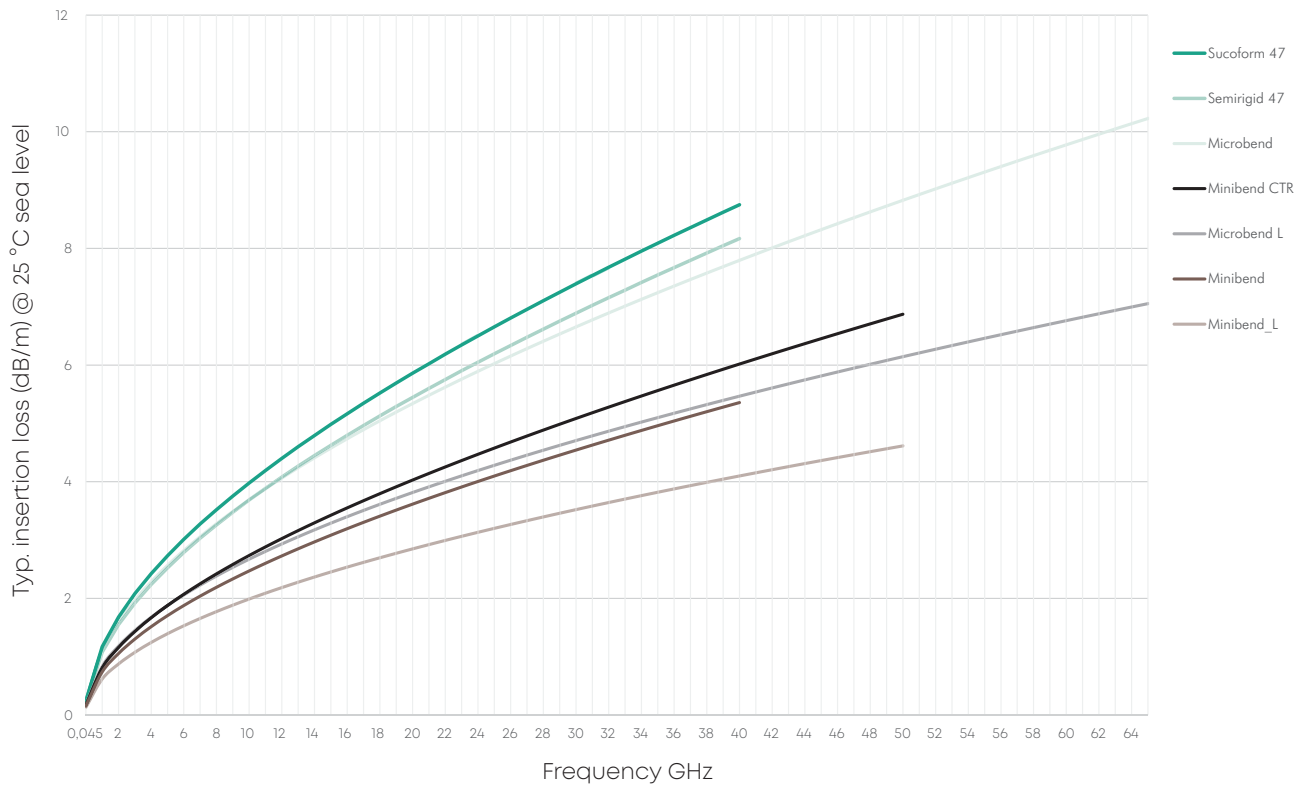



Self-locking connectors

The HUBER+SUHNER self-locking solution is a simple and easy to use connector that eliminates the need for lock-wire/safety

wire that can lead to potential FOD in an aircraft. The anti-rotation microwave connector maintains the required torque to ensure the connector interface remains fully engaged throughout the operational profile that the aircraft may experience.

Our solution features a lock-collar mechanism that once engaged prevents rotation of the coupling nut. This design results in time savings during the initial cable assembly installation by eliminating lockwires and the associated equipment necessary to install it. The size and weight of these connector assemblies are similar with standard connectors and maintains full function in harsh and/or high vibration environments.

Electrical data	TNC series	PC2.4 series
		
Interface	TNC	PC2.4
Impedance	50 Ω	50 Ω
Frequency range	DC to 18 GHz	DC to 50GHz
DWV	1.5 kV rms, 50 Hz (depending on cable)	400 kV rms
Working voltage (at sea level) – Unmated	500 V rms, 50 Hz (depending on cable)	250 Vrms
Insulation resistance	≥ 5 × 10 ³ MΩ	≥ 5 × 10 ³ MΩ
Contact resistance – Center contact – Outer contact	≤ 1.5 mΩ ≤ 1 mΩ	≥ 14 mΩ ≥ 1 mΩ

Mechanical data		
Center contact retention	46 to 69 Ncm/4.1 to 6.1 in lbs	67 N-cm/6.0 in lbs
Coupling nut retention force	≥ 450 N/101.2 lbs	≥ 450 N/101.2 lbs
Contact captivation	≥ 27 N/6.1 lbs	≥ 26.7 N/6 lbs
Durability	≥ 500	≥ 500

Environmental data		
Temperature range	–65 to +165 °C	–55 to +125 °C
Thermal shock	MIL-STD-202, method 107, condition B	MIL-STD-202, method 107
Vibration	MIL-STD-202, method 204, condition B	MIL-STD-202, method 204, condition B
Shock	MIL-STD-202, method 213, condition G	MIL-STD-202, method 213, condition G

Available standard parts

Cable type	TNC straight	PC2.4 straight
SUCOFLEX 229 (D)	•	
SUCOFLEX 240 (D)		•
SUCOFLEX 329 (D)	•	
SUCOFLEX 340 (D)		•

Please refer to the microwave cable assembly section for more information on SUCOFLEX 200/300 – page 28/30
Contact HUBER+SUHNER for more information and specifications by part number and in the event additional configurations are required.

QMA/QMA-W50

HUBER+SUHNER QMA coaxial connectors comply with the QLF standard and are available with 50 Ω impedance. The QMA connectors are return loss optimized for frequencies up to 18 GHz. The interface is based on the SMA dimension, but instead of a threaded coupling mechanism, a new snap-lock mechanism is used. The QMA interface has very similar performance to the SMA, but it offers an easier, faster and safer coupling operation, which helps customers save significant time during production or installation. QMA connectors are also available in a waterproof version (IP68) and are compatible with the QLF standard.



- Easy to mate, 10 times faster than with threaded SMA
- Increased reliability, waterproof IP68 (QMA-W50)
- No torque or tooling required
- 360° rotatable interface
- Easy routing of cable assembly without mechanical stress or electrical performance degradation
- Higher packing density
- Size equivalent to SMA, but space saving (no torque wrench required)
- Excellent electrical performance
- Consistent VSWR performance enables easily replacement



XQMA (QMA eXtreme, waterproof IP68)

In addition to the outstanding qualities of the quick lock connector QMA, this advanced version has some extra advantages such as protection from corrosion in a salty atmosphere and from freezing in the event of high humidity and low temperature.

QN

HUBER+SUHNER QN coaxial connectors are available with 50 Ω impedance. The frequency range extends to 11 GHz, depending on the connector and cable type, however most of the QN connectors are return loss optimized for frequencies up to 6 GHz. The interface is based on the inner dimensions of the N connector but instead of a threaded coupling mechanism a snap-lock mechanism is used. The QN interface has a very similar performance to N, but in addition it offers an easier, faster and safe coupling operation, which helps customers save significant time during production or installation of their systems.



- Cycle time improvement for making RF connections (10 times faster to mount than threaded connectors)
- No torque or tooling required
- Higher packaging density
- Free-rotating connection when mated (cable torsion relief)
- Eliminates loosening problems associated with threaded connectors
- Same performance as N
- Best intermodulation



XQN (QN eXtreme, waterproof IP68)

Besides the outstanding qualities of the quick lock connector QN, this advanced version has some extra advantages such as protection from corrosion in a salty atmosphere and from freezing in case of high humidity and low temperature.

Customized connectors – service and support

HUBER+SUHNER offers a professional design-in service for board connector footprints. By the use of three dimensional electro-magnetic field simulators the optimal performance of the HUBER+SUHNER board connectors is provided to the customer.

HUBER+SUHNER provides comprehensive design data collections to their customers:

3D files

For the exchange of CAD models between various CAD systems, HUBER+SUHNER provides 3D files in IGS or STEP data format.

S-parameter files

Measured S-parameters of the HUBER+SUHNER components are available on request, offering the customers the possibility to include these components into their electrical simulations.

Application notes

Many application notes and technical design guidelines for the HUBER+SUHNER solutions are available on request.

Although our standard assortment is broad, there are customer requirements which require a unique solution. Thanks to our design and manufacturing capabilities and years of RF experience, HUBER+SUHNER is the ideal partner when customized solutions are required.

We offer a broad range of different platings ideally suited for your specific need. In addition to the standard gold and silver-platings we have additional platings with superior performance:

- SUCOPRO – the gold plating of the future (minimizes gold-embrittlement)
- SUCOPLATE – the outdoor plating
- Black silver/black chrome – camouflage or non-reflective for tactical equipment

HUBER+SUHNER has a team of specialists supporting your application. We have more than 25 years of experience within the industry and have successfully participated in many programs. Capitalize on our broad knowledge of connectors, cables, cable assemblies and EMPs.

Customized and optimized PCB footprints

Comprehensive design data

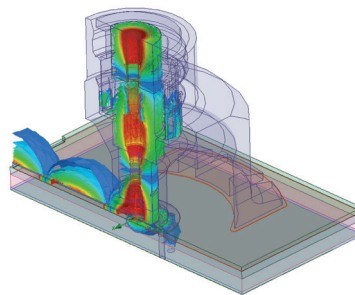

Non standard connectors

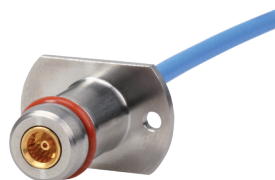

Plating technology



Application engineering

Adaptors

HUBER+SUHNER manufactures a wide range of adaptors in various configurations such as within series or between series, straight or angled designs and some with panel mount features. They are classified according to their typical intended applications, each of which requires specific properties.

Standard adaptors

- Wide range of different configurations
- Appropriate materials
- Most common interfaces available
- Accurate transitions
- Effective and reliable interconnection solutions
- IP68 rated



Precision adaptors

- Precision interfaces
- Excellent electrical performance
- Premium base materials and platings
- For precision laboratory measurements
- High repeatability and accuracy



Low PIM adaptors

- Outstanding low intermodulation performance
- Excellent electrical contacts
- Non-magnetic materials
- High reliability
- Repeatable intermodulation measurements



Hermetically sealed adaptors

- Glass-fired seal
- 100 % tested
- Wide temperature range
- Hermetically sealed feed-thru
- Leakage rate: 10⁻⁸ Torr l/sec



MIL approved adaptors

- Materials, finishes and performance per MIL-PRF-55339
- Interfaces according to MIL-STD-348
- Extensive portfolio of configurations
- Extensive flight heritage in aircraft and satellite applications
- Precision measurement performance



Customer specific adaptors

Adaptors can be designed according to your application specific requirements:

- Between/in-series adaptors
- Stainless steel, beryllium copper, brass materials
- Gold, passivated, SUCOPRO®, SUCOPLATE® platings



Adaptors – portfolio overview

		SMPM-T		MMBX		MMCX		MCX		MMPX		SMPM		PC 1.85		SMP		PC 2.4		SK (2.92 mm standard)		PC 3.5		SMA		QMA		N		
		plug	jack	plug	jack	plug	jack	plug	jack	plug	jack	plug	jack	plug	jack	plug	jack	plug	jack	plug	jack	plug	jack	plug	jack	plug	jack	plug	jack	
SMPM-T	plug																				*	*								
	jack																					*	*							
MMBX	plug																							*	*					
	jack																							*	*		*			
MMCX	plug				*																		*	*		*				
	jack					*																	*	*		*				
MCX	plug							*														*	*		*	*				
	jack								*													*	*		*	*				
MMPX	plug									*					*						*	*								
	jack										*				*						*	*								
SMPM	plug										*										*	*								
	jack											*									*	*								
PC 1.85	plug									*			*	*							*	*								
	jack									*			*	*							*	*								
SMP	plug										*						*	*			*	*								
	jack										*						*	*			*	*								
PC 2.4	plug																			*	*								*	
	jack																			*	*							*		
SK 2.92 mm standard	plug	*								*	*	*			*	*	*	*	*	*	*	*								
	jack	*								*	*	*			*	*	*	*	*	*	*	*								
PC 3.5	plug							*	*												*	*			*	*	*	*	*	*
	jack							*	*												*	*			*	*	*	*	*	*
SMA	plug			*	*	*	*	*	*													*	*		*	*	*	*	*	*
	jack			*	*	*	*	*	*													*	*		*	*	*	*	*	*
QMA	plug																			*	*		*	*	*	*	*	*	*	*
	jack				*																*	*		*	*	*	*	*	*	*
N	plug																*	*	*	*	*	*			*	*	*	*	*	*
	jack													*	*	*	*	*	*	*	*	*			*	*	*	*	*	*

 Standard adaptors

 Precision adaptors

More details about our adaptor portfolio can be found in our RF connector catalog online or our dynamic product finder.

Phase shifter



The phase shifter product family is designed for use in electronic systems where precision adjustment and tuning of transmission line electrical lengths are required. The phase shifter, or line trimmer, is designed to allow precise in-line phase change while maintaining constant VSWR and insertion loss performance values.

The construction of the phase shifters incorporates fine gauge threads for precise tuning accuracy at a resolution of less than 0.1 degrees. A variety of interfaces and phase adjustment ranges are available with operation up to 26 GHz.

These passive devices have proven successful in aerospace and satellite programmes with flight heritage in both North America and Europe.

Phase shifter – portfolio

Type	Interfaces		Frequency range (GHz)		Total $\Delta\Phi$		VSWR		Dimension (mm)		Dimension (inch)	
	1	2	min	max.	min	max.	min	max.	closed	open	closed	open
40002C	SMA plug	SMA plug	0.1	4.0	4°	160°	1.05:1	1.28:1	108.71	143.00	4.28	5.63
40003C	SMA plug	SMA jack	0.1	4.0	4°	160°	1.05:1	1.28:1	105.66	139.95	4.16	5.51
40004C	SMA jack	SMA jack	0.1	4.0	4°	160°	1.05:1	1.28:1	103.38	137.67	4.07	5.42
40019C	N plug	TNC jack	0.1	4.0	4°	160°	1.15:1	1.35:1	117.86	152.15	4.64	5.99
40020C	TNC jack	TNC jack	0.1	4.0	4°	160°	1.15:1	1.35:1	129.79	164.08	5.11	6.46
40002A	SMA plug	SMA plug	0.5	8.0	35°	570°	1.08:1	1.25:1	159.00	218.44	6.26	8.60
40003A	SMA plug	SMA jack	0.5	8.0	35°	570°	1.08:1	1.25:1	155.96	215.39	6.14	8.48
40004A	SMA jack	SMA jack	0.5	8.0	35°	570°	1.08:1	1.25:1	153.67	213.11	6.05	8.39
40006A	N plug	N jack	0.5	8.0	33°	538°	1.08:1	1.25:1	164.34	220.47	6.47	8.68
40007A	N jack	N jack	0.5	8.0	33°	538°	1.08:1	1.25:1	163.07	219.20	6.42	8.63
40002B	SMA plug	SMA plug	8.0	18.0	97°	219°	1.25:1	1.40:1	58.42	68.58	2.30	2.70
40003B	SMA plug	SMA jack	8.0	18.0	97°	219°	1.25:1	1.40:1	53.37	65.58	2.18	2.58
40004B	SMA jack	SMA jack	8.0	18.0	97°	219°	1.25:1	1.40:1	52.07	62.23	2.05	2.45
40005B	N plug	N plug	8.0	18.0	102°	230°	1.25:1	1.40:1	73.91	84.58	2.91	3.33
40006B	N plug	N jack	8.0	18.0	102°	230°	1.25:1	1.40:1	73.15	83.82	2.88	3.30
40007B	N jack	N jack	8.0	18.0	102°	230°	1.25:1	1.40:1	68.83	79.50	2.71	3.13
40011B	N jack	SMA plug	8.0	18.0	92°	208°	1.25:1	1.40:1	60.71	70.36	2.39	2.77
40004D	SMA jack	SMA jack	8.0	26.0	146°	474°	1.25:1	1.37:1	56.90	72.90	2.24	2.87
40004E	SMA jack	SMA jack	8.0	26.0	146°	474°	1.25:1	1.37:1	56.90	72.90	2.24	2.87

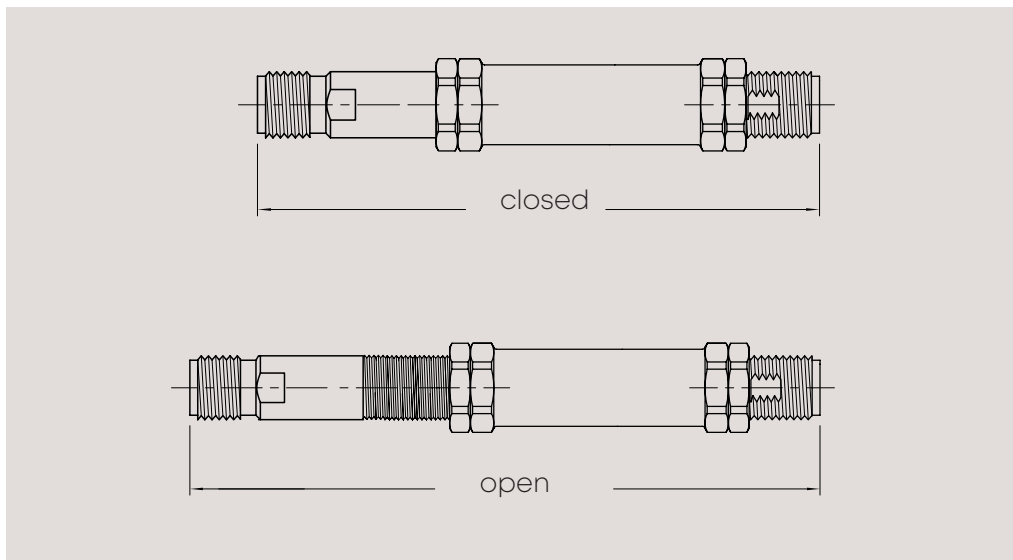

Environmental qualification levels

Thermal shock:	MIL-STD-202, Method 107, 100 cycles, -55/+125 °C
Sine vibration:	MIL-STD-202, Method 204, 21 g peak
Random vibration:	MIL-STD-202, Method 214, 26.1 g rms
Mechanical shock:	MIL-STD-202, Method 213, 750 g peak.

HEMP and lightning protection



Four decades of experience in developing and manufacturing coaxial- and data line-HEMP and LEMP protectors are the foundation of our current EMP protector portfolio and have made HUBER+SUHNER a first stop for protection solutions in defense applications. HUBER+SUHNER offers protection components for landbased, airborne and naval tactical communications as well as for navigation, radar and electronic warfare applications.

Our products are designed to meet the stringent requirements of the defense and security markets. An extensive high-voltage impulse laboratory is available to verify our designs in accordance with the valid lightning, surge and HEMP standards.

HUBER+SUHNER holds groundbreaking patents in the field of coaxial lightning and HEMP protection, such as the automatically suppressing surge arrester (Semper).

Many of our products are referenced by the NATO Maintenance and Supply Agency (NAMSA).

Further informations

[External document](#) 

Threat scenario in defense applications

The threat mechanisms by which high level energy surges are generated can be separated into the two groups of natural occurrences and man-made energy surges. The natural phenomenon of lightning (LEMP) has been extensively investigated. Cloud-earth or earth-cloud flashes with currents up to 400 kA are generated as soon as the electrical field strength exceeds 100 kV/m. Good lightning protectors shall be capable of handling large currents without being degraded.

The frequency content of lightning goes up to ≈ 1 MHz. Man-made surges can be unintentional when they originate from high power switching of electric engines or intentional when they are created by specific weapons, radar equipment or high power communication transmitters. The three categories of intentional created surges are:

- The HEMP or high altitude electromagnetic pulse. Its interference mechanism derives from Gamma radiation generated during a nuclear explosion at high altitude. This radiation displaces electrons from the molecules in the upper atmosphere (Compton Effect) which causes the high level HEMP/ NEMP (nuclear EMP) pulse. Such high altitude nuclear explosion can affect a huge area, several hundreds of kilometers in diameter, on the earth. HEMP/NEMP

protectors shall be capable of diverting fast pulses (ns rise times) on a path with minimal inductance to ground. The HEMP pulse has significant spectral components up to ≈ 300 MHz.

- The HPM/UWB pulse. Meanwhile several non-nuclear mechanisms have been developed that produce even faster effects than the HEMP. The technique of using fast pulse generators that receive their energy either from conventional TNT explosions or from large capacitors (Marx generator) built into bombs (E bombs) or missiles is well known. The frequency content of Ultra wideband pulses (UWB) ranges from 500 MHz to 5 GHz. High power microwave sources (HPM) generate narrow band signals extending from 1 to 10 GHz. Protectors against HPM and UWB signals must be capable to react within pico-seconds.
- Radar pulse streams and other transmitters with high continuous or pulsed power are a threat for any sensitive RF receivers on board of vessels and airplanes. Classic examples are jets landing on an aircraft carrier or signal exploitation hardware on warships. Protection components which limit the received signals to a non-hazardous level are demanded in this scenario.

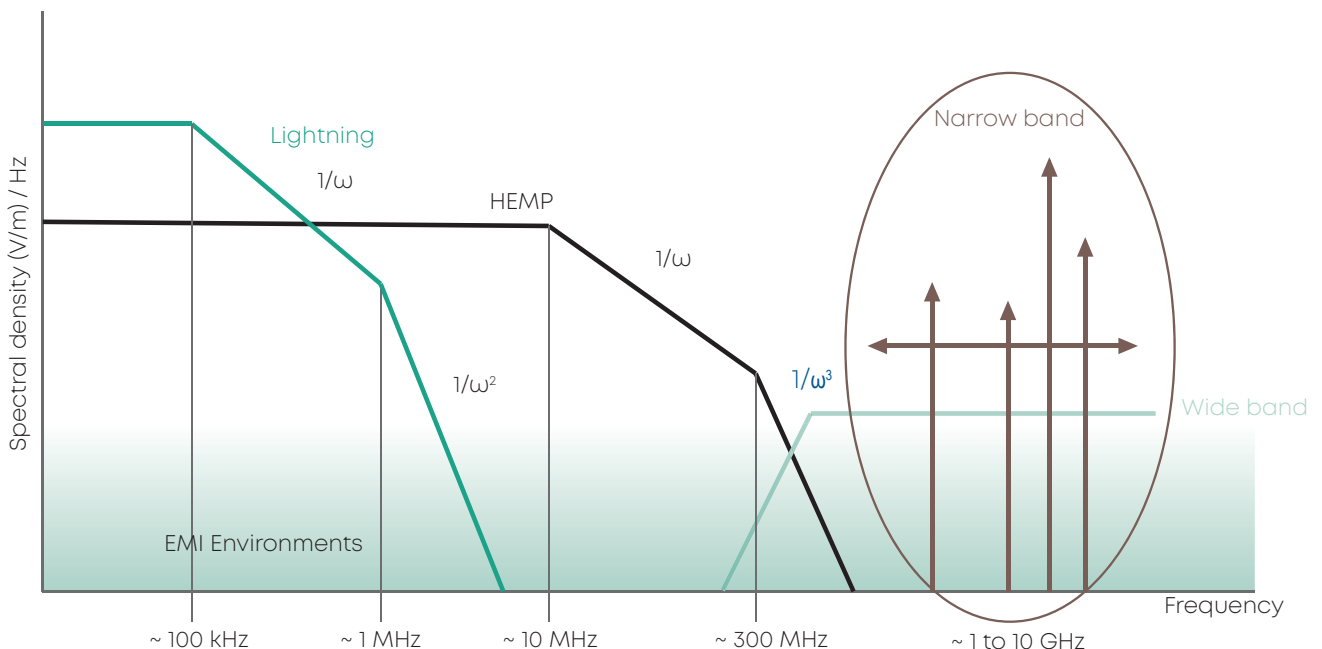

- Lightning: significant spectral components up to ~ 1 MHz
- HEMP: significant spectral components up to ~ 300 MHz
- Wide band (e.g. UWB/SP): extending > 500 MHz to 5 GHz
- Narrow band (e.g. HPM/HiRF): extending from ~ 1 to 10 GHz
- EMI environments

Lightning protection – product overview

Gas discharge tube protectors with exchangeable GDTs

Series 3401/3402 (standard versions)

For applications with RF and DC components on the antenna line the standard GDT lightning/ EMP protectors feature DC continuity and large bandwidth. Most HUBER+SUHNER GDT protector designs provide excellent performance in the NEMP application as well. For specific applications internally DC-blocked GDT protectors are available.



Self-extinguishing GDT protectors (Semper)

The HUBER+SUHNER Semper design guarantees safe extinguishing of the GDT under high RF power or with additional DC components on the antenna line. By retrofitting standard GDTs with the Semper GDT existing installations can be upgraded. The Semper technology is a true improvement to the standard gas tube technology and increases reliability and lifetime of GDT protectors.



True broadband GDT protectors

Series 3404/3406

SlimLine GDT protectors feature high return loss in the frequency band between DC and 6 GHz. This design is best suited for point to point and WLAN equipment.



Hybrid/low PIM/high power GDT protectors

Series 3409

This patented technology features low passive intermodulation at extremely high continuous and peak instantaneous power (up to 25 kW PIP).



Bias-T/DC injectors with integrated lightning protector

Series 3410

Bias-T's, used to „feed-in“ or „pick-off“ DC voltage into or from antenna feeder cables, provide the operating voltage for active electronics installed on the mast (mast head amplifiers, etc.)



Hybrid GDT fine protectors

Series 3403

For very sensitive DC powered receivers such as those used in GPS installations, the hybrid GDT fine protectors with integrated transient voltage suppressor diodes guarantee lowest residual pulse energy. HUBER+SUHNER fine protectors feature DC continuity.



Quarter-wave shorting stub protectors

Series 3400

HUBER+SUHNER quarter-wave shorting stub protectors perform best lightning parameters with excellent RF specifications within limited bandwidth. A ratio of 4:1 between lowest and highest frequency of the frequency band is achievable by still meeting high return loss. For specific applications internally DC-blocked quarter-wave shorting stub protectors are also available.



Filter protectors

Series 3407

LC or LCL band pass filter technologies allow an increase in bandwidth to ratios larger than 4:1 in a compact mechanical design, hence they are an alternative to quarter-wave shorting stub protectors. LC or LCL filter protectors are internally DC-blocked.



Data line protectors

Series 3414 (twisted pair, ethernet)

Our CAT 5 and CAT6 (Gigabit) data line protectors are „Power Over Ethernet“ compatible and available as IP68 rated robust components for outdoor applications (i.e. backhaul microwave links) or in IP20 specified housings for indoor installations (i.e. data processing centers).



Semper – self-extinguishing gas discharge tube protector



The patented Semper™ concept enhances the safety and reliability of the well-known gas discharge tube (GDT) protector principle impressively. It eliminates the risk of gas discharge tube "hold on" due to DC line powering or high RF signals which will render the system inoperable and can destroy the GDT. The Semper™ invention is based on a mechanical resettable thermo-switch which is integrated within the GDT protectors capsule holder.

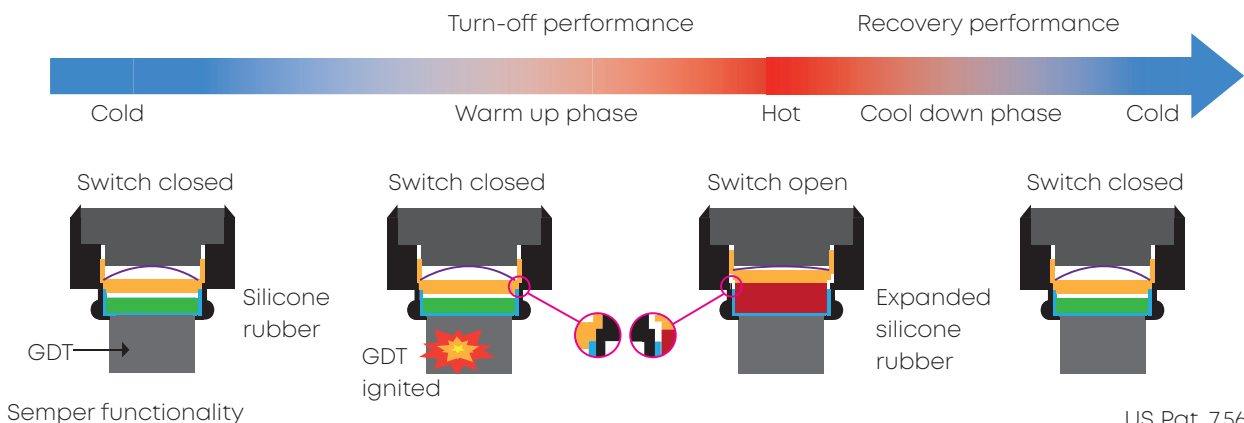

Gas discharge tube (GDT) protectors

This technology features bandwidths from DC – 6 GHz and can handle surge currents up to 30kA. GDT technology allows DC voltage on the center conductor. By selecting the correct GDT these products can be used in applications with transmit power up to 1 kW CW. For applications with higher power please consult the factory. A special version of this technology is represented by the self-extinguishing GDT protector (Semper). GDT technology provides reliable protection against natural and man-made surges.

Picture	HUBER+SUHNER type	Freq. range (MHz)	Connectors	Mounting	RL min. (dB)	IL max. (dB)	IP rating
	3401.01.A	DC – 300 300 – 1000	BNC (f) – BNC (f)	MH12	26 19	0.1 0.1	IP20
	3401.01C	DC – 1000	BNC (m) – BNC (f)	MH12	26 19	0.1 0.1	IP20
	3401.02.A	DC – 400 400 – 1000	BNC (f) – BNC (f)/75 Ω	MH12	20 15	0.1 0.2	IP20
	3401.26.A	DC – 300 300 – 1000	TNC (f) – TNC (f)	MH12	26 19	0.1 0.1	IP64
	3401.26.C	DC – 300 300 – 1000	TNC (m) – TNC (f)	MH12	26 19	0.1 0.1	IP20
	3401.26.0012-EX**	DC – 1000	TNC (f) – TNC (f)	MH12	19	0.1	IP64
	3401.17.A	DC – 1000	N (f) – N (f)	MH12	26	0.1	IP65
	3401.17.C	DC – 1000	N (m) – N (f)	MH12	26	0.1	IP65
	3401.17.K	DC – 1000	N (f) – N (f)	MH12	26	0.1	IP66
	3401.17.0048-EX **	DC – 1000	N (f) – N (f)	MH12	24	0.1	IP65
	3401.17.0057-EX **	DC – 1000	N (m) – N (f)	MH12	24	0.1	IP65
	3401.17.0056 ****	DC – 1000	N (m) – N (f)	MH12	26.4	0.1	IP67
	3402.17.A	DC – 2500	N (f) – N (f)	MH25	20	0.2	IP65
	3402.17.C	DC – 2500	N (m) – N (f)	MH25	20	0.2	IP65
	3402.17.K	DC – 1000 1000 – 2500	N (f) – N (f)	MH25	26 20	0.1 0.2	IP66
	3402.17.0033 ***	DC – 2500	N (f) – N (f)	MH25	20	0.2	IP65
	3402.17.0072-EX **	DC – 2500	N (f) – N (f)	MH25	20	0.2	IP65
	3402.17.0076-EX **	DC – 2500	N (m) – N (f)	MH25	20	0.2	IP65
	3402.17.3001	DC – 2000 2000 – 3000	N (f) – N (f)	MH25	26 20	0.2 0.3	IP67
	3402.17.3002	DC – 2000 2000 – 3000	N (m) – N (f)	MH25	26 20	0.2 0.3	IP67
	3402.18.A	DC – 1500 1500 – 2000	N (f) – N (f)/ 75 Ω	MH25	16.5 15.5	0.2 0.2	IP65
	3402.26.0002	DC – 2500	TNC (f) – TNC (f)	MH25	20	0.2	IP65
	3402.26.0004	DC – 2500	TNC (m) – TNC (f)	MH25	20	0.2	IP65
	3402.26.0006-EX *	DC – 2500	TNC (f) – TNC (f)	MH25	20	0.2	IP65
	3402.26.3001	DC – 1000 1000 – 3000	TNC (f) – TNC (f)	MH170	26 20	0.2 0.3	IP65
	3402.27.0001	DC – 1500 1500 – 2000	TNC (f) – TNC (f)/75 Ω	MH25	16.5 15.5	0.2 0.2	IP65
	3404.00.0011	DC – 3000	TNC(f)-MMCX(f)	MH119	20	0.25	IP68
	3404.00.0012	DC – 3000	N(f)-MMCX(f)	MH119	20	0.25	IP68
	3406.17.0009	DC – 5600 5600 – 5800 5800 – 6000	N (f) – N (f)	MH24	20 18.5 15	0.2	IP65
	3406.17.0012	DC – 5600 5600 – 5800 5800 – 6000	N (m) – N (f)	MH24	20 18.5 15	0.2	IP65
	3406.26.0010	DC – 2000	TNC (m) – TNC (f)	MH4	20	0.2	IP65
	3406.00.0030	DC – 3000	N (f) – SMA (f)	5/8-4UNEF	20	0.2	IP65

- * Semper GDT 9071.99.0648 (90 V) integrated
- ** Semper GDT 9071.99.0647 (230 V) integrated
- *** GDT 9071.99.0547 (230 V) integrated
- **** GDT 9071.99.0550 (470 V) integrated

Quarter wave shorting stub and LC-filter protectors

$\lambda/4$ shorting stub technology can handle extremely high surge currents and features very low residual energy. No DC voltage is allowed on the center pin. Bandwidths with a ratio of 4:1 can be realized. Depending on the selected interface they can be used in applications up to 5 kW CW.

Picture	HUBER+SUHNER type	Freq. range (MHz)	Connectors	Mounting	RL min. (dB)	IL max. (dB)	IP rating
	3407.17.0022	74 – 180	N (f) – N (f)	MH74	20	0.15	IP66
	3407.17.0088	74 – 420	N (m) – N (f)	MH74	23	0.15	IP67
	3407.17.0089	74 – 420	N (f) – N (f)	MH74	23	0.15	IP67
	3407.17.0023	220 – 450	N (m) – N (f)	MH74	20	0.1	IP65
	3407.17.0053	320 – 512	N (m) – N (f)	MH12	20	0.2	IP65
	3400.17.0388	380 – 512	N (m) – N (f)	MH74	20	0.1	IP65
	3400.17.0254	1000 – 1100	N (f) – N (f)	MH12	20	0.1	IP65
	3400.17.0385	950 – 1450	N (f) – N (f)	MH25	20	0.1	IP65
	3400.17.0247	2400 – 3600	N (m) – N (f)	MH50	20	0.15	IP67
	3400.17.0410	2000 – 6000	N (f) – N (f)	screw M8	20	0.2	IP65
	3400.17.0235	5000 – 7000	N (f) – N (f)	MH25	20	0.25	IP65
	3400.17.0380	6000 – 18 000	N (f) – N (f)	MH69	20	0.3	IP65

Hybrid GDT fine protectors

For sensitive DC powered electronics such as GPS receivers the Hybrid GDT fine protector with integrated suppressor diodes guarantees lowest residual pulse energy.

Picture	HUBER+SUHNER type	Freq. range (MHz)	Connectors	Mounting	RL min. (dB)	IL max. (dB)	IP rating
	3403.17.0050	650 – 2500	N (f) – N (f) /15 V	MH119	20.8	0.5	IP65
	3403.17.0051*	806 – 2500	N (m) – N (f) /15 V	M6/2 × Ø 4.2	20.8	0.5	IP65
	3403.17.0075	800 – 2500	N (f) – N (f) /6 V	MH12	26.4	0.3	IP67

* HEMP optimized

High power limiter

Limiters are multi-stage hybrid components which reduce harmful RF power at its input to a defined power level at the output. The special feature of the presented high power limiter is that it is not only limiting but at the same time it is capable of protecting against lightning- and NEMP pulses.

Picture	HUBER+SUHNER type	Freq. range (MHz)	Connectors	Mounting	RL min. (dB)	IL max. (dB)	IP rating
	9078.17.0013	0.1 – 32 MHz	N (f) – N (f)	MH12	18	0.5	IP67
	9078.17.0014	0.1 – 32 MHz	N (f) – N (f)	MH12	20	0.7	IP67
	9078.17.0015	0.1 – 50 MHz	N (f) – N (f)	MH12	20	0.7	IP67

HUBER+SUHNER type	RF average power	RF peak power	Limiting threshold	Surge current handling capability	Residual pulse energy (LEMP) 2 kA; 8/20 µs/4 kV; 1.2/50 µs	Residual pulse energy (NEMP) 6 kV; 5/200 ns	Response time
9078.17.0013	≤ 25 W ≤ 44 dBm	≤ 5 kW ≤ 67 dBm	10 – 12.6 W 40 – 41 dBm	10 kA (8/20 µs)	300 µJ	30 µJ	< 100 ns
9078.17.0014	≤ 25 W ≤ 44 dBm	≤ 1 kW ≤ 60 dBm	4 mW 6 dBm	10 kA (8/20 µs)	200 µJ	–	< 2 ns
9078.17.0015	≤ 25 W ≤ 44 dBm	≤ 1 kW ≤ 60 dBm	16 mW 12 dBm	10 kA (8/20 µs)	200 µJ	–	< 2 ns

Data line protectors

Data line protectors for twisted pair applications are available as Cat 4, 5 and 6. We offer IP20 designs for indoor usage and ruggedized IP68 protectors.

Picture	HUBER+SUHNER type	Ethernet	Connectors	Mounting	Frequency (MHz)	Data rate (Mbps)	IP rating
	3414.99.0003	Cat5 (class D)	RJ45	screw	100	1000	IP20
	3414.99.0008	Cat5 (class D)	RJ45	clamp	100	1000	IP68
	3414.99.0009	Cat5 (class D)	RJ45	MH180	100	1000	IP68
	3414.99.0021	Cat6 (class E)	RJ45	DIN Rail	250	1000	IP20
	3414.99.0022	Cat6 (class E)	RJ45	clamp	250	1000	IP68
	3414.99.0024	Cat4 (class C)	D38999/24FA35SN	MH181	20	16	IP68

HUBER+SUHNER type	
9073.99.0002	RJ45 plug kit, field assembly for 3414.99.0009
9073.99.0004	protective cap for data line protector 3414.99.0009
9073.99.0003	protective cap for RJ45 plug kit 9073.99.0002

Mounting holes

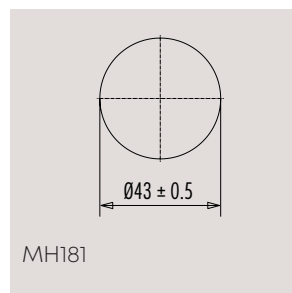
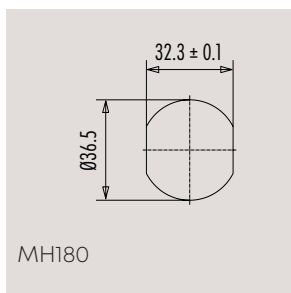
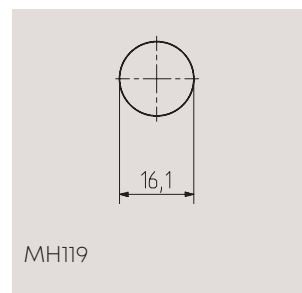
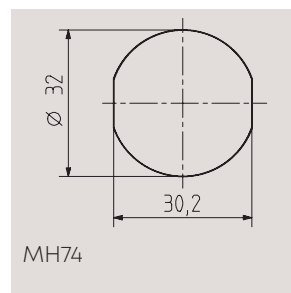
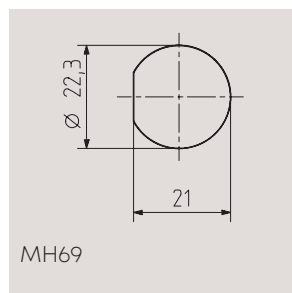
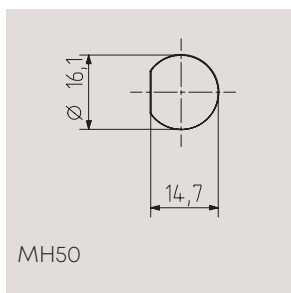
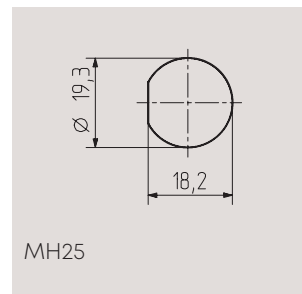
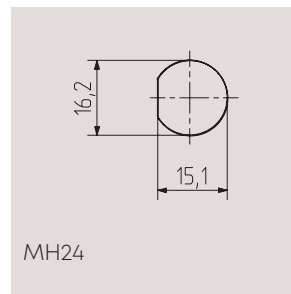
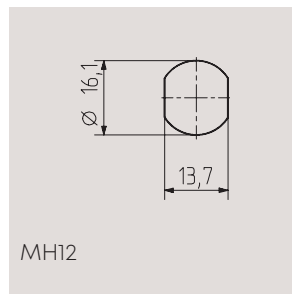
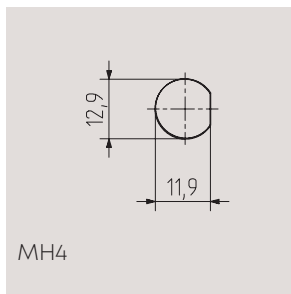

NATO registered surge protective devices (EMP/HEMP)

NATO stock no. (NSN)	HUBER+SUHNER type	Description
5920-12-325-4220	3401.01.A	50 Ω , 1 GHz, BNC(f) – BNC(f)
5920-17-106-6384		
5935-99-110-3099		
5920-12-310-6281	3401.01.F	50 Ω , 1 GHz, BNC(f) – BNC(f), GDT holder with chain
1450-23-113-7610	3401.02.A	75 Ω , 0.4 GHz, BNC(f) – BNC(f)
5920-12-338-0883		
5920-99-147-6582	3401.17.0045	50 Ω , 1 GHz, , N(f) – N(f), 350 V GDT included
5820-99-726-4346	3401.17.A	50 Ω , 1 GHz, , N(f) – N(f)
5920-01-565-8254		
5920-14-516-6621		
5920-17-100-7884		
5920-66-127-4034		
5920-01-485-4062		
5920-01-545-4178	3401.17.C	50 Ω , 1 GHz, N(m) – N(f)
5920-12-321-2510	3401.17.K	50 Ω , 1 GHz, , N(f) – N(f), GDT holder with chain
5920-25-134-3502	3401.18.A	75 Ω , 1 GHz, N(f) – N(f)
5920-01-596-7066	3401.26.A	50 Ω , 1 GHz, TNC(f) – TNC(f)
5920-17-113-6448		
5920-66-138-2463		
5920-25-144-6357	3401.27.A	75 Ω , 0.4 GHz, TNC(f) – TNC(f)
5920-99-297-6617	3402.00.0043	50 Ω , 2.5 GHz, 4/11(f) – N(f), GDT holder with chain
5920-99-665-6391	3402.00.0044	50 Ω , 2.5 GHz, 4/11(f) – N(m), GDT holder with chain
5920-01-615-2087	3402.17.0043	50 Ω , 2.5 GHz, N(m) – N(f)
5920-01-421-4919	3402.17.A	50 Ω , 2.5 GHz, N(f) – N(f)
5920-17-105-4779		
5920-99-773-3078		
5920-01-461-3214	3402.17.C	50 Ω , 2.5 GHz, N(m) – N(f)
5920-12-330-1428		
5920-12-332-5482	3402.17.K	50 Ω , 2.5 GHz, N(f) – N(f), GDT holder with chain
5920-01-570-0497	3406.00.0012	50 Ω , 3 GHz, N(f) – SMA(f), GDT fix installed
5920-01-494-8295	3407.17.0023	50 Ω , 220 to 450 MHz, N(f) – N(f)
5920-99-776-5629	9071.99.0052	gas discharge tube, 900 V, 8 × 8 mm together with holder
5820-99-202-8264	9071.99.0053	gas discharge tube, 1200 V, 8 × 8 mm together with holder
5920-12-356-2329	9071.99.0054	gas discharge tube, 1500 V, 8 × 8 mm together with holder
5920-12-356-2540	9071.99.0447	gas discharge tube with holder, 230 V
5920-01-576-2146	9071.99.0448	gas discharge tube with holder, 90 V
5920-12-356-2327		
5920-12-356-2328	9071.99.0451	gas discharge tube with holder, 600 V
5920-14-542-1015	9071.99.0547	gas discharge tube with holder, 230 V
5920-01-597-6253		
5920-01-565-8253		
5920-01-565-8255		
5895-01-624-3840		
5895-01-624-3840	9078.17.0013	limiter, 50 Ω , 0.1 to 32 MHz

The NATO Stock Number (NSN) is a 13 digit number and is divided into 3 parts:

- The first part (4 digits): is the NATO Supply Classification Code and relates the item to the group and class of similar items: e.g. 5920: 59 for Electrical and Electronic Equipment Components and 5920 Fuses, Arrestors, Absorbers and Protectors.
- The middle part (2 digits): indicates the NCB assigning the NSN: country code: e.g. 00/01 for US, 12 for Germany, 13 for Belgium, 14 for France, 15 for Italy, 17 for Netherlands, 23 for Greece, 33 for Spain, 66 for Australia, 99 for UK
- The final part (7 digits): of the NSN does not have inherent significance. However, the number is assigned to one and to only one Item of supply within the codifying country.

Antennas



The emerging need for interoperability in communications, jamming and timing and positioning presents tremendous challenges for military applications. Traditional communication systems have been independently designed without the bandwidth, power, or interoperability needed for today's applications. Advanced communications require integration of legacy capability with new waveforms and platforms.

HUBER+SUHNER offers a broad range of antennas for a multitude of applications in communications, jamming and timing and positioning. Our antennas cover a broad frequency range from 1 MHz up to 6 GHz supporting all communication bands, allowing for a seamless transition between legacy and future requirements. While offering a small and compact footprint, our antennas still provide exceptional performance levels and are designed to meet harsh environment conditions.

- Low profile/shark fin design
- Broad frequency range
- High power capability
- Rugged design
- Customer-specific adaptations

GPS antennas

The GPS L1/L2 antennas are ideally suited for exterior installations on roofs or mounting poles as well as mounting brackets. Our antennas contain large selective patch antennas and an RF band pass filter that attenuates cellular and radar frequency ranges in order to minimize interferences and blocking effects.



Vehicle antennas

HUBER+SUHNER's wideband vehicle antennas (380 to 6000 MHz) are an essential part of today's sophisticated RF systems used in tactical communication and electronic countermeasure (ECM) applications. Designed to provide maximum performance and durability, the HUBER+SUHNER vehicle antennas are the best choice for installations on all types of vehicles as well as for fixed installations.



SENCITY Shield

The SENCITY Shield product line was specifically developed to meet today's challenging requirements for ECM missions in military and security applications. The low profile/shark fin design ensures low visibility while still providing exceptional electrical performance in terms of horizontal gain and high power capabilities.



UHF/VHF antennas

Additionally, HUBER+SUHNER offers a broad range of additional UHF/VHF antennas suited for communication and electronic countermeasure applications. Contact your local HUBER+SUHNER representative for more information.



GPS antennas





Electrical data	GPS antenna L1	GPS antenna L1+L2
		
Frequency range	typ. 1575.42 MHz min./max. 1565 to 1613 MHz	L1 typ. 1589 MHz min./max. 1565 to 1613 MHz L2 typ. 1235 MHz min./max. 1218 to 1253 MHz
Impedance	50 Ω	50 Ω
VSWR	1.5	1.5
Peak gain	low gain module: 20 dBi high gain module: 25 dBi	20 dBi
Power supply	3 to 5 VDC	3 to 5 VDC
Mechanical and environmental properties		
Dimensions	76 × 21 mm	76 × 21 mm
Weight	0.13 kg	0.13 kg
Radome material	PA6	PA6
Radome color	black/green/other on request	black/green/other on request
Operating temperature range	-40 to +85 °C	-40 to +85 °C
Waterproof	IP69	IP69
Cable pig tail	RG174/straight SMA	RG174/straight SMA

GPS splitter



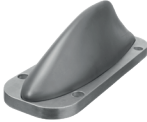

This device makes it possible to use a single GPS referencing antenna for synchronization of systems, increasing capacity without increasing the need for additional GPS antennas or cabling requirements.

Vehicle antennas

Antennas	Type	Frequency (MHz)	Gain (dBi)	Power (W)	Requirements	Weight (kg)
				@ 25 °C/sea level	Dimensions (mm)	
	1399.99.0120	698 to 960 1710 to 2170 2400 to 2700 3400 to 3700 4900 to 5935	5 5 7 9.5 8	up to 500	100 × 90 × 256	1.000
	1399.17.0094	698 to 960 1710 to 2170 2400 to 2700 3400 to 3700 4900 to 5875	4 4 8 7.5 7.5	up to 1000	100 × 153 × 256	1.600
	1399.99.0037	690 to 960 1700 to 2200 2400 to 2500 1500 to 1700 2500 to 2700	5 5 5 6 6	on request	100 × 40 × 145	0.530
	1399.99.0222	690 to 960 1700 to 2200 2500 to 2700 2400 to 2500 5100 to 6000	5 8 8 8 8	up to 250	103 × 82 × 353	1.500

SENCITY Shield

Antennas	Type	Frequency (MHz)	Gain (dBi)	Power (W)	Requirements	Weight (kg)
				@ 25 °C/sea level	Dimensions (mm)	
	1399.17.0030 Mag mount	694 to 960 1350 to 1710 1710 to 2700 2700 to 3400 3400 to 4900 4900 to 6000	3.5 6 6 7.5 7.5 8	up to 400	119 × 102 × 276	1.75
	1399.17.0050 Mag mount	694 to 960 1350 to 1710 1710 to 2700 2700 to 3400 3400 to 4900 4900 to 6000	4.5 6 6 6.5 8 8	up to 400	120 × 105 × 316	2.25
	1399.17.0051	694 to 960 1350 to 1710 1710 to 2700 2700 to 3400 3400 to 4900 4900 to 6400	5 6 6.5 9 8 8	up to 500	75 × 78 × 313	1.20

Service: Painted antennas



Our antennas can be ordered with an additional painting service in order to match the exact color of your equipment.

Please contact HUBER+SUHNER for more details.

Wires and cables

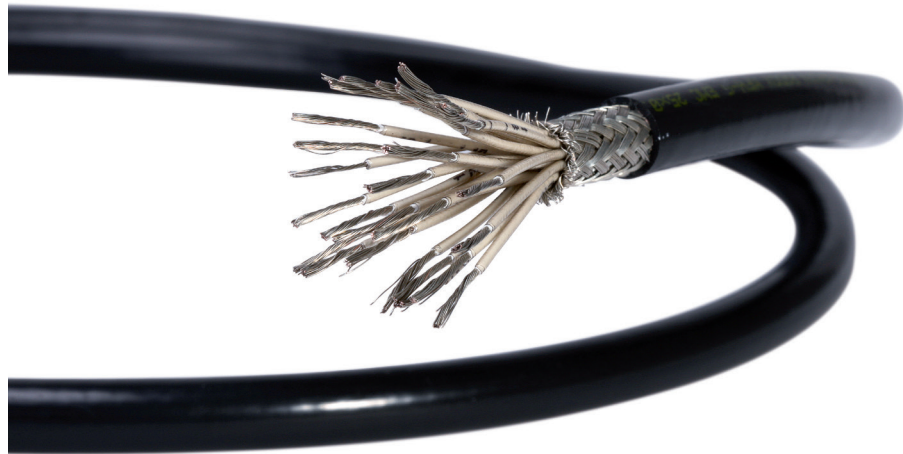

HUBER+SUHNER develops and produces high grade solutions that are suitable for the most extreme environment conditions. They can be installed in very tight spaces and will satisfy even the most stringent demands.

HUBER+SUHNER is the professional partner in the development and production of system solutions which incorporate all of our knowledge and engineering expertise.

RADOX® single core and multi core cables were developed and produced for high grade defense solutions.

- Wide temperature range
- Fixed and mobile applications
- Small overall diameter
- Flexible and rugged
- Light-weight and space saving solutions
- Chemical and mechanical resistance

Further informations

[External document](#) 

[External document](#) 

RADOX® MFH-S

The extensive RADOX® MFH-S cable portfolio meets the most challenging requirements in naval applications. The cables are suited to support both signal and power transmission. The high abrasion and vibration resistance and a very small bending radius are a key asset for congested environments on ships or submarines. The RADOX® material was developed to avoid hazardous fumes in the event of a fire.



VG/MIL cables

HUBER+SUHNER has a wide product range of different wires according to the MIL and VG standard used extensively throughout industry. These applications include commercial wiring avionics, aircraft, helicopters, ships, trains, offshore platforms and high performance military electronics or wherever there is a demand for reliable performance under extreme conditions.



Power distribution cables

The characteristics of these RADOX cables make them ideal for use in a wide range of applications, where space is at a premium and where cables are subjected to high temperatures. Even high humidity levels and motor vehicle fluids do not negatively affect the lifetime of the cables.



Data cables

The broad range of different data cable is based on our extensive expertise in data communication with electron-beam-cross-linked material technology. The databus cables provide reliable solutions for use in high-temperature applications and harsh environmental conditions. Extended temperature range, resistance against UV (sun), oil and other aggressive chemicals are mandatory performance parameters for a reliable communication link.

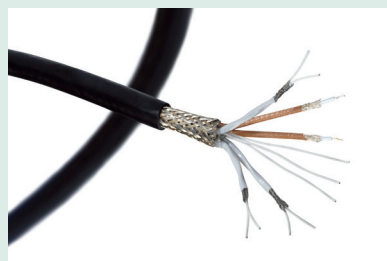

RADOX® MFH-S

MFH-S Multi cores and twisted pairs screened and unscreened

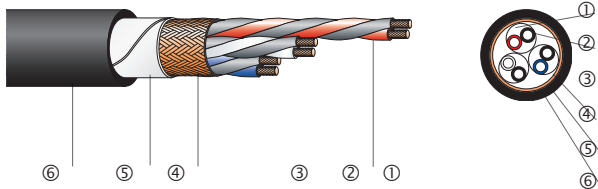

- Ozone, hydrolysis, chemical resistant
- Weatherproof
- Easy to process
- Light weight
- Wide operating temperature range
- Halogen free
- Flame retardant

Application

For fixed installations in dry, damp or wet locations, inside and outside of ships, industrial equipment, defense equipment, buses, other vehicles and railway rolling stock.

Composition of cable

① Center (if necessary)	RADOX filler
② Cores type Conductor	MA14; RADOX TI301 (145 °C/20 000 hours) stranded tin plated copper, acc. to EN 60228, class 5 optional with pair screen and drain wire
Core colors	see table
③ Fillers (optional)	RADOX
④ EMV screening	optimized tin plated copper braid, optical coverage: ≥ 85 %
⑤ Separator	textile yarn
⑥ Sheath	RADOX elastomer S FH (SHF 2; SHF mud NEK 606) Color black and blue

Technical data

Voltage rating U ₀ /U	600/1000 V AC		
Test voltage	3500 V AC		
Temperature range	-50 up to +145 °C		
Min. bending radius	static	≤ 12 mm	3 × cable-dia.
		≥ 12 mm	4 × cable-dia.
	dynamic	> 12 mm	5 × cable-dia.
		> 12 mm	6 × cable-dia.

Fire tests

Flame propagation:		
Vertical of a single cable	EN 50265-2-1, IEC 60332-1	
Content of halogen acid gas	EN 50267-2-1, IEC 60754-1	0 mg/g

Fire protection in rolling stock:

Level of protection	DIN 5510	Level 1 – 4
Hazard level	EN 45545	HL1 – HL3

Approvals

GERMANISCHER LLOYD	certificate no. 43159-02 HH	
DNV	certificate no. E-12873	TAP DNV 827.11
NEK 606	mud resistant	NEK TS 606, 4.1
ABS (American Bureau of Shipping)	certificate no. 15-GD1369103-PDA	

RADOX® MFH-S

Extract from our delivery programme

Multi cores

Cross section	R20 IEC 60228	Overall screen cross section	Cable	Core colors	Weight
n × mm ²	max. Ω/km	mm ²	Ø mm		nom. kg/100 m
3 × 0.5	40.1	2.11	5.75 ± 0.3	bk, bu, bn	6.4
5 × 0.75	26.7	2.9	7.35 ± 0.3	bk, bu, bn, gy, light blu	10.9
7 × 0.75	26.7	3.43	8.35 ± 0.3	bk, bu, bn, gy, light blu, wh, og	14.1
12 × 0.75	26.7	3.96	9.55 ± 0.3	wh num	18.8
25 × 0.75	26.7	5.94	12.9 ± 0.4	wh num	33.6
37 × 0.75	26.7	9.98	14.8 ± 0.4	wh num	50.0
50 × 0.75	26.7	11.64	17.1 ± 0.5	wh num	64.8
3 × 1.5	13.7	2.9	7.45 ± 0.3	bk, bu, bn	11.8
5 × 1.5	13.7	3.96	8.9 ± 0.3	bk, bu, bn, gy, light blu	16.8
7 × 1.5	13.7	4.0	10.1 ± 0.4	bk, bu, bn, gy, light bu, wh, og	21.7
12 × 1.5	13.7	5.55	11.9 ± 0.4	wh num	31.4
3 × 2.5	8.21	2.9	8.6 ± 0.3	bk, bu, bn	15.6
5 G 2.5	26.7	4.36	10.5 ± 0.4	gnye, bu, bn, bk, gy	23.7
19 × 2.5	8.21	10.9	17.9 ± 0.5	wh num	73.4
3 × 4	4.8	3.7	9.8 ± 0.3	bk, bu, bn	22.0
4 × 4	5.09	5.22	13.0 ± 0.4	bu, bn, bk, bk	29.7
3 × 6	3.2	4.22	11.3 ± 0.4	bk, bu, bn	30.1
8 × 2.5 und 2 × 0.75	26.7	9.98	15.3 ± 0.5	wh num	47.7

Twisted pairs

Cross section	R20 IEC 60228	Overall screen cross section	Cable	Core colors	Weight
n × mm ²	max. Ω/km	mm ²	Ø mm		nom. kg/100 m
2 × 0.5	40.1	2.11	5.55 ± 0.3	bk, bu	5.8
2 × 2 × 0.5	40.1	2.38	7.9 ± 0.3	bk, bu, bn, gy	10.1
2 × (2 × 0.5)	40.1	3.17	8.3 ± 0.3	bk, bu, bn, gy	12.0
5 × 2 × 0.5	40.1	3.96	9.75 ± 0.3	wh num	16.4
7 × 2 × 0.5	40.1	4.75	11.8 ± 0.4	wh num	22.8
14 × 2 × 0.5	40.1	9.98	14.1 ± 0.4	wh num	34.8
14 × (2 × 0.5)	40.1	9.98	15.5 ± 0.5	wh num	45.5
4 × 2 × 0.75	26.7	3.96	10.0 ± 0.3	wn num	16.4
4 × (2 × 0.75)	26.7	4.75	10.5 ± 0.3	wh num	21.3
8 × 2 × 0.75	26.7	9.98	11.6 ± 0.4	wn num	24.5
12 × 2 × 0.75	26.7	9.98	15.6 ± 0.5	wh num	43.9
12 × (2 × 0.75)	26.7	11.64	17.1 ± 0.5	wh num	54.0
19 × 2 × 0.75	26.7	11.64	18.3 ± 0.5	wh num	60.4
8 × (2 × 1.5)	13.7	13.86	19.5 ± 0.5	wh num	72.4
16 × (2 × 1.5)	13.7	16.63	24.0 ± 0.5	wh num	122.2
2 × 4	5.09	3.7	10.8 ± 0.4	bk, bu	18.6
2 × 2 × 2.5	8.21	5.55	13.7 ± 0.4	bk, bu, bn, gy	28.7
2 × (2 × 2.5)	8.21	5.15	13.9 ± 0.4	bk, bu, bn, gy	33.0
2 × 2 × 4	4.8	9.98	16.6 ± 0.5	bk, bu, bn, gy	46.8
2 × 6	3.2	4.36	10.7 ± 0.4	bk, bu	24.4
2 × 2 × 6	3.2	13.3	18.9 ± 0.5	bk, bu, bn, gy	58.9

VG cables

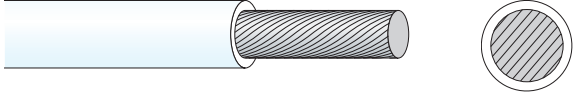
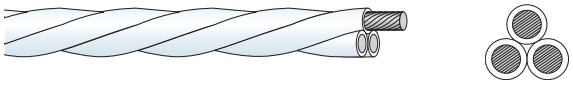
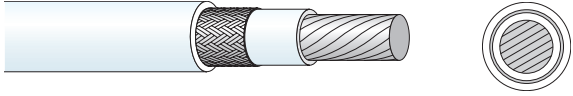
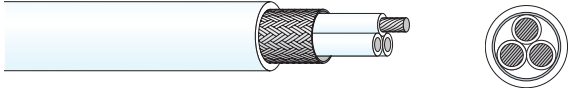
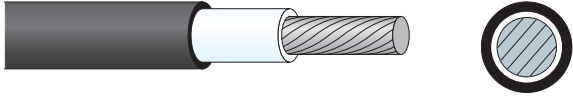
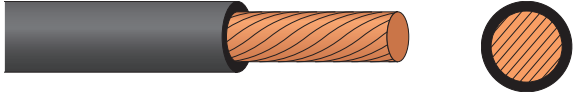
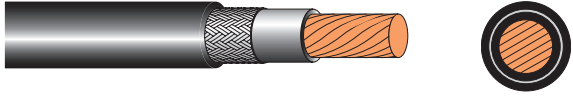
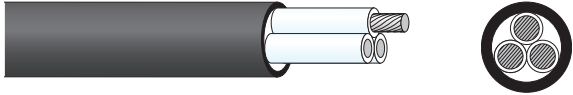
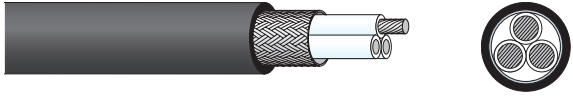
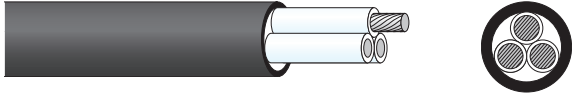
Description	Construction
Part no. 20 of cable construction Type A Single core insulated wire, 600 V, rated temperature up to +150 °C	
Part no. 21 of cable construction Type E Multicore insulated wire, open stranded 600 V, rated temperature up to +150 °C	
Part no. 22 of cable construction Type C Single core insulated wire, screened with sheath 600 V, rated temperature up to +150 °C	
Part no. 23 of cable construction Type F Cable, screened 600 V, rated temperature up to +150 °C	
Part no. 24 of cable construction Type K Single core insulated wire, with sheath 600 V, rated temperature up to +150 °C	
Part no. 25 of cable construction Type G Single core insulated wire, high flexible 600 V, rated temperature up to +150 °C	
Part no. 26 of cable construction Type H Single core insulated wire, high flexible, screened, with sheath 600 V, rated temperature up to +150 °C	
Part no. 27 of cable construction Type B Cable 600 V, rated temperature up to +150 °C	
Part no. 28 of cable construction Type A Cable, double screen 600 V, rated temperature up to +150 °C	
Part no. 28 of cable construction Type D Cable, screened 600 V, rated temperature up to +150 °C	

Please find more product details in our "Wires and cables for industrial applications" catalog.



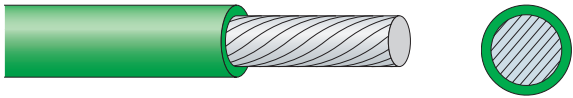
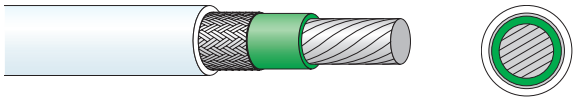
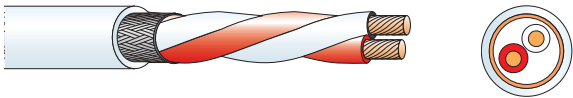
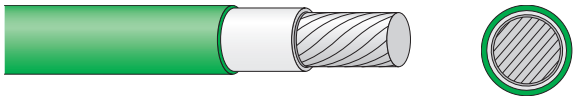
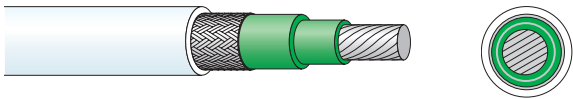
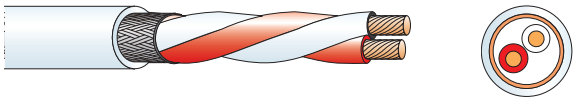



MIL cables

Description	Construction
<p>MIL 5932 A1</p> <p>Single core 600 V, rated up to +150 °C</p>	
<p>MIL 5932 E1</p> <p>Single core, screened 600 V, rated up to +150 °C</p>	
<p>MIL 5932 E2</p> <p>screened pairs 600 V, rated up to +150 °C</p>	
<p>MIL 4412 A1</p> <p>Single core, dual insulated 600 V, rated up to +150 °C</p>	
<p>MIL 4412 E1</p> <p>Single core, dual insulated, screened 600 V, rated up to +150 °C</p>	
<p>MIL 4412 E2</p> <p>screened pairs 600 V, rated up to +150 °C</p>	

Constructions and dimensions acc. to MIL-W-22759.

Please find more product details in our "Wires and cables for industrial applications" catalog.

Power distribution cables

Description	Construction
<p>RADOX® anticapillary (single insulation)</p> <p>Single core, 1 to 10 mm² 600 V, rated up to +150 °C</p>	
<p>RADOX® anticapillary (double insulation)</p> <p>Single core, 1 to 6 mm² 600 V, rated up to +150 °C</p>	
<p>RADOX® 155 battery cable, flexible (FLR4IX or FLR9IX)</p> <p>Single core, thin wall, 10 to 150 mm² 600 V, rated up to +150 °C</p>	
<p>RADOX® Elastomer S battery cable, high flex (FLR33X)</p> <p>Single core, thin wall, 10 to 150 mm² 600 V/1000 V, rated up to +150 °C</p>	
<p>RADOX® Elastomer S battery cable, flex (FL33X)</p> <p>Thick wall Single core, 10 to 150 mm² 600 V/1000 V, rated up to +150 °C</p>	
<p>RADOX® screened battery cable (FLRXC33X-1x__T150)</p> <p>Single core, 10 to 150 mm² 600 V/1000 V, rated up to +150 °C</p>	
<p>RADOX screened multicore cable</p> <p>multi core: 2 to 5 conductors 600 V/1000 V, rated up to +150 °C</p>	

Please find more product details in our "Automotive products" catalog.

RADOX® Databus cables

RADOX® Milcat 7

- High speed data transmission
- 600 Mhz at 100 Ohm
- Resistance to acid, alkali, mud and weathering
- Can be fitted with M12 connectors

Applications

- Fixed and mobile installations
- Gigabit Ethernet for tough industrial environments

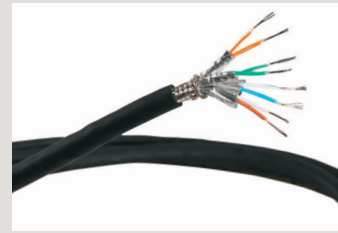

RADOX® Milcat 5e

- Cat5e performance
- Temperature resistant to -40 °C
- Very good wear resistance
- Flame-resistant

Applications

- Military communication
- Extended possible uses
- UV-resistance renders suitable for outdoor use
- Tough industrial environments

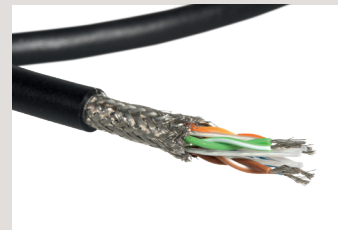

RADOX® Marine Cat 5e

- Cat5e performance
- DNV tested
- Extremely robust design
- Wear, pressure and vibration-resistant
- Flame, oil and mud-resistant to NEK606

Applications

- Data transmission to ships' diesel engines
- Industrial environments where robust design and fluid resistance are required

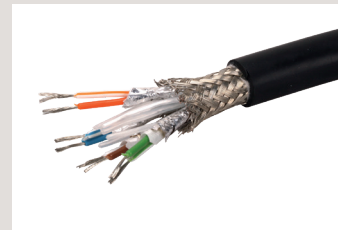

RADOX® Databus 120 Ω

- CAN technology
- GL tested
- Largely resistant to acids, oil and other chemical media

Applications

- Databus communication in ships
- Can be installed in dry and wet areas



RADOX® MFH-S B Multipair

- Interference-resistant signal and data transmission
- DNV and ABS tested
- Temperature range from -50 to +145 °C
- Flame, oil and mud resistant to NEK606
- Flame resistant to IEC60332-1-2 and IEC606332-3-22

Applications

- Indoor and outdoor installations
- Fixed and moving installations
- Ship building, offshore or other industrial applications with particularly high requirements

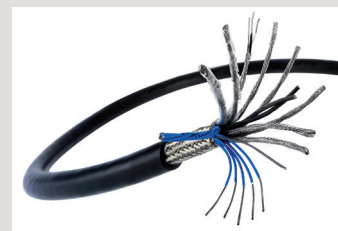

Fiber optics



HUBER+SUHNER offers a broad range of fiber optic cabling solutions for communication that meet the requirements of the defense ground and naval applications. Mobile systems have to be compact, light, robust and resistant to environment influences. On ships only halogen free and self-extinguishing cables are installed to give the highest protection to personnel and equipment in the event of fire.

The components as well as the assemblies are tested extensively in HUBER+SUHNER's test laboratory and in external labs. The tests are performed according to international and military standards. Typical tests are:

- Thermal tests: temperature cycling, humidity, shock
- Mechanical tests: tension, bending, crush, impact, vibration, durability
- Fire tests: fire propagation, circuit integrity, smoke density, toxic gases
- Ingress resistance: water and dust tightness
- Fluid resistance: water, oils, fuels, solvents, acids

Connectors

HUBER+SUHNER offers a wide range of fiber optic connectors optimized for both indoor and outdoor applications. Customer-specific connectors are also available in addition to a comprehensive standard product portfolio. All fiber optic connectors meet the highest mechanical and thermal specifications.



Cables

HUBER+SUHNER offers a broad selection of different fiber optic cables used in a wide range of indoor and outdoor applications and optimized for stationary and mobile use. All cable types are developed for maximum capacity and tested extensively according to international standards.

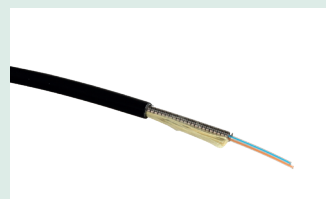

Assemblies/cable systems

HUBER+SUHNER is the leading supplier of harsh environment fiber optic interfaces. Our expertise in developing ruggedized assemblies means that they can be installed in the most demanding environments where factors such as extreme temperatures, vibrations and humidity create challenges to overcome. The ODC for example, is easy-toinstall and was developed to meet the requirements of its surroundings.



Backpack

HUBER+SUHNER fiber optic backpacks consist out of a modular system. This enable us to provide customer specific solutions to meet mission specific requirements and allow an easy and fast deployment of temporary fiber optic links suitable to withstand extreme environmental conditions.



Fiber management systems

HUBER+SUHNER supports all products that enable the deployment of future-proof and easy-to-install fiber management for temporary camp installations. Our fiber management solutions are a key enabler for C4ISTAR shelter installation and a flexible mission-based adaptation.



Waveform Division Multiplexing (WDM)

We offer all types of optical muxes, ranging from simple Wideband WDM over Coarse WDM to Dense WDM. In order to combine the different WDM grids and/or cascade several muxes we must also provide the matching WDM bandsplitters.

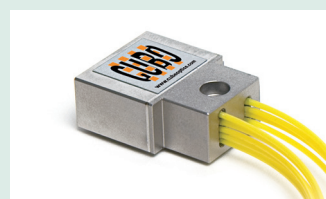

Connectors for harsh environment

Technical data	Q-ODC	Q-ODC-12	ODC [®] -2/ODC [®] -4	EBC	TFOCA/TFOCA II [®]
					
Technology	full ceramic 1.25 mm ferrule and sleeve	plastic ferrule (PPS)	full ceramic 1.25 mm ferrule and sleeve	hermaphroditic expanded beam	hermaphroditic expanded beam
Number of fibers	2	≤ 12	2/4	2/4	2/4/6/12
Protection class	IP67	IP68	IP68	IP67	IP67
Fiber types	singlemode and multimode	singlemode and multimode	singlemode and multimode	singlemode and multimode	singlemode and multimode
Operating temperature ¹⁾	-40 to +85 °C	-40 to +85 °C	-40 to +85 °C	-46 to +85 °C	-46 to +85 °C
Mating durability	200 ²⁾	100 ²⁾	1000 ²⁾	3000	2000 (multimode) 1000 (singlemode)
Mechanical performance	tensile load 450 N plug ≤ 30 N socket	tensile load 500 N plug ≤ 30 N socket	tensile load 800 N plug ≤ 30 N socket	tensile load 1500 N 500 free falls from 1.2 m height	tensile load 1500 N 500 free falls from 1.2 m height
Protection cap	snap-on	snap-on	screwed	screwed	screwed

¹⁾ depending on cable type

²⁾ with repeated cleaning

Further cable types are available.

Fiber optic cables

	Cable type	Weight (kg/km)	Number of fibers	Jacket Ø (mm)	Jacket material
	Mobile field cables	24	2	5.6	TPU
	Rugged minicord breakout cables	28	2	6.0	TPU
	Simplex cables with tight tube	3	1	0.6	TPU
	Jellyfree – dry block glass-armoured multi-fiber loose tube cables 7.0 mm	96	2 to 24	7.0	LSFH
	OptiPack cable	8.3	12	3.0	LSFH
	Glass-armoured riser cables with 2 tubes	26 35	2 2	4.8 5.5	LSFH LSFH
	Glass-armoured riser cables with 4 fibers	33	4	5.5	LSFH
	Rolling stock fiber optic cable RADOX® with 4 fibers	191	4	9.6	LSFH
	Rolling stock fiber optic cable RADOX® with 2 fibers	53	2	7.0	LSFH

External document 

Fiber optic assemblies

HUBER+SUHNER can configure robust assemblies to meet customer requirements from our wide range of connectors and patch cables.

ODC assemblies

- Robust ODC industrial connectors
- Protected end faces
- Safe installation – blind mating
- Dustproof and watertight
- For harsh environmental conditions

Applications

- Connecting access points in buildings or outdoors
- Control cabinet cabling



Q-ODC-12 link cable assemblies

- Standard Q-ODC-12 (m/f) connectors
- Various lengths
- Rodent protection, UV resistant, robust
- Compatible with all Q-ODC-12 interfaces

Applications

- MLUSC connection cable
- Connection cable from the control room to the control cabinets with modular expansion



Robust cable assemblies

- With all typical fiber types
- Standard connectors incl. SFF
- For harsh environmental condition

Applications

- Connecting access points in buildings
- Control cabinet cabling

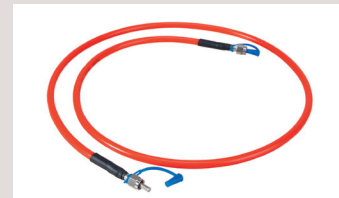

Patch cables

- Simplex and duplex
- Standard connectors incl. SFF
- Connector types with automatic protective caps

Applications

- Connecting fiber fan-out modules and access points in distribution boxes
- Distribution enclosure patches

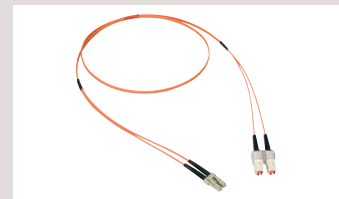

Customer specific assemblies

- Broad range of connectors: EBC, TFOCA (II), 38999
- Various lengths
- Rodent protection, UV resistant, robust
- MIL approved cables

Applications

- Tactical network installations
- Backpack cables



Fiber optic cable systems

A variety of cable systems can be configured to meet customer requirements. Pre-terminated cable systems offer the following advantages:

- Can be installed directly and quickly, immediately operational
- No splicing or connector assembly required on site
- Cost savings thanks to simple and time-saving installation
- Little expertise required

MASTERLINE Ultimate

- Pre-terminated „plug & play“ solution
- Robust connector head with 6 or 12 Q-ODC jacks
- Rodent protection and UV-resistant
- Simple, time-saving installation

Applications

- Control cabinet cabling in and between buildings
- For connecting distribution boxes
- For connecting access points on masts or in buildings



MASTERLINE Extreme

- Featuring robust ODC industrial connectors
- Safe installation – blind mating
- Water- and dust-tight for use in tough environmental conditions
- Hybrid version with power conductor available

Applications

- Control cabinet cabling in and between buildings
- For connecting distribution boxes
- For connecting access points on masts



MASTERLINE Classic

- Strong cable support
- Wide operating temperature range
- Dust- and water-tight pull-in hose for protecting fan-out cables
- With standard connectors

Applications

- Control cabinet cabling in and between buildings
- For connecting distribution boxes and cabinets
- For cabling communication networks

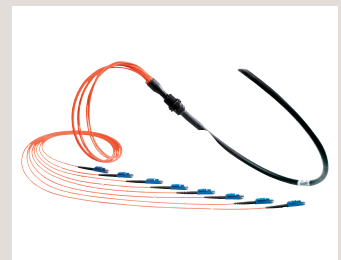

Mobile cable systems

- Easy storage of cable assemblies
- Assemblies with multi-pole connectors
- MASTERLINE Mobile with standard connectors and removable protective sheaths
- Both cable ends accessible

Applications

- Temporary connections



Fiber optic fiber management systems

Practical and compact modules support the professional fanning out of fibers to connection and fan-out points.

MDR module

- Space saving
- Mounted on DIN rail (35 mm)
- Splice/patch and patch variants
- Angled couplings for optimal patch cable connections

Applications

- Fiber fan-out in control cabinets and distribution boxes

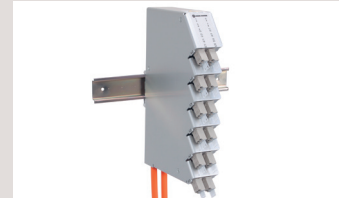

Wall-mounted housings

- Various sizes (Optibox)
- For splicing and/or patching
- Multiple cable inputs and outputs
- High level of dust- and water-tightness
- Smart fiber management

Applications

- For connecting cable segments
- Branch point to access points
- For use in buildings and outdoors



Cable terminations

- Housings for splicing and patching
- For 19" cabinets
- Easy installation
- Casing also available for housing fan-out cables in cable systems

Applications

- Fiber fan-out in control cabinets, distribution boxes and distribution cabinets

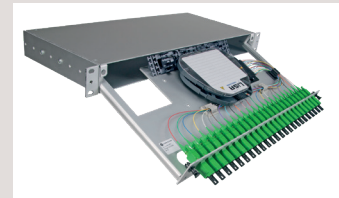

Distribution boxes

- High fiber density
- Optimum access to fibers and connectors
- Modular assembly for future expansion

Applications

- For connecting and branching cable segments
- For connecting access points
- For use in buildings and outdoors



Distribution enclosures

- Optimum access to fibers and connectors
- Splice and patch-only modules and splice/patch modules
- Modular assembly for gradual expansion
- Professional fiber and cable supports

Applications

- Fiber distribution in communication network nodes



Wavelength Division Multiplexing (WDM)

HUBER+SUHNER has specialized on optical wavelength division multiplexing. We offer all types of optical muxes, ranging from simple Wideband WDM over Coarse WDM to Dense WDM. To be able to combine the different WDM grids and/or cascade several muxes we have provide the matching WDM bandsplitters. There is no grid that we do not serve, so of course we as well offer the muxes that power high-speed multi-lambda transceivers and we are happy to customize our muxes to your specific grids applied in your sensing application.

CWDM COLOR cubes

Coarse Wavelength Division Multiplexing (CWDM) is an excellent choice for increasing bandwidth capacity while keeping costs down. The COLOR cube family, based on standard Thin Film Filter (TFF) technology with a proprietary packaging, offers you smallest component dimensions combined with an outstanding performance and reliability.



Bandsplitter COLOR-Cubes

HUBER+SUHNER provides a great variety of hi-isolation bandsplitters, based on Thin Film Filters (TFF): Simple Wideband WDMs which create two channels at 1310 and 1550 nm, each with a bandwidth up to 100 nm. Or different CWDM bandsplitters for CWDM upgrades and extensions from e.g. 4 channels to 8 channels. Here, an important characteristic is the number of skipped (not-useable) channels, reaching from 0 to 2 channels.



DWDM COLOR cubes

While we use our patented packaging and assembly technology for the wider WDM grids, we as well rely on classical cascading of 3-ports assembled into modules for the narrow DWDM grids. We can supply any combinations and channel amounts, ranging from 400 to 50 GHz, please, contact us for further configurations.

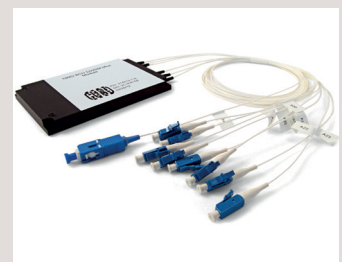

All-optical switches

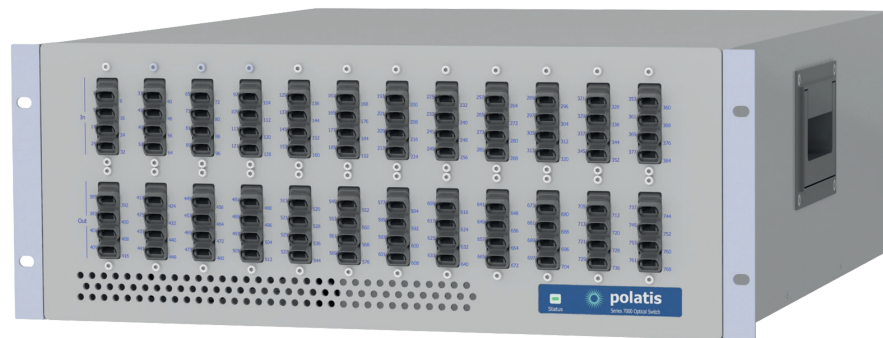

HUBER+SUHNER Polatis is the leading provider of all-optical switches, enabling low latency, fully transparent connections between optical fibers without requiring conversion between optical and electrical signals to offer much greater flexibility and energy efficiency. The patented Direct-Light® optical switch technology connects fibers with the best possible optical performance. The modular, strictly non-blocking optical switch platform scales from 4 × 4 to 384 × 384 ports, applying class-leading performance to provide dynamic connectivity for government, data center, test, telecommunications and video networks.

Polatis all-optical switches are time-proven in mission-critical government, aerospace and defense applications, with key features that enable systems integrators to deliver the secure, scalable, reliable, manageable and cost-effective optical cross-connect capabilities that government agencies require for both digital and analogue communications networks.

System components

Series 1000

- Benchmark optical performance
- Rich user interface functionality
- Single sided N-fibre variants available
- Verizon NEBS 3+ certified

Series 3000

- DirectLight Multimode System
- Supports 50/125 and 62.5/125 multimode fiber
- Available in N x N, M x N configurations NETCONF

Series 6000 Lite

- Compact 1RU physical size
- Energy efficient, low power, fanless
- Redundant hot swap NIC + PSU
- SDN enabled with OpenFlow and NETCONF

Series 6000

- Low insertion loss/superior optical specs
- Carrier class interfaces
- Available in N x N and M x N configurations
- Single sided variants available

Series 6000 PSS

- Compact 1+1 optical layer protection
- Up to 16 services in 1RU, < 25 W
- Pre-configured, drop in APS system
- Automatic LOS protection and restoration

Series 7000

- Superior optical specs
- N x N and M x N configurations
- SDN enabled carrier-class interfaces
- Low power, resilient architecture

Applications



RF-over-Fiber

HUBER+SUHNER Polatis' switches enable government agencies to use optical fiber to eliminate copper coaxial cabling, copper based patch panels, and large footprint RF switches to distribute RF signals within buildings, satellite ground terminals, mobile command shelters, land, sea and airborne platforms and test ranges.

> page 142



Data center/cyber security

The HUBER+SUHNER Polatis optical switch can be seamlessly integrated with software-defined network management and orchestration agents, allowing commissioning, change, or upgrade of optical resources with just a few mouse clicks.

> page 142



Remote software-defined test access

Unlike many traditional optical solutions, a HUBER+SUHNER Polatis optical switch enables seamless, centralized test equipment integration and enables agencies to leverage expensive test equipment across their optical infrastructure. Furthermore, the high performance of the HUBER+SUHNER Polatis optical switch ensures that test data is accurate, reliable and repeatable.

> page 143

Technology

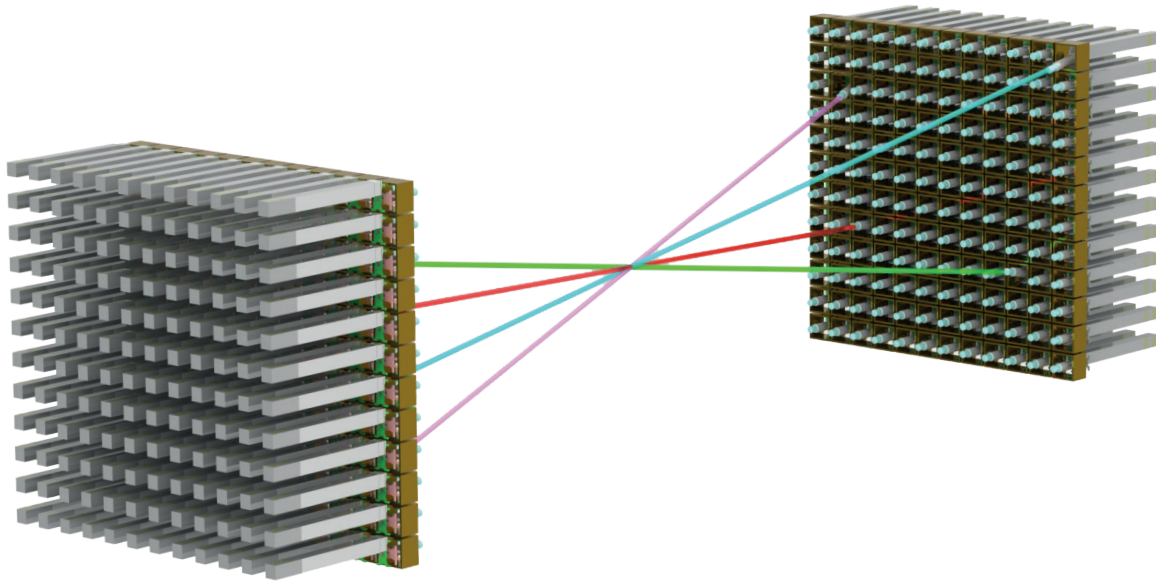

Polatis' highly reliable piezoelectric Directlight® beam-steering technology sets the industry standard for lowest optical loss and highest performance. With more than a billion port-hours accumulated on deployed units, the Polatis technology platform delivers a broad range of class-leading all-optical matrix switch products into demanding applications.

At the core of Polatis optical switches is our patented DirectLight beam-steering technology that makes connections using compact piezoelectric actuators to align collimated beams of light from opposing arrays of input and output fibers with minimal loss, distortion or interference between paths. Alignment is maintained using feedback from integrated position sensors to ensure connection stability over time, temperature and external disturbances. Switching occurs completely independently of the power level, color or direction of light on the path, enabling pre-provisioning of dark fiber and avoiding concatenation of switching delays across mesh or multi-stage switched optical networks. Polatis optical switches are fully non-blocking and available in sizes from 4×4 to 384×384 .

Key features

- DirectLight® free-space optical switch technology connects fibers with the best possible optical performance
- Lowest loss all-optical cross-connect – typical 1 dB IL
- Excellent connection repeatability and stability
- Modular platform scales from 4×4 thru 384×384 and beyond
- Dual-sided (M \times N) and single-sided (M-fibre) variants
- True transparent dark-fibre switch connections are independent of protocol, bitrate, light colour, direction or power level
- Robust against shock, vibration, thermal environments
- Optical power monitoring enables variable attenuation and M:N optical layer mesh protection switching

Product overview

Product	Matrix size	Technology	Optional functions	
Series 1000	4 × 4 to 32 × 32 32-fiber	DirectLight™ Singlemode	OPM APS VOA	<ul style="list-style-type: none"> Benchmark optical performance Rich user interface functionality Single sided N-fibre variants available Verizon NEBS 3+ certified
Series 3000	4 × 4 to 16 × 16	DirectLight™ Multimode	OPM APS VOA	<ul style="list-style-type: none"> Supports 50/125 and 62.5/125 Multimode fiber Available in N × N, M × N configurations Touchscreen
Series 6000 Lite	Up to 48 × 48	DirectLight™ Singlemode	OPM APS VOA	<ul style="list-style-type: none"> Compact 1RU physical size Energy efficient, low power, fanless Redundant hot swap NIC and PSU SDN enabled with OpenFlow and NETCONF
Series 6000	48 × 48 to 192 × 192 192-fiber	DirectLight™ Singlemode	OPM APS VOA	<ul style="list-style-type: none"> Low insertion loss/superior optical specs Carrier class interfaces (SNMP, TL1, etc.) Available in N × N and M × N configurations Single sided N-fibre variants available SDN enabled with OpenFlow and NETCONF
Series 6000 PSS	4, 8 or 16 Rx/Tx line pairs Protection services	DirectLight™ Singlemode		<ul style="list-style-type: none"> Compact 1+1 optical layer protection Up to 16 services in 1RU, < 25 watts Pre-configured, drop in APS system Automatic LOS protection and restoration
Series 7000	208 × 208 to 384 × 384	DirectLight™ Singlemode	OPM APS VOA	<ul style="list-style-type: none"> Superior optical specs N × N and M × N configurations SDN enabled carrier-class interfaces Low poer, resilient architecture

OPM: Optical power monitor/APS: Automatic protection switching/VOA: Variable optical attenuation

Configuration options

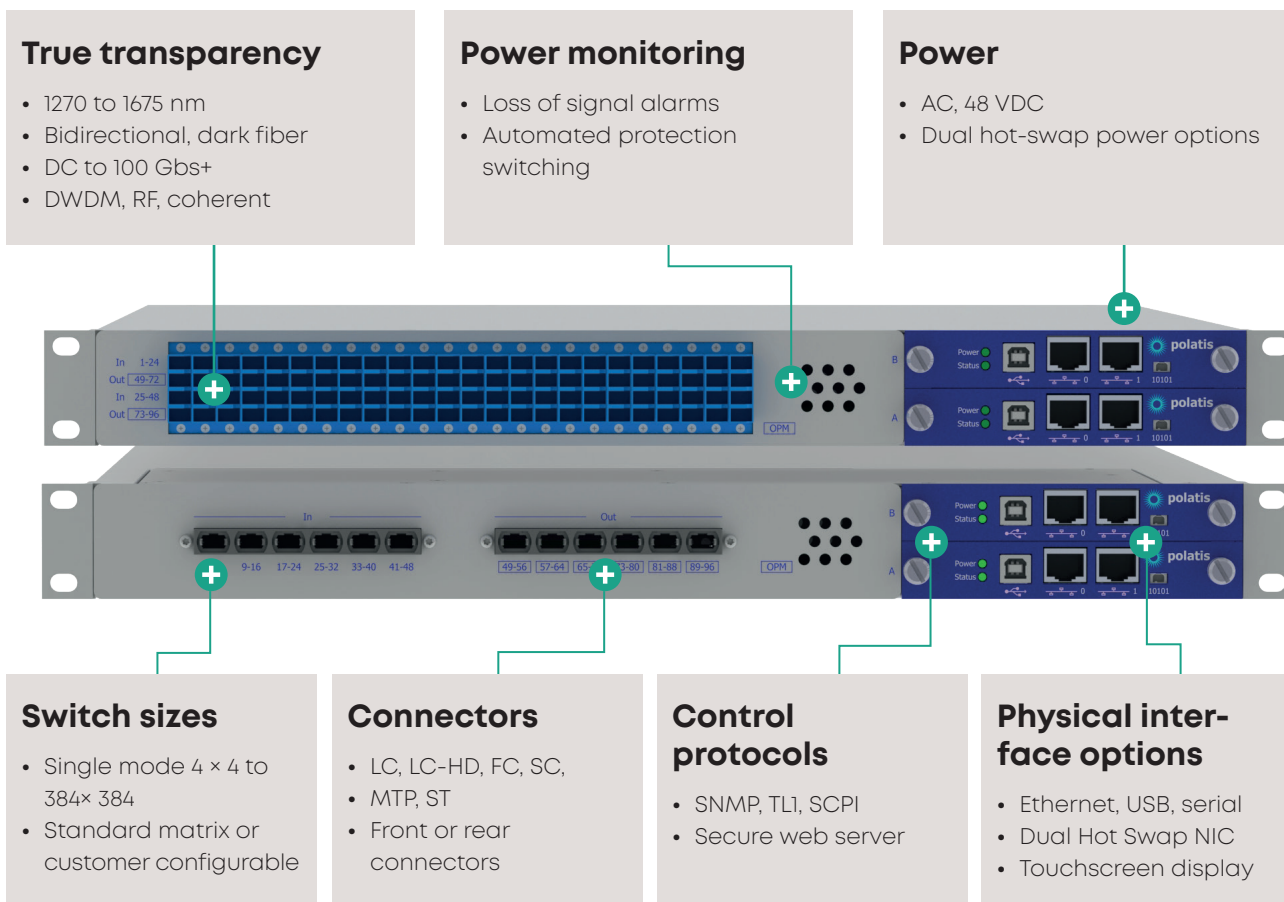

Applications



RF-over-Fiber

Distribution of RF signals over fiber has been established since the mid 1980's for cable TV, government and defence related applications. The well-documented benefits of distributing RF signals through optical fibers rather than coaxial copper cable include greatly reduced electromagnetic interference and susceptibility, smaller and less expensive cables with lower attenuation, better RF link noise performance and longer cable runs.

HUBER+SUHNER Polatis all-optical switches have found significant applications in RF distribution systems for flexible provisioning and protection of fiber links and terminal equipment. Performance differentiators of the Polatis optical switch technology include ultra-low optical loss, typically below 1 dB; modulation-free dark fiber connectivity, low crosstalk and polarization dependence, high signal security and low optical back reflection.

HUBER+SUHNER Polatis' switches enable government agencies to use optical fiber to eliminate copper coaxial cabling, copper based patch panels, and large footprint RF switches to distribute RF signals within buildings, satellite ground terminals, mobile command shelters, land, sea and airborne platforms and test ranges. Using fiber optics for RF distribution allows systems to support secure communications across Secure Compartmented Information Facility (SCIF) boundaries.



Data center and cyber security

Traditional fiber optic distribution systems rely on manual intervention to provision connections. Automation of the fiber infrastructure to create a software-defined optical network eliminates the delay, error and uncertainty of manual provisioning and removes a potential weak link in the information security structure. Using the Polatis dynamic fiber cross-connects, government agencies can reduce service provisioning and upgrade timescales and manual service intervention requirements by up to 90 %.

The Polatis optical switch can be seamlessly integrated with software-defined network management and orchestration agents, allowing commissioning, change, or upgrade of optical resources with just a few mouse clicks. Automated provisioning not only reduces the potential for human error, it also eliminates the handling of fibers and connectors, significantly increasing the life of the fiber plant and improving system return on investment.

Applications

Remote software-defined test access

Unlike many traditional optical solutions, a HUBER+SUHNER Polatis optical switch enables seamless, centralized test equipment integration. Using Polatis enables agencies to leverage expensive test equipment across their optical infrastructure to:

- Reconfigure and partition system connectivity on demand between multiple users
- Improve network reliability and availability through more rapid fault isolation and remediation
- Coordinate fault location with an up-to-date database to ensure that the right network resources are rapidly repaired
- Perform maintenance and service restoration on a fiber-by-fiber basis, without impact to other fibers or services

Furthermore, the high performance of the Polatis optical switch ensures that test data is accurate, reliable and repeatable. HUBER+SUHNER Polatis' ability to incorporate real-time tests into the fabric of the optical network improves not only the reliability of the communications infrastructure; it also drives down operational costs through „onestop“ system testing. And, by improving fault isolation and remediation, on-site maintenance requirements (and their costs) are drastically reduced.



RF-over-Fiber series (RFoF, GPSoF and LANoF)

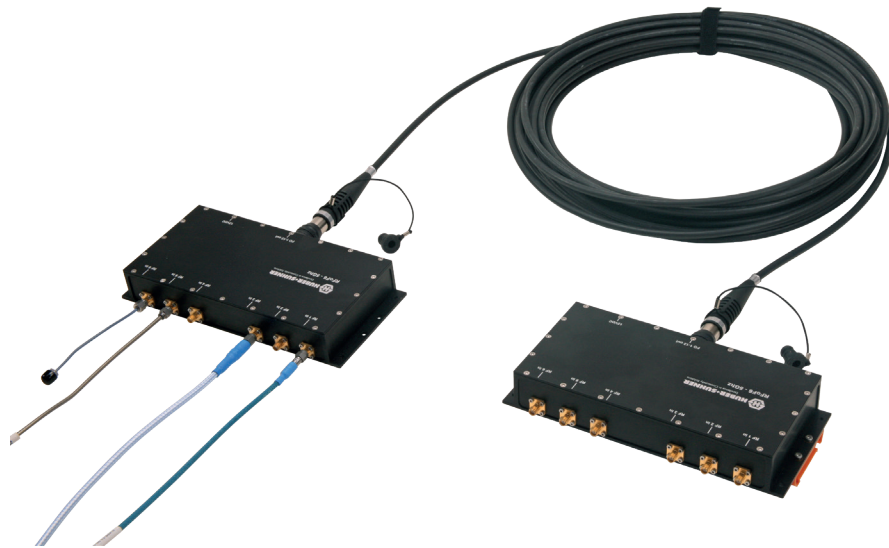

The market is evolving at a significant pace. With customers requiring that new systems combine various technologies, HUBER+SUHNER has positioned itself to be able to provide customers with end-to-end hybrid solutions.

The RF-over-Fiber series enables the use of radio frequency and fiber optics in a single system. With these two core technologies, HUBER+SUHNER is using its vast experience and expertise to deliver best-in-class technology conversion modules.

HUBER+SUHNER's RF-over-Fiber series consists of three product lines; RF-over-Fiber (RFoF), GPS-over-Fiber (GPSoF) and LAN-over-Fiber (LANoF).

The main advantages that RF-over-Fiber systems have over traditional RF system are that they:

- allow for greater distances between the RF source and the RF receiver system
- are immune to EMI and RFI
- are immune to EMP
- are more difficult to intercept („tap“)
- are lighter in weight

System components

RF-over-Fiber (RFoF)

- 1 MHz to 20 GHz
- Simplex and duplex systems
- Fully configurable

GPS-over-Fiber (GPSoF)

- L1 and L2 bands
- Multipoint receivers
- 1PPS and 10 MHz

LAN-over-Fiber (LANoF)

- Gigabit connectivity
- „Field LAN“ ruggedized
- Up to 20 km per link

Applications



Shelters

Highly mobile and deployed in harsh environments, connectivity as well as the safety of the command center are key aspects of RF-over-Fiber within an antenna remoting system. The use of fiber optic cables makes it possible to position the shelters further away from the antennas and contributes to high mobility.
> page 153



Vehicles

GPS-over-Fiber enables a single GPS signal to be distributed into multiple receiver systems. The small form factor adds significant value within the vehicle with both the conversion modules and fiber optic cable designed to use as little space as possible.
> page 154

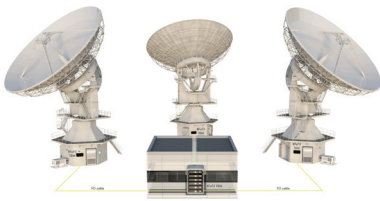

SATCOM

Highly mobile and deployed in harsh environments, connectivity as well as the safety of the command center are key aspects of RF-over-Fiber within an antenna remoting system. The use of fiber optic cables makes it possible to position the shelters further away from the antennas and contributes to high mobility.
> page 155



Aircraft

High density RF connectivity with a significantly reduced cable footprint is key to the success of the HUBER+SUHNER airframe solution. Weight reduction and cost optimization are achieved by using less material as well as speeding up the installation and maintenance processes.
> page 156



Naval Vessels

RF-over-Fiber within naval applications covers both communication systems on the vessel as well as antenna systems relevant to missions. The use of RF-over-Fiber and LAN-over-Fiber ensures ruggedized end-to-end solutions on all communication platforms.
> page 157

RF-over-Fiber

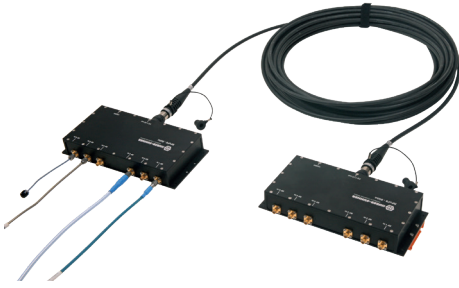

Driven by a philosophy of providing high density RF connectivity, while significantly reducing cable footprints, HUBER+SUHNER's single mode, simplex and duplex systems are both flexible and perfect for harsh environments. Flexibility is achieved by providing customers with a wide range of options when it comes to inter-connectivity, while the scalability of the systems enables an unlimited RF connectivity density.

The use of HUBER+SUHNER's renowned components, such as RADOX and Q-ODC-12, ensures that the system can be deployed in any environment and with a significantly smaller cable footprint.

The standard RFoF modules are available in 1, 6 and 12 ports and cover a wide frequency range of 1 MHz to 20 GHz. The systems are capable of covering distances of up to 100 km and are perfect for applications requiring secure, low loss, light-weight and high density connectivity.

RF-over-Fiber		# of RF ports				Key technical parameters/features									
Item	Item description	1	3	6	12	Simplex	Duplex	Frequency MHz		Gain flatness*	Noise figure*	SFDR*	OIP3*	Single-mode	Max. link distance**
								from	to	dB/100 MHz	dB	dB Hz ^{2/3}	dBm		
85073881	RFoF1 – 3 GHz (TX)	·				·		1	3000	< 1.5	15	100	20	·	100
85073882	RFoF1 – 3 GHz (RX)	·				·		1	3000	< 1.5	15	100	20	·	100
85073883	RFoF1 – 3 GHz (TRM)	·				·		1	3000	< 1.5	15	100	20	·	100
85071061	RFoF6 – 3 GHz (TX)		·				·	1	3000	< 1.5	15	100	20	·	100
85071062	RFoF6 – 3 GHz (RX)		·				·	1	3000	< 1.5	15	100	20	·	100
85071063	RFoF12 – 3 GHz (TX)			·	·			1	3000	< 1.5	15	100	20	·	100
85071064	RFoF12 – 3 GHz (RX)			·	·			1	3000	< 1.5	15	100	20	·	100
85071065	RFoF3 – 3 GHz (TRM)		·				·	1	3000	< 1.5	15	100	20	·	100
85071066	RFoF6 – 3 GHz (TRM)		·				·	1	3000	< 1.5	15	100	20	·	100
85065392	RFoF6 – 6 GHz (TX)		·					300	6000	< 1.5	20	100	10	·	100
85065393	RFoF6 – 6 GHz (RX)		·					300	6000	< 1.5	20	100	10	·	100
85074581	RFoF6 – 6 GHz LN (TX)		·					300	6000	< 0.7	7	105	10	·	100
85074578	RFoF6 – 6 GHz LN (RX)		·					300	6000	< 0.7	7	105	10	·	100
85065394	RFoF12 – 6 GHz (TX)			·	·			300	6000	< 1.5	20	100	10	·	100
85065395	RFoF12 – 6 GHz (RX)			·	·			300	6000	< 1.5	20	100	10	·	100
85071630	RFoF3 – 6 GHz (TRM)		·				·	300	6000	< 1.5	20	100	10	·	100
85071631	RFoF6 – 6 GHz (TRM)		·				·	300	6000	< 1.5	20	100	10	·	100
85072903	RFoF1 – 20 GHz (TX)	·				·		200	20 000	< 1.0	45	100	28	·	100
85072904	RFoF1 – 20 GHz (RX)	·				·		200	20 000	< 1.0	45	100	28	·	100
85076291	RFoF1 – 20 GHz (TRM)	·				·		200	20 000	< 1.0	45	100	28	·	100
85077808	RFoF1 – 20 GHz LN (TX)	·				·		200	20 000	< 1.0	8	105	25	·	100
85077809	RFoF1 – 20 GHz LN (RX)	·				·		200	20 000	< 1.0	8	105	25	·	100

* Typical value(s)

** Real link distances are dependent on the application/environment.

Datasheet RFoF6 – 3 GHz

Electrical data		Value			Remarks
		minimal	typical	maximal	
Frequency range	MHz	1		3000	3 dB bandwidth
Gain	dB	6	10	14	
Gain flatness	dB/100 MHz		< 1.5		
Noise figure	dB	12	15	25	
Spurious-free dynamic range	dB Hz ^{2/3}		100		
Max. input at 1dB compression	dBm		+0		
Max. input power for no damage	dBm		+15		
VSWR (input and output)	dB		< 1.8		
OIP3	dBm		+20		
Time delay	Ns		12		
Supply voltage transmitter	VDC	+11	+12	+16	max. 750 mA
Supply voltage receiver	VDC	+11	+12	+16	max. 500 mA
Temperature range	operating	°C	-40	+85	
	storage	°C	-40	+85	
RF input impedance	Ω	50			

Optical Data		Value			Remarks
		minimal	typical	maximal	
Fiber optic connectors		Q-ODC 12			
Fiber		Single mode fiber 9/125 um			
Fiber power loss	dB/km		0.4		
Optical power in fiber	mW	3	6	10	
Side mode suppression ratio	dB	30	40		

Mechanical Data		Value	Remarks
Module weight	kg	1.1	transmitter and receiver
Module dimensions	mm	220 × 100 × 34	transmitter and receiver
RF connectors		QMA/SMA female	

All specifications at 25 °C case temperature Tc, unless otherwise specified.

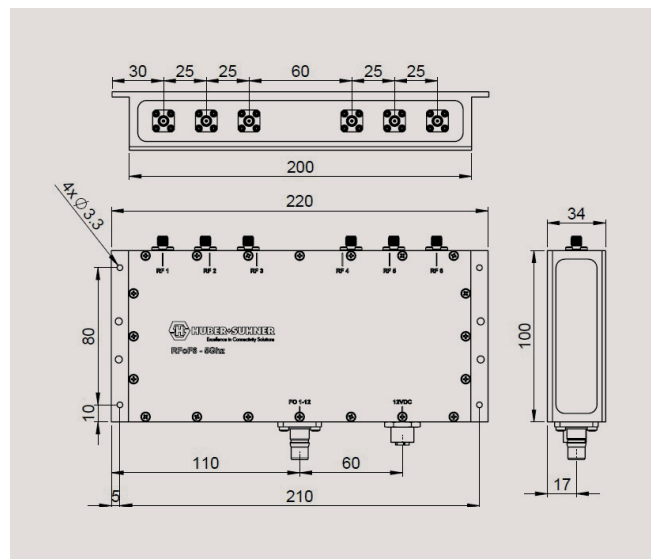

GPS-over-Fiber (GPSoF)

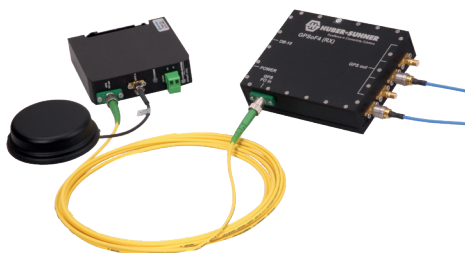

Our GPSoF modules are focused on distributing a single GPS signal into multiple receiver systems. This approach ensures that signal data, such as time synchronization into separate, yet connected, systems is always the same. Standard GPSoF systems include both single and multiport solutions; and accommodate both L1 and L2 bands.

In addition to the GPSoF modules, HUBER+SUHNER also provides a Time and Frequency Standard (TFS) module. This module uses 1PPS to ensure that time synchronization is still possible in the event of a loss of GPS signal. The pulse is synchronized to the average of the GPS signal. The module also provides a 10 MHz electrical output, which is used for reference signaling. The small form factor of the GPSoF modules ensures that the systems are ideal for both fixed and mobile applications, where space may be limited.

GPS-over-Fiber		# of RF ports		Key technical parameters/features										
Item	Item description	1	4	Simplex	Frequency MHz		Gain flatness*	Noise figure*	SFDR*	OIP3*	1PPS	10 MHz	Single-mode	Max. link distance**
					from	to	dB/100 MHz	dB	dB Hz ^{2/3}	dBm				km
85065409	GPSoF1 – 1.5 GHz (TX)	.	.	.	1565	1615	< 2.0	14	100	7	.	.	.	100
85065397	GPSoF1 – 1.5 GHz (RX)	.	.	.	1565	1615	< 2.0	14	100	7	.	.	.	100
85065809	GPSoF4 – 1.5 GHz (RX)	.	.	.	1565	1615	< 2.0	14	100	7	.	.	.	100
85072905	GPSoF1 – 1.5 GHz (TX) L1+L2	.	.	.	1218	1615	< 2.0	14	100	7	.	.	.	100
85072906	GPSoF1 – 1.5 GHz (RX) L1+L2	.	.	.	1218	1615	< 2.0	14	100	7	.	.	.	100
85072907	GPSoF4 – 1.5 GHz (RX) L1+L2	.	.	.	1218	1615	< 2.0	14	100	7	.	.	.	100
85072918	TFS1.10	.	.	.	1218	1615	N/A	N/A	N/A	N/A	.	.	.	100
85072919	GPSoF4+ (RX)	.	.	.	1218	1615	<2.0	14	100	7	.	.	.	100

* Typical value(s)

** Real link distances are dependent on the application/environment.

Datasheet GPSoF – 1.5 GHz (L1+L2)

Electrical data		Value			Remarks
		minimal	typical	maximal	
Frequency range	MHz	1218		1615	
Gain	dB	4	7	10	
Gain flatness	dB/100 MHz		< 2		
Noise figure	dB		14		
Spurious-free dynamic range	dB Hz ^{2/3}		100		
Max. input at 1dB compression	dBm		-20		
Max. input power for no damage	dBm		+15		
VSWR (input and output)	dB		< 1.8		
OIP3	dBm		+ 7		
Time Delay	Ns		55		
Supply voltage Vs transmitter	VDC	+12	+12	+15	max. 170 mA
Supply voltage Vs receiver	VDC	+12	+12	+15	max. 100 mA
Temperature range	operating	°C	-40	+85	
	storage	°C	-40	+85	
RF input impedance	Ω	50			

Optical data		Value			Remarks
		minimal	typical	maximal	
Fiber optic connectors		FC/APC			
Fiber		Single mode fiber 9/125 um			
Optical power in fiber	mW	6	8	10	
Side mode suppression ratio	dB	30	40		

Mechanical data		Value			Remarks
		minimal	typical	maximal	
Module weight	g	270			transmitter and receiver
Module dimensions	mm	90 × 95 × 23			transmitter and receiver
RF connectors		QMA/SMA female			

All specifications at 25 °C case temperature Tc, unless otherwise specified.

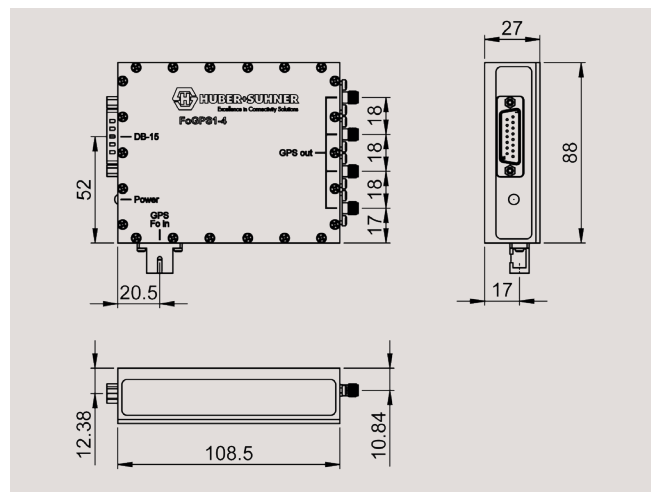

LAN-over-Fiber



With the use of multimedia continuing to increase within the operations landscape (from planning to de-briefing), our modules are focused on providing Gigabit connectivity within challenging environments.

Again, the use of HUBER+SUHNER's RADOX and Q-ODC-12 components ensure that the exposed portions of the system remain functional within harsh environments, while the interconnect within a mobile structure (shelter or vehicle) remains robust and functional within environments exposed to, for example, intense vibration.

The standard LAnoF modules are available in 1, 6 and 12 ports and can be easily integrated into existing network infrastructures. The LAnoF system is particularly well suited to applications that require „field LAN“ capabilities for data synchronization, diagnostics, remote identification and software distribution.

LAN-over-Fiber		# of LAN ports			Key technical parameters/features				
Item	Item description	1	6	12	Duplex	Bit rate		Single mode	Max. link distance **
						from	to		
						Mbps	Mbps		km
85072917	LAnoF1 – 1 Gbps	.			.	10	1000	.	20
85065410	LAnoF6 – 1 Gbps		.		.	10	1000	.	20
85065411	LAnoF12 – 1 Gbps			.	.	10	1000	.	20

** Real link distances are dependent on the application/environment.

Datasheet: LANoF6 – 1 Gbps

Electrical data		Value			Remarks
		minimal	typical	maximal	
Data rate	Mbps	10		1000	
Max. distance	km			20	
Max. optical input power for no damage	dBm		+15		
Supply voltage Vs	VDC	+12	+12	+32	max. 100 mA
Temperature range	operating storage	°C °C	0 -40	+70 +85	

Optical data		Value			Remarks
		minimal	typical	maximal	
Fiber optic connectors		Q-ODC-12			
Fiber		Single mode fiber 9/125 um			
Fiber power loss	dB/km		0.4		
Optical power in fiber	mW	3	6	10	
Side mode suppression ratio	dB	30	40		

Mechanical data		Value			Remarks
		minimal	typical	maximal	
Module weight	kg	1.3			transmitter and receiver
Module dimensions	mm	270 × 150 × 90			transmitter and receiver
LAN connectors		RJ45/M12 P4			

All specifications at 25 °C case temperature Tc, unless otherwise specified

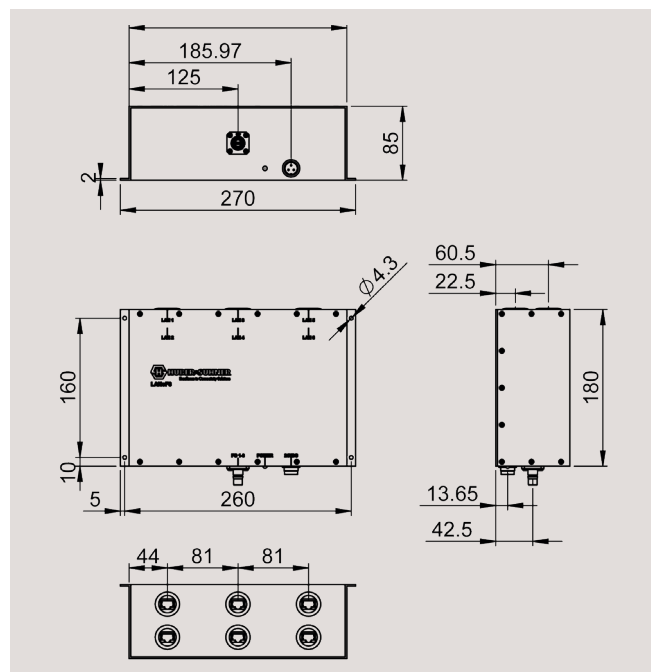

Customized modules

The modular design of the RF-over-Fiber series products ensures that HUBER+SUHNER is able to provide fast, flexible and cost-effective customizations that meet our customers' application requirements.

Customized options include

- Small-form factor for applications that have limited space available
- Housings that support the light-weighting requirements of an application
- A combination of RF, GPS and LAN functionality into a single module
- Ruggedization for use in harsh environments (i.e. extreme temperatures, vibration and shock)
- High-density housing for applications that need to limit the amount of hardware within the solution without compromising on connectivity density
- Customer-specific interconnect options (for both RF and FO)
- Rack-mountable housing

Small form factor

- Housings that support the light-weighting requirements of an application
- Small-form factor for applications that have limited space available



Combined technologies

- Rack-mountable housing
- A combination of RF, GPS and LAN functionality into a single module



Ruggedized enclosures

- Rack-mountable and high-density housing
- Ruggedization for use in harsh environments (i.e. extreme temperatures, vibration and shock)



Key application: Shelters

(Makes use of RFoF, GPSoF and LANoF)

Shelter connectivity perfectly illustrates the benefits of an RF-over-Fiber system. Highly mobile and deployed in harsh environments, connectivity as well as the safety of the control center are key elements of RF-over-Fiber within an antenna remoting system.

The use of FO cables, within a traditional RF system, makes it possible to position the shelters far away from the antennas, while ensuring that the links between the antennas and the shelter remain secure.

The use of FO cables also supports the mobility of the application by reducing the cable footprint as well as light-weighting the solution. This dramatically simplifies and speeds up the installation and maintenance of the system. The use of HUBER+SUHNER's RADOX® technology ensures superior performance in harsh environments. Immunity to EMI, EMP and RFI provide the important finishing touches to this high performing and secure system solution.

In addition to the RF-over-Fiber solution, HUBER+SUHNER offers any additional connectivity requirements within a shelter. Our antennas, lightning protectors and military qualified cable assemblies are well-known and widely used in defense applications worldwide.

Key benefits

- **Safety** Enables greater distances between the shelter personnel and the RF equipment.
- **Security** Immune to EMI and RFI. Lower risk of interception.
- **Better performance** Greater distances covered with very low loss.
- **Ruggedized** Designed for use in harsh environments.
- **Mobility** Light-weighting and reduction of cable footprint enable rapid deployment.



Key application: Vehicles

(Makes use of GPSoF and LANoF)

RF-over-Fiber is creating new opportunities for cabled solutions within vehicle applications. Highly mobile and exposed to challenging environments, the RF-over-Fiber series is paving the way for the next generation of end-to-end connectivity solutions in this application landscape.

GPS-over-Fiber enables a single GPS signal to be distributed into multiple receiver systems. The small form factor adds significant value within the vehicle with both the conversion modules and FO cable designed to use as little space as possible, while eliminating all forms of (EM and RF) interference.

LAN-over-Fiber facilitates vehicle identification as well as data and software synchronization for vehicles that are deployed in the field. This new „field LAN“ capability, based on a ruggedized gigabit FO network is changing the way that media and data is being shared in operations.

Key benefits

- **Mobility** Reduction of cable footprint enables rapid deployment.
- **Form factor** Small modules and cables ensure easy integration.
- **Better performance** „Field LAN“ is a game changer. GPS signal distribution is smarter.
- **Security** Immune to EMI/RFI. Lower risk of interception.
- **Ruggedized** Designed for use in harsh environments.



Key application: SATCOM

(Makes use of RFoF and LANoF)

In SATCOM applications, RF-over-Fiber enables communication between satellites and control centers. The communication link is created by connecting the antenna to the control center. RF-over-Fiber supports both fixed earth installations as well as mobile applications.

Broad frequency ranges, excellent performance and security are critical aspects that are perfectly addressed by HUBER+SUHNER's RF-over-Fiber products. With single modules that cover the all intermediate frequency (IF) signals as well as the L, S and C bands, HUBER+SUHNER not only meets the frequency range requirements in SATCOM, but also has low noise modules in its portfolio that can be used in noise-sensitive applications. The low noise modules offer a 50 % lower noise figure, from 15 dB to 7 dB (IF signals).

Excellent performance and the security of the SATCOM links are further supported by immunity to EMI, RFI and EMP.

The use of LAN-over-Fiber is growing within the SATCOM applications landscape. Ethernet connectivity for VOIP, VPN connectivity and other data network services are easily integrated into both fixed and mobile infrastructures. Gigabit LAN modules ensure the future-proofing of all SATCOM applications.

Key benefits

- **Security** Immune to EMI and RFI. Lower risk of interception.
- **Better performance** Greater distances covered, immune to EMP and very low loss.
- **Mobility** Less cable and weight supports rapid deployment in mobile applications.
- **Efficient** Faster and simplified installation and maintenance (key in mobile applications – SNG and VSAT)

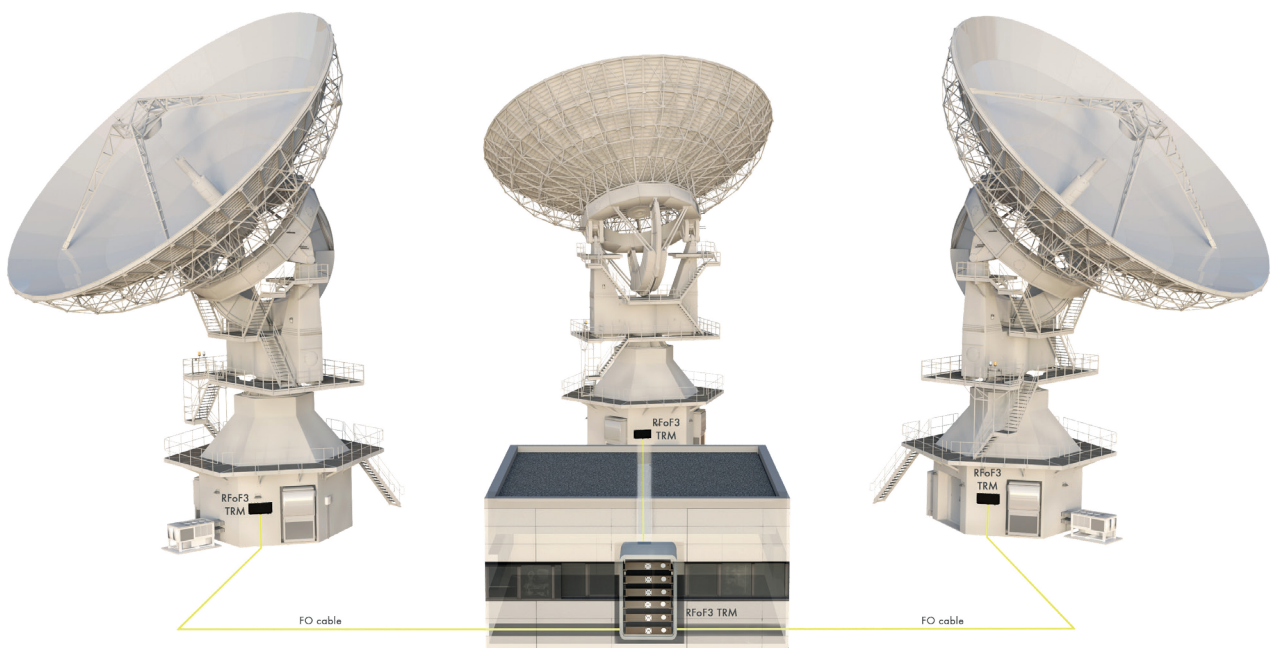

Key application: Aircraft

(Makes use of RFoF)

The integration of RF-over-Fiber solutions within airframe applications is growing rapidly. High density RF connectivity and lightweighting are key elements that are optimally addressed by RF-over-Fiber. Often requiring dozens of RF connections between various sensors, antennas and systems, the HUBER+SUHNER RF-over-Fiber products provide flexibility by ensuring that the solution is easily scalable.

For example, the use of five 12 port modules easily covers the requirement of 50 RF connections; and providing reserve capacity for future connectivity increases. The use of five modules means that only five cables are required to cover the entire connectivity demand. This not only significantly decreases the overall cable footprint, but allows for meaningful weight reduction within the aircraft.

The light-weighting of the connectivity solution while retaining optimal performance, allows for the weight to be used elsewhere else in the aircraft or for the total weight of the aircraft to be reduced. The reduction of the weight of the aircraft offers better fuel efficiency, which can either save costs or provides the capability to extend the time and range of a mission.

Key benefits

- **Scalability** Perfect for applications requiring a high density of RF connectivity.
- **Better performance** Significantly less loss.
- **Efficient** Less cable means faster and easier installation and maintenance.
- **Lightweight** Saves costs or allows for weight re-distribution.
- **Security** Immune to EMI and RFI.
- **Ruggedized** Designed for use in airborne conditions.

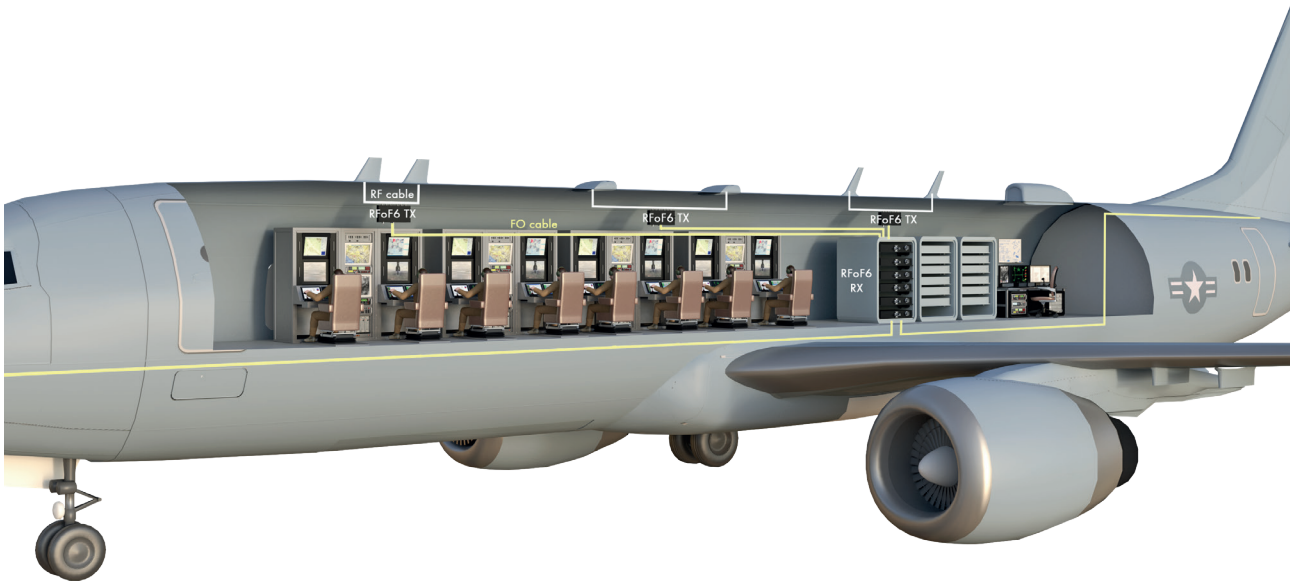

Key application: Naval Vessels

(Makes use of RFoF, GPSoF and LANoF)

„A city on the sea“, naval applications have both a requirement for intra-vessel communication and networking systems; as well as mission-relevant systems.

The density of connectivity as well as the distances between the RF equipment and the receiver systems, make the RF-over-Fiber series ideal for naval applications.

The easily scalable RF-over-Fiber products ensure that the RF density requirements are met, while still reducing the overall cable footprint on the vessel. The broad frequency range also ensures that the RF-over-Fiber modules can be used for navigation, INMARSAT, COMINT, ELINT and other antenna systems.

The use of LAN-over-Fiber provides a ruggedized Gigabit FO network on the vessel.

Key benefits

- **Scalability** Perfect for applications requiring a high density of RF connectivity.
- **Utility** Covers both internal and mission-relevant systems.
- **Efficient** Less cable means faster and easier installation and maintenance.
- **Security** Immune to EMI and RFI.
- **Ruggedized** Designed for use in harsh environments.



System solutions



System products

With the market rapidly moving to **combine technologies and to increase connectivity density**, our growing system product portfolios provide the bridges for the delivery of end-to-end solutions.

Services

HUBER+SUHNER's **global supply chain network and engineering footprint** enables us to provide our customers with a one-stop-stop for their service needs. Our servicing offering includes kitting, painted antennas, sourcing, project management and other value-adding services.

Sub-systems

Excellence in engineering and manufacturing provides the basis for delivering added value to our customers within the sub-systems area. HUBER+SUHNER is **perfectly positioned to deliver hybrid, multi-product and build-to-print solutions**.

Systems

The nature of systems developments and Implementations requires global **project excellence** along with a focus on delivering solutions instead of components. Our **turn-key solution approach** (which combines project management, solution design capabilities and high performing products) is a key differentiator in this fastgrowing area of our business.

System solutions – examples

Cable solutions

With radio frequency, low frequency and fiber optic technologies all core competencies of HUBER+SUHNER, we are able to provide a host of harnessing and hybrid assembly cable solutions.



Antenna systems

HUBER+SUHNER's extensive range of antennas provides an ideal platform for delivering best-in-class communication and jamming systems. Flexible configuration options that include systems-level testing provide the finishing touches to this fast-growing offering.

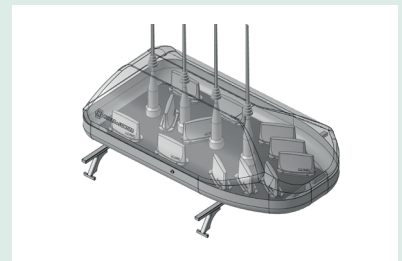

Box builds/mechanical integration

Mechanical integration is a key part of applications that have limited space and that are built into customer-specific sub-systems. HUBER+SUHNER's box build offers additional value by streamlining the integration process, while ensuring superior quality and performance.



End-to-end connectivity solutions

Command and control centers require a host of military-grade RF components. HUBER+SUHNER's defense portfolio covers all of the products required for an end-to-end connectivity solution. These include connectors, EMPs, antennas, cable assemblies as well as a host of interface panes, racks and junction boxes.



RF cable selection guide (US)

Cable type	Outer diameter (inch)	Frequency range (GHz)	VOP (%)	Typ. insertion loss (dB/ft)						CW power (W)		Min. temperature (°C)	Max. temperature (°C)	Min. bending radius (static) (inch)	Weight (lbs/ft)	Dynamic applications	Qualified acc. MIL	Halogen free	Armoring	38999 suitable cable	Cable assembly only
				@ 3 GHz	@ 6 GHz	@ 18 GHz	@ 40 GHz	@ 50 GHz	@ 60 GHz	@ 1 GHz sea level / 25 °C	@ 18 GHz sea level / 25 °C										
SUCOFLEX 101	0.14	50	77	0.259	0.372	0.668	1.036	1.177			337	79	-55	125	0.43	0.024					
SUCOFLEX 550	0.14	50	77	0.259	0.372	0.668	1.036	1.177			337	79	-55	125	0.43	0.022					
SUCOFLEX 550E	0.14	50	77	0.259	0.372	0.668	1.036	1.177			228	54	-40	85	0.43	0.020					
SUCOFLEX 102	0.16	46	77	0.223	0.320	0.570	0.881				448	112	-55	125	0.47	0.027					
SUCOFLEX 102 I	0.16	46	77	0.223	0.320	0.570	0.881				273	64	-40	85	0.47	0.024		*			
SUCOFLEX 102 D	0.18	46	77	0.223	0.320	0.570	0.881				448	112	-55	125	0.59	0.030					
SUCOFLEX 103	0.18	33	77	0.174	0.247	0.448					700	165	-55	125	0.51	0.036					
SUCOFLEX 103 I	0.19	33	77	0.174	0.247	0.448					410	97	-40	85	0.51	0.036		*			
SUCOFLEX 103 D	0.20	33	77	0.174	0.247	0.448					700	165	-55	125	0.79	0.042					
SUCOFLEX 104	0.22	26.5	77	0.140	0.204	0.369					1032	243	-55	125	0.63	0.048					
SUCOFLEX 104 I	0.26	26.5	77	0.140	0.204	0.369					683	161	-40	85	0.63	0.055		*			
SUCOFLEX 104 D	0.24	26.5	77	0.140	0.204	0.369					1032	243	-55	125	0.79	0.050					
SUCOFLEX 126	0.22	26.5	77	0.140	0.204	0.369					1032	243	-55	125	0.63	0.047					
SUCOFLEX 126E	0.22	26.5	77	0.140	0.204	0.369					683	161	-40	85	0.63	0.044					
SUCOFLEX 106	0.31	18	77	0.094	0.140	0.259					1812	427	-55	125	0.94	0.098					
SUCOFLEX 106 I	0.32	18	77	0.094	0.140	0.259					793	187	-40	85	0.94	0.098		*			
SUCOFLEX 106 D	0.33	18	77	0.094	0.140	0.259					1812	427	-55	125	0.94	0.105					
SUCOFLEX 118	0.31	18	77	0.094	0.140	0.259					1812	427	-55	125	0.94	0.098					
SUCOFLEX 229	0.20	29	82	0.134	0.192	0.344					1206	284	-55	165	0.90	0.041					
SUCOFLEX 240	0.16	40	82	0.201	0.287	0.509	0.780				682	161	-55	165	0.33	0.021					
SUCOFLEX 301	0.14	18	77	0.259	0.372	0.668					131	31	-55	125	0.59	0.106					
SUCOFLEX 302 D	0.17	40	77	0.253	0.363	0.646	1.003				448	106	-55	125	0.59	0.022					
SUCOFLEX 304 D	0.23	18	77	0.158	0.226	0.405					1032	244	-55	125	1.18	0.038					
SUCOFLEX 307	0.35	8.0	77	0.085	0.122						1821	-	-55	150	2.95	0.098					
SUCOFLEX 329	0.20	29	82	0.134	0.192	0.344					1206	284	-65	150	0.91	0.028					
SUCOFLEX 340	0.16	40	82	0.201	0.287	0.509	0.780				682	161	-65	150	0.33	0.019					
SUCOFLEX 404	0.22	26.5	89	0.119	0.171	0.311					967	228	-55	125	0.98	0.048					
SUCOFLEX 404 D	0.24	26.5	89	0.119	0.171	0.311					967	228	-55	125	1.18	0.055					
SUCOFLEX 406	0.33	18	89	0.076	0.110	0.204					1890	445	-55	125	1.18	0.097					
SUCOFLEX 406 D	0.34	18	89	0.076	0.110	0.204					1890	445	-55	125	1.57	0.104					
SUCOFLEX 550	0.14	50	77	0.259	0.372	0.668	1.036	1.177			337	79	-55	125	0.43	0.022					
SUCOFLEX 550 E	0.14	50	77	0.259	0.372	0.668	1.036	1.177			228	54	-40	85	0.43	0.020					
Eacon 2C	0.15	18	77	0.223	0.320	0.570					395	93	-55	200	0.47	0.026					
Eacon 4C	0.21	18	77	0.140	0.204	0.369					1032	244	-55	200	0.59	0.048					
Eacon 6C	0.32	18	77	0.094	0.140	0.259					1582	373	-55	200	0.94	0.096					
Microbend	0.08	90	70.3	0.669	0.958	1.717	2.648	2.999	3.625	111	26	-55	200	0.06	0.008						
Microbend L	0.08	85	76	0.493	0.700	1.227	1.859	2.087	2.298	-	-	-55	200	0.20	0.010						
Minibend	0.10	65	70.3	0.442	0.640	1.159	1.822	2.047	2.308	173	41	-55	200	0.20	0.010						
Minibend L	0.11	50	76	0.367	0.520	0.918	1.394	1.567		288	68	-55	200	0.20	0.011						
Mini 141	0.14	40	76.3	0.213	0.305	0.549	0.823			590	139	-55	200	0.33	0.021						
Enviroflex 32084	0.08	40	76	0.598	0.782	1.428	2.108			192	45	-55	200	**	0.007						
Multiflex 53	0.07	67	71	0.637	0.917	1.670	2.630	3.165	3.528	34	8	-65	165	**	0.013						
Multiflex 86	0.10	40	71	0.427	0.619	1.143	1.823			159	38	-65	165	0.25	0.014						
Multiflex 141	0.16	33	71	0.247	0.363	0.701				424	100	-65	165	0.39	0.030						
Sucoform 86	0.08	40	71	0.405	0.597	1.137	1.871			184	43	-65	165	0.24	0.010						
Sucoform 141	0.14	33	71	0.247	0.372	0.747				484	114	-65	165	0.31	0.025						
Semi-rigid 47	0.05	67	69.5	0.658	0.948	1.744	2.778	3.179	3.549	36	9	-40	100	0.13	0.005						
Semi-rigid 86	0.09	67	69.5	0.384	0.568	1.084	1.795	2.080	2.349	148	35	-40	125	0.13	0.015						
Semi-rigid 118	0.12	40	80	0.231	0.333	0.598	0.924			680	160	-40	125	0.38	0.021						
Semi-rigid 141	0.14	33	69.5	0.250	0.381	0.768				512	121	-40	125	0.25	0.035						
Semi-rigid 250	0.25	18	69.5	0.162	0.253	0.549				1593	376	-40	90	0.37	0.106						
Enviroflex_178	0.07	3	71	1.033						67	-	-40	105	0.2	0.004						
Enviroflex_178_D	0.10	6	70	1.033	1.582					67	-	-40	105	0.2	0.008						
Enviroflex_316	0.10	3	71	0.622						100	-	-40	105	0.2	0.011						
Enviroflex_316_D	0.12	6	70	0.585	0.930					122	-	-40	105	0.2	0.014						
Enviroflex_400	0.20	6	70	0.369	0.564					250	-	-40	105	0.39	0.040						
Enviroflex_142	0.20	6	71	0.360	0.570					250	-	-40	105	0.98	0.040						
Enviroflex_393	0.40	6	71	0.213	0.372					550	-	-40	105	1.18	0.121						
Spuma_240-HT	0.20	6	76	0.156	0.340					410	-	-55	150	0.99	0.040						
Spuma_400-HT	0.37	6	76	0.088	0.122					1000	-	-55	150	1.75	0.101						
Spuma_600-HT	0.56	6	76	0.058	0.085					2111	-	-55	150	2.75	0.210						
Spuma_195/ -FR	0.19	6	80	0.232	0.335					178	-	-40	85	0.49	0.020						
Spuma_240/ -FR	0.24	6	84	0.155	0.229					288	-	-40	85	0.75	0.034						
Spuma_400 / -FR	0.40	6	85	0.079	0.118					667	-	-40	85	0.98	0.063						
Spuma_500 / -FR	0.50	6	86	0.064	0.096					833	-	-40	85	1.34	0.120						
Spuma_600	0.59	6	85	0.055	0.079					1033	-	-40	85	1.5	0.134						

* LSFH only on jacket/dielectric contains fluor (PTFE)

** please ask our local sales rep for additional information

RF cable selection guide (metric)

Cable type	Outer diameter (mm)	Frequency range (GHz)	VOP (%)	Typ. insertion loss (dB/m)						CW power (W)		Min. temperature (°C)	Max. temperature (°C)	Min. bending radius (static) (mm)	Weight (g/m)	Dynamic applications	Qualified acc. MIL	Halogen free	Armoring	38999 suitable cable	Cable assembly only
				@ 3 GHz	@ 6 GHz	@ 18 GHz	@ 40 GHz	@ 50 GHz	@ 60 GHz	@ 1 GHz sea level / 25 °C	@ 18 GHz sea level / 25 °C										
				SUCOFLEX 101	3.7	50	77	0.77	1.10	1.99	3.09										
SUCOFLEX 550	3.7	50	77	0.77	1.1	1.99	3.09	3.51		337	79	-55	125	11	33						
SUCOFLEX 550E	3.7	50	77	0.77	1.1	1.99	3.09	3.51		228	54	-40	85	11	30						
SUCOFLEX 102	4.0	46	77	0.66	0.95	1.70	2.62			448	112	-55	125	12	40						
SUCOFLEX 102 I	4.0	46	77	0.66	0.95	1.70	2.62			273	64	-40	85	12	36		*				
SUCOFLEX 102 D	4.6	46	77	0.66	0.95	1.70	2.62			448	112	-55	125	15	45						
SUCOFLEX 103	4.6	33	77	0.51	0.74	1.33				700	165	-55	125	13	53						
SUCOFLEX 103 I	4.8	33	77	0.51	0.74	1.33				410	97	-40	85	13	53		*				
SUCOFLEX 103 D	5.1	33	77	0.51	0.74	1.33				700	165	-55	125	20	63						
SUCOFLEX 104	5.5	26.5	77	0.42	0.60	1.10				1032	243	-55	125	16	73						
SUCOFLEX 104 I	6.6	26.5	77	0.42	0.60	1.10				683	161	-40	85	16	82		*				
SUCOFLEX 104 D	6.1	26.5	77	0.42	0.60	1.10				1032	243	-55	125	20	96						
SUCOFLEX 126	5.5	26.5	77	0.42	0.60	1.10				1032	243	-55	125	16	70						
SUCOFLEX 126E	5.5	26.5	77	0.42	0.60	1.10				683	161	-40	85	16	66						
SUCOFLEX 106	7.9	18	77	0.28	0.41	0.76				1812	427	-55	125	24	145						
SUCOFLEX 106 I	8.2	18	77	0.28	0.41	0.76				793	187	-40	85	24	146		*				
SUCOFLEX 106 D	8.3	18	77	0.28	0.41	0.76				1812	427	-55	125	26	157						
SUCOFLEX 118	7.9	18	77	0.28	0.41	0.76				1812	427	-55	125	24	145						
SUCOFLEX 229	5.1	29	82	0.41	0.59	1.06				1206	284	-55	165	23	61						
SUCOFLEX 240	4.1	40	82	0.63	0.90	1.61	2.47			682	161	-55	165	8.4	31						
SUCOFLEX 301	3.5	18	77	0.77	1.10	1.99				131	31	-55	125	15	23.9						
SUCOFLEX 302 D	4.3	40	77	0.66	0.95	1.70	2.62			448	106	-55	125	15	31						
SUCOFLEX 304 D	6.0	18	77	0.42	0.60	1.10				1032	244	-55	125	20	56						
SUCOFLEX 307	9.0	8.0	77	0.25	0.36	-				1821	-	-55	150	50	133						
SUCOFLEX 329	5.1	29	82	0.41	0.59	1.06				1206	284	-65	150	23	40						
SUCOFLEX 340	4.2	40	82	0.63	0.90	1.61	2.47			682	161	-65	150	8.4	27						
SUCOFLEX 404	5.5	26.5	89	0.38	0.54	0.99				967	228	-55	125	25	72						
SUCOFLEX 404 D	6.1	26.5	89	0.38	0.54	0.99				967	228	-55	125	30	82						
SUCOFLEX 406	8.3	18	89	0.23	0.33	0.61				1890	445	-55	125	30	145						
SUCOFLEX 406 D	8.8	18	89	0.23	0.33	0.61				1890	445	-55	125	40	155						
SUCOFLEX 550	0.77	50	77	0.77	1.10	1.99	3.09	3.51		337	79	-55	125	11	33						
SUCOFLEX 550 E	0.77	50	77	0.77	1.10	1.99	3.09	3.51		228	54	-40	85	11	30						
Eacon 2C	3.8	18	77	0.66	0.95	1.70				395	93	-55	200	12	39						
Eacon 4C	5.5	18	77	0.42	0.60	1.10				1032	244	-55	200	16	73						
Eacon 6C	7.7	18	77	0.28	0.41	0.76				1582	373	-55	200	24	148						
Microbend	2.0	90	70.3	1.97	2.82	5.05	7.79	8.82	9.78	111	26	-55	200	1.50	11.9						
Microbend L	2.0	85	76	1.45	2.06	3.61	5.47	6.14	6.76	-	-	-55	200	-	-						
Minibend	2.5	65	70.3	1.30	1.88	3.41	5.36	6.10	6.79	173	41	-55	200	5.08	14.9						
Minibend L	2.7	50	76	1.08	1.53	2.70	4.10	4.61		288	68	-55	200	6.4	16.4						
Mini 141	3.7	40	76.3	0.67	0.95	1.70	2.61			590	139	-55	200	8.4	31.3						
Everflex 32084	2.4	40	76	1.76	2.30	4.20	6.20			192	45	-55	200	**	10.4						
Multiflex 53	1.74	67	71	1.98	2.86	5.20	8.17	9.31	10.37	34	8	-65	165	**	8.5						
Multiflex 86	2.7	40	71	1.32	1.92	3.55	5.67			159	38	-65	165	6	21						
Multiflex 141	4.2	33	71	0.73	1.08	2.09				424	100	-65	165	10	45						
Sucoform 86	2.1	40	71	1.21	1.78	3.39	5.57			184	43	-65	165	6	15						
Sucoform 141	3.6	33	71	0.73	1.11	2.23				484	114	-65	165	8	38						
Semi-rigid 47	1.2	67	69.5	1.92	2.79	5.13	8.17	9.35	10.44	36	9	-40	100	3.18	7.1						
Semi-rigid 86	2.2	67	69.5	1.13	1.67	3.19	5.28	6.12	6.91	148	35	-40	125	3.18	24						
Semi-rigid 118	3.0	40	80	0.68	0.98	1.76	2.72			680	160	-40	125	9.53	34						
Semi-rigid 141	3.6	33	69.5	0.68	1.04	2.09				512	121	-40	125	6.35	52						
Semi-rigid 250	6.4	18	69.5	0.44	0.69	1.50				1593	376	-40	90	19	158						
Enviroflex_178	1.84	3	71	3.11	-					67	-	-40	105	5	6.5						
Enviroflex_178_D	2.45	6	70	3.08	4.72					67	-	-40	105	5	11.2						
Enviroflex_316	2.54	3	71	1.86	-					100	-	-40	105	5	16						
Enviroflex_316_D	3.16	6	70	1.52	2.27					122	-	-40	105	5	21						
Enviroflex_400	5.00	6	70	1.12	1.84					250	-	-40	105	10	60						
Enviroflex_142	5.00	6	71	1.06	1.75					250	-	-40	105	30	60						
Enviroflex_393	10.05	6	71	0.64	1.11					550	-	-40	105	30	180						
Spuma_240-HT	5.21	6	76	0.46	0.66					410	-	-55	150	25.4	60						
Spuma_400-HT	9.40	6	76	0.26	0.36					1000	-	-55	150	44.5	150						
Spuma_600-HT	14.38	6	76	0.17	0.25					2111	-	-55	150	70	310						
Spuma_195/ -FR	4.95	6	80	0.70	1.02					178	-	-40	85	12.5	30						
Spuma_240/ -FR	6.15	6	84	0.48	0.69					288	-	-40	85	19	50						
Spuma_400 / -FR	10.25	6	85	0.24	0.35					667	-	-40	85	25	94						
Spuma_500 / -FR	12.78	6	86	0.20	0.29					833	-	-40	85	34	178						
Spuma_600	14.99	6	85	0.16	0.24					1033	-	-40	85	38	200						

* LSFH only on jacket/dielectric contains fluor (PTFE)

** please ask our local sales rep for additional information

Aerospace+Defense Microsite

HUBER+SUHNER COMPANY SOLUTIONS PRODUCTS SERVICES CONTACTS SEARCH Q ENGLISH V

DEFENSE APPLICATIONS | PRODUCTS

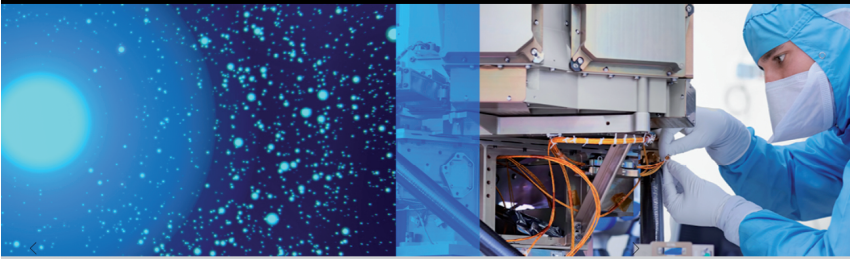

YOUR PARTNER FOR SYSTEM SOLUTIONS

HUBER+SUHNER unites technical and manufacturing expertise in radio frequency, fiber optical and low frequency technologies under one roof and offers a high-quality product range for the defense market.

SOLUTIONS ← DEFENSE

DEFENSE



Mission Critical Networks → RF-over-Fiber solutions → Low loss combined with high flexibility →

aerospacedefense.hubersuhner.com

EMP Calculation Tool

HUBER+SUHNER Excellence in Connectivity Solutions

RF PRODUCT SEARCH REQUEST QUOTATION

RF Assembly Calculator

*optional *optional

Connectors

Connector 1	<input checked="" type="radio"/> None	<input type="radio"/> Straight <input type="text" value="0.025"/> dB	<input type="radio"/> 90° Box <input type="text" value="0.04"/> dB	<input type="radio"/> 90° Swept <input type="text" value="0.03"/> dB
Connector 2	<input checked="" type="radio"/> None	<input type="radio"/> Straight <input type="text" value="0.025"/> dB	<input type="radio"/> 90° Box <input type="text" value="0.04"/> dB	<input type="radio"/> 90° Swept <input type="text" value="0.03"/> dB

Parameters

Frequency GHz Ambient temperature °C

Cable length m Altitude m

CALCULATE

The EMP Protector Tool Box will help you to select the right protector for your specific applications. Furthermore, it allows you to calculate the correct gas capsule size for the GDT series and gives you guidance on the interface power handling capabilities.

rfcablecalc.hubersuhner.com

Product selection guides

1. EVALUATE with our product finder

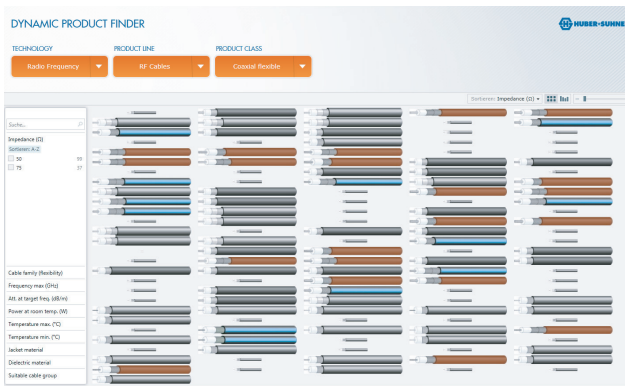

By using our "product finder" please choose the suitable cable, connector, adaptor, EMP or antenna. You will find this utility on our homepage or with following link:

products.hubersuhner.com

2. CONFIGURE with the assembly configurator

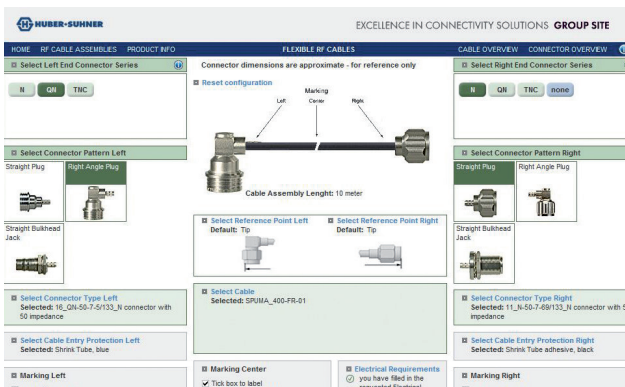

By using the "RF assembly configurator" you can define the suitable assembly. You will find this utility on our homepage or with following link:

rfwebpcf.hubersuhner.com

3. CALCULATE with the assembly calculator

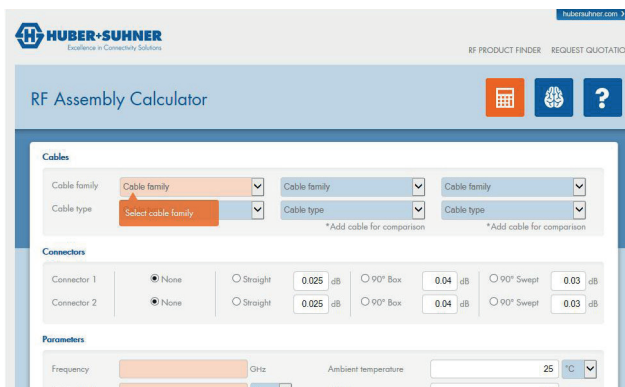

Define the suitable assembly by using the "RF assembly calculator". You will find this utility on our homepage or with following link:

fablecalc.hubersuhner.com

HUBER+SUHNER AG
Degersheimerstrasse 14
9100 Herisau
Switzerland
Phone: +41 71 353 4111
hubersuhner.com

HUBER+SUHNER Astrolab
4 Powder Horn Drive
Warren, New Jersey
07059-5105 USA
Phone +1 732-560-3800
Fax +1 732-560-9570
hubersuhner.com

HUBER+SUHNER is certified according to EN(AS) 9100, ISO 9001, ISO 14001, ISO/TS 16949 and IRIS.

Waiver

Fact and figures herein are for information only and do not represent any warranty of any kind.