

Wireless Infrastructure

Solutions for remote radios and cell sites

Edition 2023/04

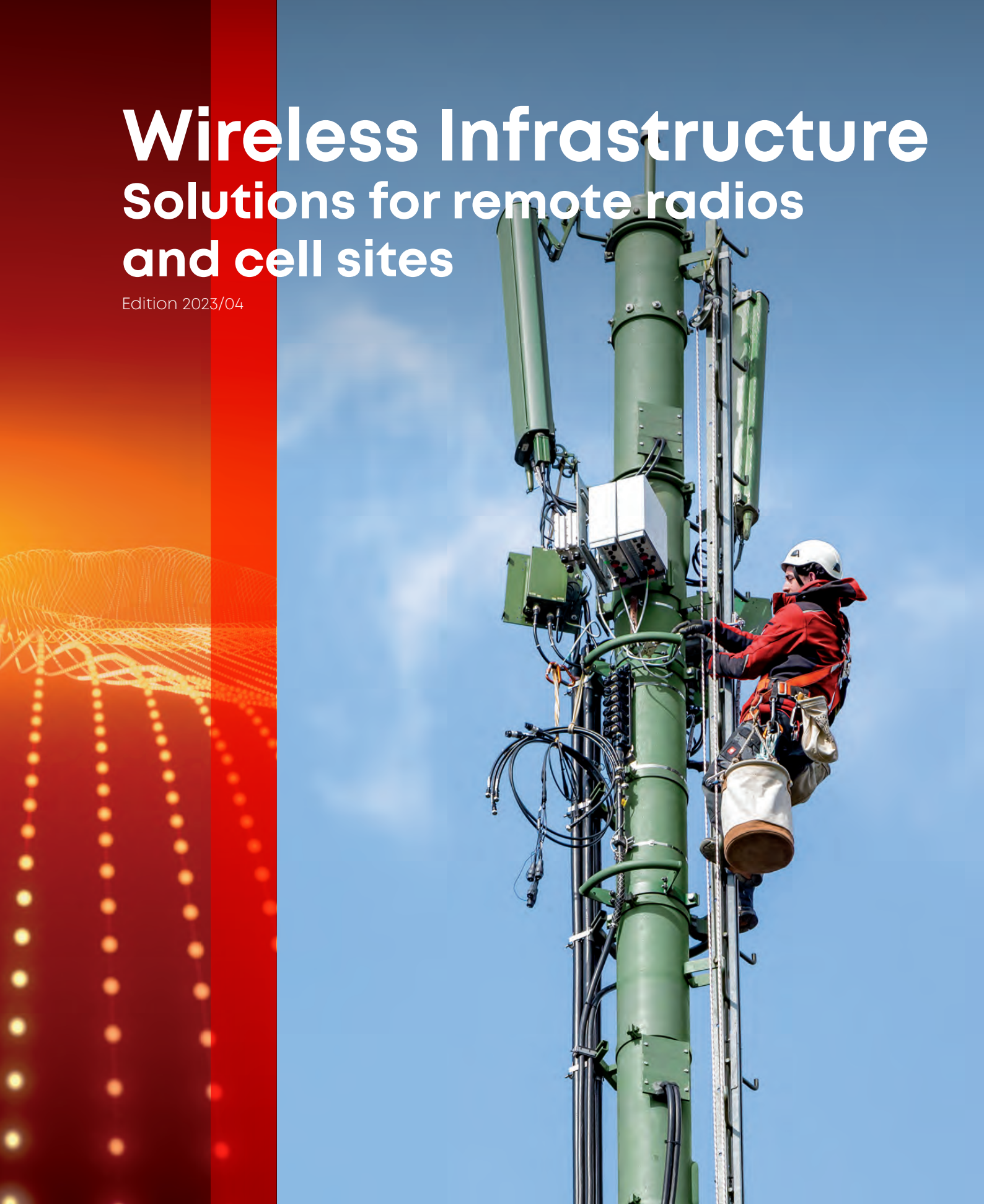

Count on proven wireless technology





About HUBER+SUHNER

The HUBER+SUHNER group is a leading global supplier of components and systems for electrical and optical connectivity. Our customers in communication, industry and transportation appreciate that we are specialists with detailed knowledge of practical applications. We offer expertise in radio frequency, fiber optics and low frequency all under one roof, thus providing a unique basis for continual innovation which is focused on the needs of our customers all over the world.

At the heart of our offering is a broad range of products that can be relied on to meet high quality standards, backed up by flexible, dependable services with fast response times and excellence in delivery performance. In the wireless market, we concentrate on solutions that allow mobile operators to reduce their total cost of ownership and to make their mobile network futureproof and reliable.

Content

Remote radio installation solutions	6
Discrete fiber optic feeders for single RRH	14
Discrete power feeders for single RRH	21
MASTERLINE Ultimate (MLU)	24
MASTERLINE Ultimate Power (MLUP)	38
MASTERLINE Extreme (MLE)	44
MASTERLINE Extreme Power (MLEP)	54
MASTERLINE Classic (MLC)	60
Multicore power supply cable	68
MASTERLINE Ultimate Hybrid (MLUH)	76
MASTERLINE Ultimate Hybrid High Voltage (MLUH HV)	90
MASTERLINE Extreme Hybrid (MLEH)	100
MASTERLINE Classic Hybrid (MLCH)	114
Accessories	124
Fiber optic interfaces for remote radio heads	140
Conventional cell site solutions	158
LISCA – RF jumpers	160
Universal Weather Protection (UWP)	164
SUCOFEEED corrugated cables	166
SUCOFEEED aluminium corrugated cables	175
Flexible RF plenum jumper	178
Copper – corrugated cables	180
Quick-Fit coaxial connectors	182
Cable stripping tools	186
Spuma – flexible, low-loss RF cables	190
Lightning protectors	194
Grounding kits and accessories	208
Power splitters	212
Low PIM T+M grade components	216
RF Feederline components selection guide	222
Cell site connectivity	226
CUBO systems	228
Network cubes	232
Inteegrated network cubes	238
Pluggable transceiver	252
Timing solutions – GPS-over-Fiber	256
HUBER+SÜHNER benefits	260

Remote radio installation solutions



Work with the leader for remote radio installation solutions

HUBER+SUHNER provides complete installation solution

HUBER+SUHNER is the global leader for remote radio installation solutions. We have a comprehensive offering of Fiber-To-The-Antenna (FTTA), Power-To-The-Antenna (PTTA) and Hybrid-To-The-Antenna (HTTA) products, which are tailored to the customer's needs. We advise operators about which installation methods are available and what their advantages are. We are experts on how to make savings on installation costs and how expensive follow-up costs can be saved. HUBER+SUHNER implements future-proof passive cable network infrastructures, which are compatible with all system vendor products and endure the future generations of active equipment.

MASTERLINE fiber optic cabling systems of HUBER+SUHNER

HUBER+SUHNER offers 3 different FTTA cabling systems, MASTERLINE Classic (MLC), MASTERLINE Extreme (MLE) and MASTERLINE Ultimate (MLU). MASTERLINE cabling systems of HUBER+SUHNER are the most efficient and easiest-to-install fiber optic products available on the market. All MASTERLINE fiber optic cabling systems of HUBER+SUHNER use glass-armoured multifiber loose tube cables (6 to 48 fibers). With a short fiber optic jumper the cabling systems are quickly and easily connected to the vendor specific RRH interfaces.

MASTERLINE Ultimate has a compact, pre-connectorised and factory-sealed connector head with 12 Q-ODC-2 sockets. The robust connector head with an integrated pulling eye allows easy cable lifting. The encapsulated connector head can be directly attached to the mast with a single „click“ at a pre-mounted adapter plate. Short easy-to-install Q-ODC fiber optic jumpers connect the RRH interface.

MASTERLINE Extreme has a robust and very compact divider, which divides the fibers in 6 or 12 single cables terminated with Q-ODC-2 extension connectors. The very compact divider requires only a small space on the mast, minimises the wind-load and can be fed through small holes. Short easy-to-install Q-ODC fiber optic jumpers connect the RRH interface.

MASTERLINE Classic has a divider, which divides the fibers in 6, 12, 18 or 24 single cables terminated with LC duplex connectors. The divider is fixed at a distribution box and the LC duplex connectors connected to adapters. Short LC duplex jumper connect the RRH interfaces.



MASTERLINE Ultimate



MASTERLINE Extreme



MASTERLINE Classic

Work with the leader for remote radio installation solutions

MASTERLINE hybrid cabling systems of HUBER+SUHNER

Hybrid cables, combining optical fiber and DC power for remote radios, have evolved as the dominating solution in North America, Australia and Europe. MASTERLINE hybrid cabling systems of HUBER+SUHNER are the most efficient and easiest-to-install products available on the market. Mobile operators on four continents verified that MASTERLINE Hybrid can be installed in approximately half of the time of competitive hybrid solutions based on corrugated coax cable designs. The factory-terminated „plug & play“ system in combination with a highly flexible and easy-to-route cable makes the HUBER+SUHNER solution the hybrid cable of choice for operators, system vendors and installers alike.

HUBER+SUHNER offers 3 different hybrid cabling systems, MASTERLINE Classic Hybrid (MLCH), MASTERLINE Extreme Hybrid (MLEH) and MASTERLINE Ultimate Hybrid (MLUH). All HUBER+SUHNER's MASTERLINE Hybrid cabling systems use highly flexible hybrid cables with a multifiber loose tube cables (6 to 36 fibers) and up to 18 copper conductors. With a short fiber optic jumper the cabling systems are quickly and easily connected to the vendor specific RRH interfaces.

MASTERLINE Ultimate Hybrid has a compact, pre-connectorised and factory-sealed connector head with up to 6 Q-ODC-2 sockets and up to 6 power sockets. The robust connector head with an integrated pulling eye allows easy cable lifting. The encapsulated connector head can be directly attached to the mast with a single „click“ at a pre-mounted adapter plate. Short easy-to-install Q-ODC fiber optic and power jumpers connect the RRH interface.

The most innovative hybrid cabling system of HUBER+SUHNER for remote radio installation became even more innovative by offering capability to deliver 230 VAC up the mast, allowing much longer cabling with significant cost savings on cables and more efficient power transfer. The pre-connectorised factory-sealed hybrid systems supports up to 12 RRHs and connects the remote radios with easy-to-install Q-ODC fiber optic and power jumpers. The encapsulated connector head can be directly attached to the mast with a single „click“ at a pre-mounted adaptor plate. These unique features make MASTERLINE Ultimate Hybrid High Voltage the only in-class product offering all the advantages of the MASTERLINE Ultimate family together with high voltage conformity confirmed by the worldwide recognised CE marking. For extra safety the whole head is protected by removable cover.

MASTERLINE Extreme Hybrid has a robust and very compact divider, which divides the fibers in up to 18 single cables terminated with Q-ODC-2 extension connectors and up to 9 power cables. The very compact divider requires only a small space on the mast, minimises the wind-load and can be fed through small holes (80/100 mm diameter). Short easy-to-install Q-ODC fiber optic and power jumpers connect the RRH interface.

MASTERLINE Classic Hybrid has a divider, which divides the fibers in 6, 12, 18 or 24 single cables terminated with LC duplex connectors. The hybrid cable is fed into a distribution box. The LC duplex connectors are connected to adapters and the conductors terminated to screw terminals. Short LC duplex and power jumper connect the RRH interfaces.

Work with the leader for remote radio installation solutions

MASTERLINE cabling systems of HUBER+SUHNER: reduced installation cost, flexibility and scalability

Reduced installation costs

MASTERLINE cabling systems are more cost-effective, because only 1 cable is laid instead of 6 or more. As the number of RRHs rises, cost efficiency rises accordingly. The length of time required for installation is a major cost factor. Cabling systems of HUBER+SUHNER are pre-connectorised „plug & play“ solutions and can be connected directly with the active equipment. In addition, the multi-riser cables are more rigid than individual cables due to their increased diameter, meaning that the securing clips can be installed at intervals of between 1.5 and 2 meters. Empirical data indicates that cable installation times can be reduced by between a third and a half (compared to discrete cables). With our latest hybrid cabling system MASTERLINE Ultimate Hybrid High Voltage the installation cost can be reduced further. The capability to deliver 230 VAC up the mast, allows significant cost savings on cables due to more efficient power transfer.

Flexibility

Only the short jumper cables may need to be renewed when upgrading or replacing the RRH. Most of the installed passive infrastructure remains unaffected. This means that the installation is independent of the system and manufacturer and offers maximum flexibility in terms of evolution within the network.

Scalability

Additional RRHs must be installed when setting up new systems or frequency bands. During initial installation, 12 or 24 integrated fiber optic cores can be laid instead of 6, so that the necessary fibers are already in place if new services are being set up at a later date. No expensive new cable installations are required – all that is needed is a number of additional jumpers.



MASTERLINE Extreme Hybrid



MASTERLINE Ultimate Hybrid

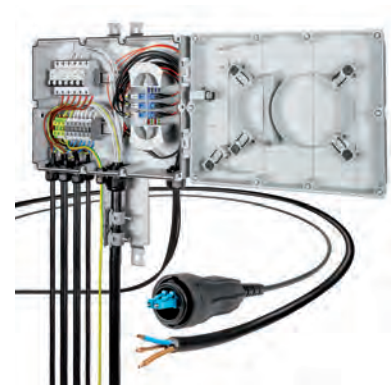

MASTERLINE Classic Hybrid

Work with the leader for remote radio installation solutions

Total cost of ownership analysis

HUBER+SUHNER offers total cost of ownership (TCO) analysis for network upgrades and expansions. In close co-operation with mobile operators we have developed a sound understanding of real costs and roll out issues associated with remote radio systems. The optimum installation solution depends very much on the legacy infrastructure, on the installation phase, on the material supply chain and on future expansion plans. HUBER+SUHNER has consulted with network deployment managers across the globe on how to save millions on installation and material costs by deploying reliable cable infrastructures which are easy and cost effective to install and which fulfill today's and tomorrow's network deployment requirements.

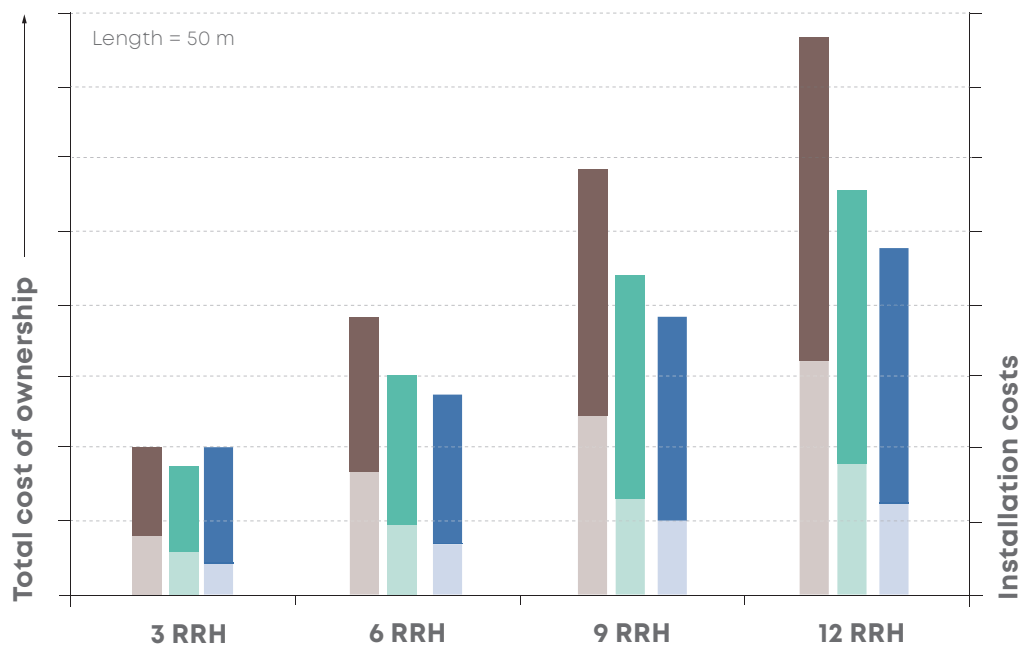

Example: 50 m remote radio head installation in UK

TCO calculation model of HUBER+SUHNER provides a country/operator specific TCO comparison between the different installation solutions.

Please contact your sales representative for an individualised TCO calculation.

Discrete cable

- Material costs
- Installation costs

Hybrid

- Material costs
- Installation costs

Multiriser

- Material costs
- Installation costs

Work with the leader for remote radio installation solutions

Power design tool for remote radios – Powering 5G networks

Mobile networks are drawing a lot of power. 5G networks will require even more power to bring the benefits it promises. This results in an near duplication of the power requirement per active equipment. The power design tool supports system engineers to correctly dimension DC power cables or to verify the limits of an existing power supply system. It is a powerful and easy-to-use tool to answer the following questions:

- What is the maximum allowable RRH power consumption at given cable configuration?
- What is the minimum required cable cross section to supply a specific RRH at a given tower height?
- What is the maximum allowed cable length of a pre-specified cable cross section and RRH? E. g., a 1000 W remote radio with 10 mm² power cable.

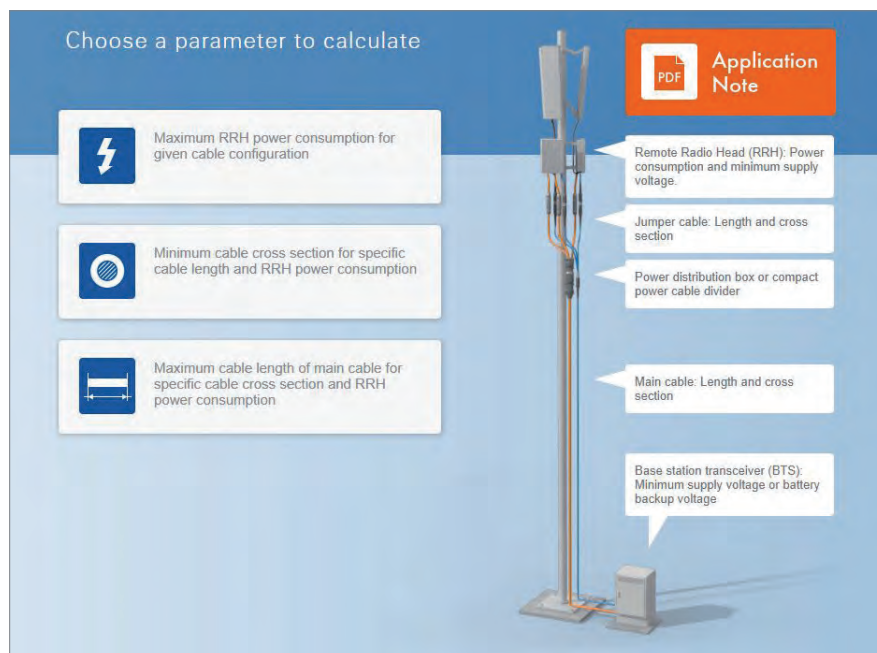

Make your own power dimensioning under

<https://pdt.hubersuhner.com/>

Quick guide on installation solutions

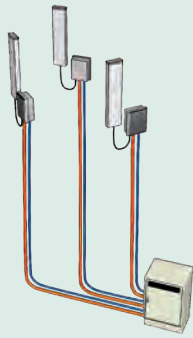

Discrete fiber feeders for single RRH

- One fiber optic feeder per RRH needed
- Default solution of system vendors
- Not scalable and not future-proof
- Vendor specific cables and connectors

Discrete power feeders for single RRH

- One power feeder cable per RRH needed

→ page 14

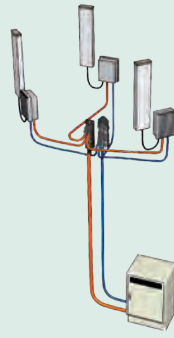

MASTERLINE Ultimate (MLU)

- Multi-riser cable with compact connector head up to 12 RRHs
- Pre-connectorised fiber optic cabling system with up to 12 outdoor socket connectors (Q-ODC)
- Installation friendly plug & play system with outdoor connectors
- Low wind-load and space efficient
- Supports multi-vendor installs

MASTERLINE Ultimate Power (MLUP)

- Multi-wire power cable with compact power connector head for up to 6 RRHs
- Pre-connectorised power cabling system with up to 6 power socket connectors (IP68)

→ page 24

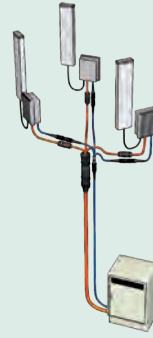

MASTERLINE Extreme (MLE)

- Multi-riser cable with compact divider for up to 12 RRHs
- Pre-assembled fiber optic cabling system with up to 12 outdoor connectors (Q-ODC)
- Installation friendly plug & play system with outdoor connectors
- Low wind-load and space efficient
- Supports multi-vendor installs

MASTERLINE Extreme Power (MLEP)

- Multi-wire power cable with compact divider for up to 6 RRHs
- Pre-assembled power cabling system with up to 6 power socket connectors (IP68) or open-end wires

→ page 44

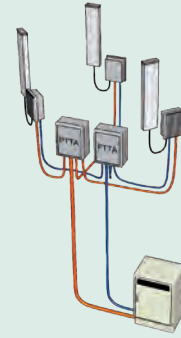

MASTERLINE Classic (MLC)

- Multi-riser cable with distribution box for up to 24 RRHs
- Pre-assembled fiber optic cabling system with up to 12 indoor connectors (LC duplex)
- Requires handling of indoor fiber optic connectors
- Supports multi-vendor installs

Multicore Power supply cable with distribution box

- 2, 6 or 12 wire shielded power supply cable with distribution box for up to 6 RRHs
- Power distribution box with optional surge protection device and/or circuit breaker

→ page 60

Quick guide on installation solutions

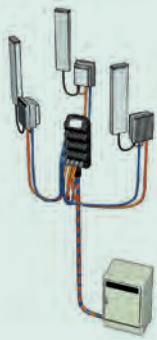

MASTERLINE Ultimate Hybrid High Voltage (MLUH HV)

- Hybrid riser cable with compact connector head high voltage (230 VAC) CE conformity
- Suitable for 230 VAC power supply
- Allowing much longer cabling length
- Significant cost savings on cables
- More efficient power transfer
- Pre-connectorised factory-sealed hybrid cable system for 12 RRH
- Mounting bracket for easy mast-, pole-, and wall-installation
- Integral earth point
- Equipped with protection cover for cable exits

→ page 74

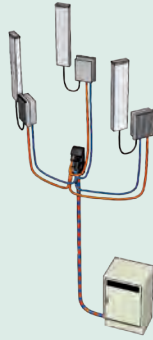

MASTERLINE Ultimate Hybrid (MLUH)

- Hybrid riser cable with compact connector head for up to 6 RRHs
- Pre-connectorised hybrid cabling system with up to 6 fiber optic outdoor socket connectors (Q-ODC) and up to 6 power socket connectors (IP68)
- Optional with Q-ODC-12 connector for up to 18 fiber optic interfaces
- Ultimate „plug & play” solution
- Fast and safe installation
- Low wind-load and space efficient
- Supports multi-vendor installs
- Hybrid cable combines glass fiber cables and copper conductors within a single cable

→ page 84



MASTERLINE Extreme Hybrid (MLEH)

- Hybrid riser cable with compact divider for up to 9 RRHs
- Pre-assembled hybrid cabling system with up to 18 fiber optic outdoor connectors (Q-ODC) and up to 9 power socket connectors (IP68)
- Most commonly installed hybrid product globally
- Fast and safe installation
- Low wind-load and space efficient
- Supports multi-vendor installs
- Hybrid cable combines glass fiber cables and copper conductors within a single cable

→ page 98

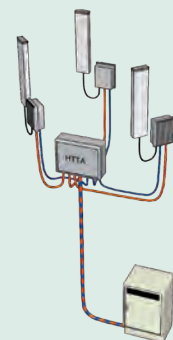

MASTERLINE Classic Hybrid (MLCH)

- Hybrid riser cable with distribution box for up to 6 RRHs
- Pre-assembled hybrid cabling system with up to 12 fiber optic indoor connectors (LC duplex) and up to 6 pairs of copper wires
- Hybrid distribution box with optional surge protection device and/or circuit breaker
- High wind-load compared with MLUH and MLEH
- Elaborate box installation at mast required
- Supports multi-vendor installs
- Hybrid cable combines glass fiber cables and copper conductors within a single cable

→ page 114

Discrete fiber optic feeders for single RRH



The solution with discrete fiber and power cables supports every type of cell site installation, whether the remote radios are co-located (mast-top installation) or distributed on rooftops of buildings.

HUBER+SUHNER has a leading role in the design and manufacturing of harsh environment connectors (e.g. ODC, FullAXS, Q-ODC or Q-XCO) and cable assemblies for remote radio systems. The installation method with discrete cables is the default solution of mobile system vendors.

HUBER+SUHNER is an approved and qualified cable assembly supplier for the majority of the tier 1 and tier 2 system vendors.

Discrete fiber optic feeders for single RRH

RF LISCA RF jumper
page 162



PTTA Power distribution box with surge protection (optional)
page 69



FTTA Discrete fiber optic feeder for single RRH
page 14



PTTA Discrete power feeder for single RRH
page 21



XTTA Cable clamps
page 134



FTTA Overlength box
page 127

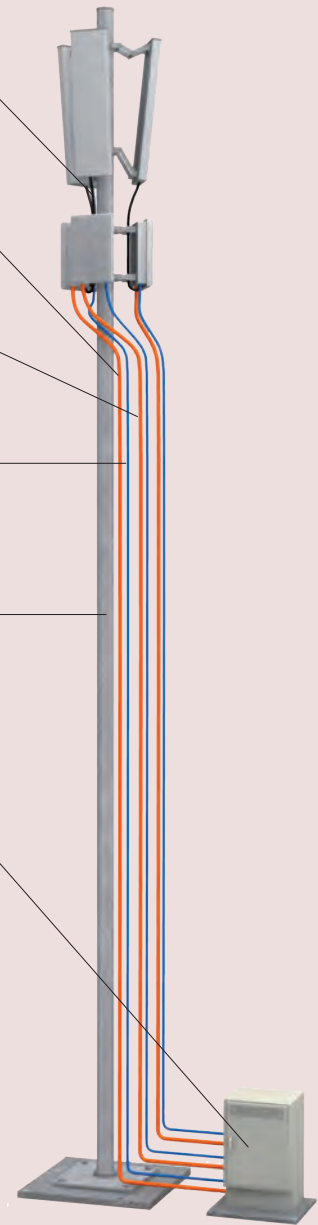

XTTA FTTA, PTTA and HTTA

PTTA Power-To-The-Antenna

RF Radio Frequency

HTTA Hybrid-To-The-Antenna

FTTA Fiber-To-The-Antenna

Discrete fiber feeders for single RRH



Features

- FTTA feeders for all common RRH models and systems
- Ruggedised design and installation proof
- Standard assemblies and customised lengths, available with short lead-time
- Cable diameter 4.8 mm, 5.5 mm
- All cables rodent resistant, CPR compliant and UL (OFNR) approved
- All cable assemblies factory-terminated and tested
- Anatel approved cables, available on request

Specifications

Outer cable diameter	4.8 mm	5.5 mm
Jacket material	LSFH™	
Cable tensile strength (service/during installation)	500/1000 N	
Cable crush resistance (long-term/short-term)	6000/20 000 N/dm	
Temperature range	-40 to +75 °C	
Flame resistance	IEC 60332-1, IEC 60332-3-24, UL1666	
UV resistant	yes	

HUBER+SUHNER cables are deployed on a global scale

Year by year, HUBER+SUHNER produces tens of thousands of FTTA feeder cables and is a leading global supplier to major system vendors and operators. Our customers value our quality products which are manufactured on all continents close to the local markets.

HUBER+SUHNER is also an innovation leader for remote radio interfaces and is the owner of globally successful products like ODC, Q-ODC and Q-XCO.



Discrete fiber feeders for single RRH

Ordering information

FullIAXS feeder with 4.8 mm cable



Length	Item no. single-mode E9/125 A2 (G.657.A2)
	CPR D _{ca} and UL listed OFNR
15 m	85101684
20 m	85101685
30 m	85101686
40 m	85101687
50 m	85101688
60 m	85101689
70 m	85101690
80 m	85101691
90 m	85101692
100 m	85101693
125 m	85101694
150 m	85101695

LC feeder with moulded divider and ruggedised break-out 98 mm long, Ø 4.8 mm cable



Length	Item no. single-mode E9/125 A2 (G.657.A2)
	CPR D _{ca} and UL listed OFNR
10 m	85031795
20 m	85031796
30 m	85031797
40 m	85031798
50 m	85031799
60 m	85031800
70 m	85031801
80 m	85031802
90 m	85031803
100 m	85031804
125 m	85031805
150 m	85031806

Discrete fiber feeders for single RRH

LC feeder with metal divider and ruggedised break-out 90 mm long Ø 4.8 mm cable



Length	Item no. single-mode E9/125 A2 (G.657.A2)	
	CPR D _{ca} and UL listed OFNR	
10 m	85101708	
20 m	85101709	
30 m	85101710	
40 m	85101711	
50 m	85101712	
60 m	85101713	
70 m	85101714	
80 m	85101715	
90 m	85101716	
100 m	85101717	
125 m	85101718	
150 m	85101719	

LC feeder with ruggedised break-out 85 mm long Ø 5.5 mm cable



Length	Item no. single-mode E9/125 A1 (G.657.A2)		Item no. multimode G50/125 OM3	
	UL listed OFNR	CPR D _{ca}	UL listed OFNR	CPR D _{ca}
10 m	84136460	85101720	84136459	85101731
15 m	84104111	85101721	84104137	85101732
30 m	84104112	85101722	84104138	85101733
50 m	84104113	85101723	84104139	85101734
70 m	84104114	85101724	84104140	85101735
85 m	84104115	85101725	84104142	85101736
100 m	84104116	85101726	84104143	85101737
150 m	84104117	85101727	84104144	85101738

Discrete fiber feeders for single RRH

LC feeder with ruggedised break-out 90 mm long, Ø 4.8 mm cable (Ø 7.0 mm at the RRH pre-chamber entry position)







Length	Item no. single-mode E9/125 A2 (G.657.A2)	Item no. multimode G50/125 OM3
	CPR D _{ca} and UL listed OFNR	CPR D _{ca} and UL listed OFNR
10 m	85101742	85101756
15 m	85101743	85101757
20 m	85101744	85101758
30 m	85101745	85101759
40 m	85101746	85101760
50 m	85101747	85101761
60 m	85101748	85101762
70 m	85101749	85101763
80 m	85101750	85101764
90 m	85101751	85101765
100 m	85101752	85101766
125 m	85101753	85101767
150 m	85101754	85101768

Please contact HUBER+SUHNER for other OEM interfaces which are not listed on page 17 to 19.



Discrete fiber feeders for single RRH

Region specific cable assemblies

Ask for approved regional item numbers fulfilling local market requirements.

US/North America	UL approved cables	
Europe	CPR approved cables	
Brazil	Anatel approved cables	
India	Monkey-bite proof cables	

Accessories

Description	Item no.	Page	
For outdoor and indoor installation, stores up to 20 m cable excess length (depending on cable diameter)	84103325	127	
Combined clamps for fiber optic and power cable	depends on cable diameter	134	
SFP/SFP+ transceivers for different protocols, data rates and power budgets	See transceiver selection guide on page 260	259	

Discrete power feeders for single RRH

2 core power cable with aluminium foil shielding, red and white insulation and CPR class B2_{ca}



Features

- highly flexible power cable with low bending radius and excellent cable routing properties
- Red and white XLPE insulation compliant to IEC60445:2021
- Aluminum foil shielding with tinned copper drain conductor
- CPR compliant class B2_{ca}
- Voltage rating 600 V

Specifications

Jacket material	LSFH
Insulation material	XLPE
Insulation color IEC 60445:2021	red, white
Screen	Aluminum/PET foil with tinned copper drain conductor
Drain wire type IEC 60228	Annealed tinned copper class 5
UV-resistant	According to IEC 60068-2-5
CPR classification	B2 _{ca} -s1,d2,a1
Standard	IEC 60502 / IEC 60092
Rated voltage	0.6/1.0 kV
Temperature range	-40 to 85°C
Conductor type IEC 60228	Annealed copper class 5

Conductor cross section	6 mm ²	10 mm ²	16 mm ²	25 mm ²
Conductor resistance	3.30 Ω/km	1.91 Ω/km	1.21 Ω/km	0.78 Ω/km
Maximum current rating at 60 °C ambient temperature	45 A	61 A	82 A	105 A
Drain wire cross section	4 mm ²	6 mm ²	6 mm ²	6 mm ²
Cable diameter	11.2 mm	13.4 mm	15.4 mm	19.2 mm
Weight	0.24 kg/m	0.37 kg/m	0.52 kg/m	0.77 kg/m

Ordering information

Item no.	Cross section	Length per reel	Reel flange size
85173020	6 mm ²	1000 m	100 cm
85173021	10 mm ²	1000 m	110 cm
85173926	16 mm ²	1000 m	120 cm
85173058	25 mm ²	1000 m	140 cm

Discrete power feeders for single RRH

2 core power cable with braided copper shielding, brown and blue insulation and CPR class D_{ca}

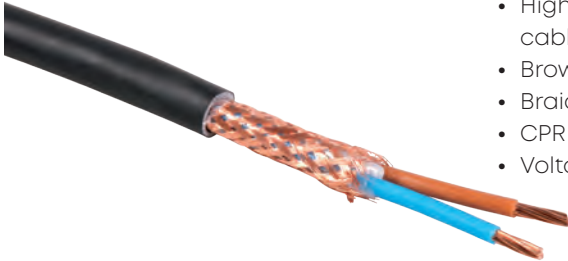

Features

- Highly flexible power cable with low bending radius and excellent cable routing properties
- Brown and blue XLPE insulation
- Braided copper shielding
- CPR compliant class D_{ca}
- Voltage rating 600 V

Specifications

Jacket material	LSFH
Insulation material	XLPE
Insulation color	brown, blue
Screen	braided copper wires coverage 65 to 85%
UV-resistant	according to EN ISO 4892-2
CPR classification	Dca-s1,d2,a1
Standard	IEC 60502-1
Rated voltage	0.6/1.0 kV
Temperature range	-40 to 85°C
Conductor type IEC 60228	annealed copper class 5
Conductor type IEC 60228	Annealed copper class 5

Conductor cross section	6 mm ²	10 mm ²	16 mm ²	25 mm ²
Conductor resistance	3.30 Ω/km	1.91 Ω/km	1.21 Ω/km	0.78 Ω/km
Maximum current rating at 60 °C ambient temperature	45 A	61 A	80 A	105 A
Drain wire cross section	5 mm ²	6 mm ²	7 mm ²	9 mm ²
Cable diameter	13.7 mm	15.5 mm	17.6 mm	21.2 mm
Weight	0.31 kg/m	0.42 kg/m	0.55 kg/m	0.78 kg/m

Ordering information

Item no.	Cross section	Length per reel	Reel flange size
85138936	6 mm ²	1000 m	100 cm
85138937	10 mm ²	1000 m	110 cm
85092557	16 mm ²	1000 m	120 cm
85092563	25 mm ²	1000 m	140 cm

Discrete power feeders for single RRH

2 core power supply cable PVC jacket material, UL listed (TC-ER)

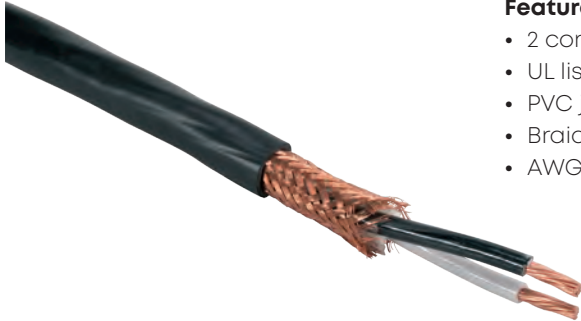

Features

- 2 core copper cable for RRH power supply
- UL listed tray cable TC-ER
- PVC jacket material
- Braided copper shield
- AWG 10 to AWG 2 conductors

Specifications

Jacket material	PVC
Conductor type	copper stranded, class C, type THHN/THWN-2
Insulation material	PVC
Insulation colour	black, white
Screen	braid copper shield, coverage 65 to 85 %
Rated voltage	0.6/1.0 kV
Temperature range	-40 to 90 °C
Minimum bending radius	10 × outer diameter 8 × outer diameter

Cross section	AWG 12	AWG 10	AWG 8	AWG 6	AWG 4
Resistance	1.65 Ω/kft	1.04 Ω/kft	0.64 Ω/kft	0.39 Ω/kft	0.25 Ω/kft
Maximum current rating at 50°C ambient temperature	25 A	33 A	45 A	62 A	88 A
Cable diameter	0.41" (10.3 mm)	0.47" (11.8 mm)	0.59" (15.9 mm)	0.69" (17.6 mm)	0.87" (22.0 mm)
Cross section braid	AWG 12	AWG 10	AWG 10	AWG 8	AWG 8
Weight	88 lbs/kft	124 lbs/kft	205 lbs/kft	353 lbs/kft	551 lbs/kft

Ordering information

Cross section	AWG 12	AWG 10	AWG 8	AWG 6	AWG 4
Item number	85020805	85020806	85020807	85086434	85086435

MASTERLINE Ultimate (MLU)



Multi-riser cable with compact connector head

MASTERLINE Ultimate is the most innovative fiber optic cabling system of HUBER+SUHNER for remote radio installations. The pre-connectorised factory-sealed fiber optic systems support up to 12 RRHs and connect the remote radios with easy-to-install Q-ODC fiber optic jumpers.

The robust connector head with an integrated pulling eye allows easy cable lifting without the need for hoisting grips. The encapsulated connector head can be directly attached to the mast with a single „click“ at a pre-mounted adaptor plate.

MASTERLINE Ultimate is available with Q-ODC-12/24 (MLUQ), a 12 or 24 fiber outdoor connector, instead of a hardwired multi-riser cable. MLUQ allows the use of RRH/antenna pole mount frames to further reduce on-site installation time.

These unique features make MASTERLINE Ultimate the best-in-class product in terms of ease of mast-top installation, installation robustness and efficiency.

MASTERLINE Ultimate (MLU)

RF LISCA RF jumper
page 162



FTTA Q-ODC RRH jumpers
page 30



PTTA Power jumpers
page 43



FTTA MASTERLINE Ultimate with Q-ODC-2
MASTERLINE Ultimate with Q-ODC-24
page 26



PTTA MASTERLINE Ultimate Power
page 38



XTTA Cable clamps
page 134



FTTA Overlength box
page 127



FTTA CTB 19" patching box
page 130



FTTA LC patchcord
page 133

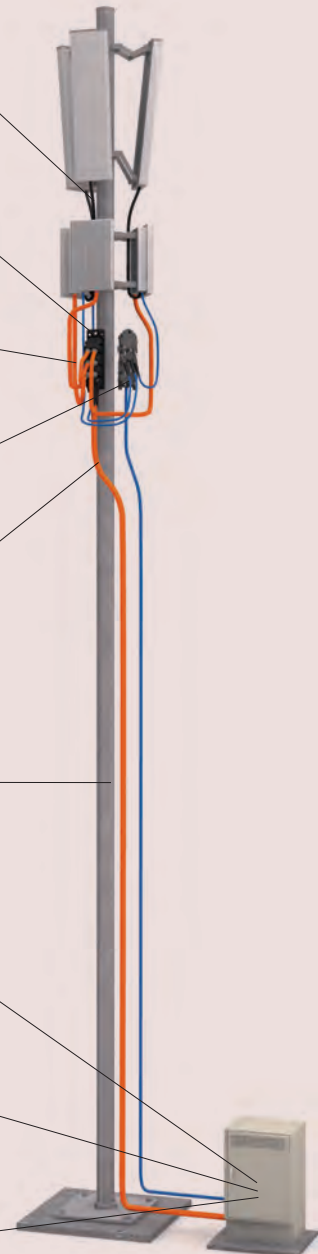
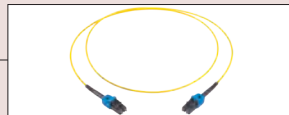

XTTA FTTA, PTTA and HTTA

PTTA Power-To-The-Antenna

RF Radio Frequency

HTTA Hybrid-To-The-Antenna

FTTA Fiber-To-The-Antenna

MASTERLINE Ultimate (MLU)



Features

- Pre-connectorised factory-sealed „plug & play“ fiber optic cabling system for up to 12 RRHs
- Robust connector head with 6 or 12 Q-ODC sockets
- Connects the RRH with easy-to-install Q-ODC fiber optic jumpers
- Integrated pulling eye for easy cable lifting
- Loose tube cables with up to 24 fibers, rodent protected and UV resistant and CPR compliant
- Connectors numbered for easy channel identification
- Easy and time-saving installation

Specifications

Number of Q-ODC connector socket		6 or 12 (specifications see page 145)
Dimensions L x W x H	enclosure without cover	293 x 110 x 46 mm
	enclosure with cover	460 x 160 x 110 mm
Temperature range	during installation	-10 up to +50 °C
	in service	-40 up to +75 °C
Ingress protection		IP67
Impact resistance		IK 07
UV resistant for outdoor use		ISO 4892-3
Cable type		glass-armoured multifiber loose tube cable
Jacket material		LSFH™, black
Cable diameter		7.0 mm
Minimum bending radius	during installation	110 mm
	in service	70 mm
Cable flame resistance	IEC 60332-1 IEC 60332-3-24	passed
CPR compliant		class D _{co} , s1a, d0, a1
Protection tube BTS side	outer diameter	36 mm



MASTERLINE Classic with LC uniboot at BTS side



Protective cover for connector is optional available

MASTERLINE Ultimate (MLU)

Ordering information

MASTERLINE Ultimate with Q-ODC sockets and LC uniboot connectors



Length	Item no. Fiber type: single-mode E9/125 A2 (G.657.A2)				Item no. Fiber type: multimode G50/125 OM3	
	Cable type: LSFH™, CPR D _{ca}		Cable type: LSFH™, UL listed		Cable type: LSFH™, CPR D _{ca}	
	12 fibers – 6 RRH	24 fiber – 12 RRH	12 fibers – 6RRH	24 fibers – 12 RRH	12 fibers – 6 RRH	24 fibers – 12 RRH
20 m	85019356	85019892	85183908	85019905	85087480	85087490
30 m	85019357	85019893	85183909	85019906	85087481	85087491
40 m	85019358	85019894	85183910	85183957	85087482	85087492
50 m	85019359	85019895	85183911	85183958	85087483	85087493
60 m	85019360	85019896	85183912	85019911	85087484	85087494
70 m	85019361	85019897	85183913	85183960	85087485	85087495
80 m	85019362	85019898	85183914	85183961	85087486	85087496
90 m	85019363	85019899	85183915	85184010	85087487	85087497
100 m	85019364	85019900	85183916	85019916	85087488	85087498
125 m	85019365	85019901	85183917	85184012		
150 m	85019366	85019902	85183919	85184015		
200 m	85019367	85019903	85183920	85184766		

Up to 80 m supplied as air ring and for longer cable systems on a double-flange reel.

Option:

- Other length
- With integrated CWDM or DWDM modules (MASTERLINE Ultimate WDM)

MASTERLINE Ultimate WDM (MLU WDM)

MASTERLINE Ultimate WDM is an extended product version based on MASTERLINE Ultimate, with integrated CWDM or DWDM modules.

The plug&play connector head works as a multiplexer for outdoor applications.

It provides 6 or 12 consecutive output channels to connect RRH with vendor specific Q-ODC fiber optic jumpers.

MLU WDM allows a quick and efficient network upgrade when it comes to fiber exhaustion or limited fiber backhaul opportunities.

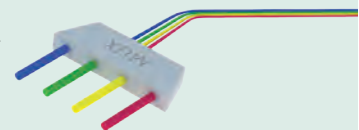

Please see more on page 246.



MLU installation

Easiest-to-install fiber optic product available on the market.

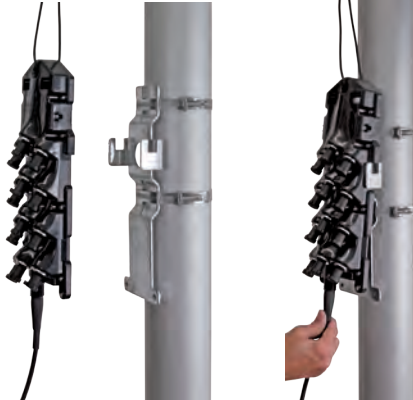
Installation features

	<p>Pulling The robust connector head with integrated pulling eye allows for easy cable lifting without the need for hoisting grips. The small form factor allows pulling of the connector head even inside of a mono pole.</p> <p>Mounting bracket The MLU connector head can be locked easily to the mounting bracket. The bracket has provision for fixation either to a mast or directly onto a wall.</p>
	<p>Q-ODC push-pull connector The Q-ODC push-pull connector allows for a quick and reliable connection of the remote radio head with jumper cables. The Q-ODC connector is used by an ever-growing number of operators and OEMs world-wide.</p>
	<p>Protection tube on BTS side Supplied with robust protection tube to protect the fibers breakouts on BTS side from damage during installation. Can be easily removed by pulling the rip cord.</p>

NEW: MASTERLINE Ultimate with ODC-2

MASTERLINE Ultimate fiber optic cabling system is also available with ODC-2 connector sockets. The ODC-2 connector has a screwed locking mechanism, instead a push-pull coupling mechanism like Q-ODC-2 connector.

Specifications see page 149.



MASTERLINE Ultimate (MLU)

Q-ODC connectors



Q-ODC plug on the jumper

Features

- Robust push-pull coupling mechanism – two clearly defined mating states
- Highest outdoor installation safety
- Available for all types of RRH
- Waterproof, dust proof and corrosion resistant; does not require secondary wrapping



Q-ODC socket on MLU head

Specifications see page 144.

Mating/un-mating sequences



Push plug connector slightly into socket connector, rotate to find keying position, push connector to mate.



Mated – connector snaps in and is fully strain relieved.



Pull coupling ring to un-mate.

Easiest-to-install fiber cabling system

The robust connector head with an integrated pulling eye allows easy cable lifting. The encapsulated connector head can be directly attached to the mast with a single «click» at a pre-mounted adaptor plate.

MLU offers highest variability and security in connecting remote radio units to the fiber optic network. With the unique shape of the top end and the additional protection cover this new connection system is providing a streamline shaped appearance that provides less wind load.

These unique features make MASTERLINE Ultimate the best-in-class product in terms of ease of mast-top installation, installation robustness and efficiency.

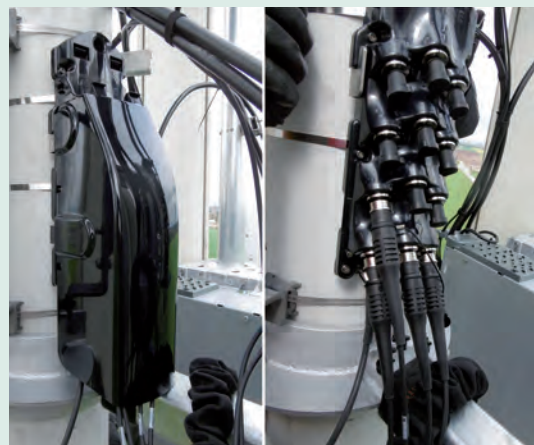

MASTERLINE Ultimate (MLU)

Q-ODC RRH jumpers



Features

- Compatible with MLE, MLEH, MLU and MLUH terminated with Q-ODC
- Ruggedised and robust RRH jumper cable – easy and reliable to install
- Available for all types of RRH
- Cable diameter 4.8 mm, 5.5 mm or 7 mm
- Standard lengths of 2, 5 and 10 m, customised lengths available
- Ingress protection IP67 (Q-ODC)
- Tensile load 450 N (Q-ODC)

Ordering information

Q-ODC plug to LC duplex jumper with metal divider and ruggedised break-out 90 mm long, Ø 4.8 mm cable



Length	Item no. single-mode E9/125 A2 (G.657.A2)
	CPR D _{ca} and UL listed OFNR
2 m	85069805
5 m	85069806
10 m	85069807

Q-ODC plug to LC duplex jumper with moulded divider and ruggedised break-out 98 mm long, Ø 4.8 mm cable



Length	Item no. single-mode E9/125 A2 (G.657.A2)
	CPR D _{ca} and UL listed OFNR
2 m	85032280
5 m	85032282
10 m	85032283

Q-ODC plug to FullAXS, cable Ø 4.8 mm



Length	Item no. single-mode E9/125 A2 (G.657.A2)
	CPR D _{ca} and UL listed OFNR
2 m	85006042
5 m	85006043
10 m	85006044

MASTERLINE Ultimate (MLU)

Ordering information

Q-ODC plug to LC duplex jumper with ruggedised break-out 85 mm long, cable Ø 5.5 mm



Length	Item no. single-mode E9/125 A2 (G.657.A2)	Item no. multimode G50/125 OM3
	CPR D _{ca}	CPR D _{ca}
2 m	85002962	85002965
5 m	85002963	85002966
10 m	85002964	85002967

Q-ODC plug to LC duplex jumper with ruggedised break-out 90 mm long, Ø 7.0 mm cable



Length	Item no. single-mode E9/125 A1 (G.657.A1)	Item no. multimode G50/125 OM3
	CPR D _{ca}	CPR D _{ca}
2 m	84204528	85002972
5 m	84204530	85002973
10 m	84204532	85002974

Q-ODC plug to PDLC, cable Ø 7.0 mm



Length	Item no. single-mode E9/125 A1 (G.657.A1)
	CPR D _{ca}
2 m	84204521
5 m	84204523
10 m	84204525

Q-ODC plug RRH jumpers to other OEM interfaces

Please contact HUBER+SUHNER for Q-ODC plug RRH jumpers for other OEM interfaces which are not listed above.

MASTERLINE Ultimate with Q-ODC-12/24 (MLUQ)



Features

- Pre-connectorised factory-sealed “plug & play” fiber optic cabling system for up to 12 RRHs
- Modular RRH installation solution – connector head and multifiber cable can be installed separated
- Q-ODC-12 or Q-ODC-24 connectivity between the connector head and multifiber cable
- Connectorised multifiber cable can be installed through a hole with a minimum diameter of only 22 mm
- Robust connector head with 6 or 12 Q-ODC-2 sockets to connect the RRH with Q-ODC-2 fiber optic jumpers
- Easy and time-saving installation

Specifications

Connector head		
Number of Q-ODC-2 connector socket		6 or 12
Number of Q-ODC-12/24 connector socket (reverse plug)		1
Dimensions L × W × H	enclosure without cover	293 × 110 × 46 mm
	enclosure with cover	460 × 160 × 110 mm
Temperature range	during installation	-10 up to +50 °C
	in service	-40 up to +75 °C
Ingress protection		IP67
Impact resistance		IK 07
UV resistant for outdoor use		ISO 4892-3
Mounting bracket material		stainless steel

Multifiber cable		
Cable type		glass-armoured multifiber loose tube cable
Jacket material		LSFH™, black
Cable diameter		7.0 mm
Minimum bending radius	during installation	110 mm
	in service	70 mm
Fire propagation		IEC 60332-1 and IEC 60332-3-25
CPR compliant		class D _{co} s1a, d0, a1



Protective cover for connector is optional available

MASTERLINE Ultimate installation

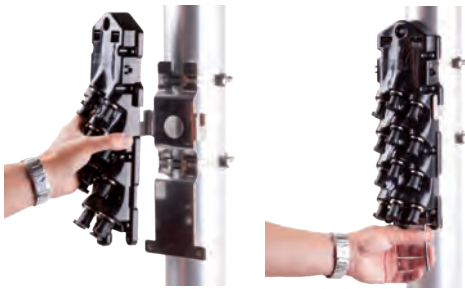

Hook in MLU head to mounting bracket

The MLU connector head can be easily hooked in to the pre-mounted bracket and firmly fixed with two captive screws at the bottom of the connector head.



Lift the connectorised multifiber cable

Use the integrated pulling eye at the Q-ODC12/24 connector cap to lift the multifiber cable, connectorised with Q-ODC-12/24 extension, up to the mast.

Connect the Q-ODC-12/24 extension to the Q-ODC-12/24 socket (reverse plug) at the bottom of the MLUQ.

Modularity for reduced on-site installation

MASTERLINE Ultimate with Q-ODC-12/24 (MLUQ) is a modular cabling system which allows the use of RRH/antenna pole mount frames. A multifiber cable connectorised with Q-ODC-12/24 extension on the top side is installed at the mast or pole separately from the RRH installation.

The operator builds it's frames with the RRHs, antennas and MLUQ connector head at their logistics centers. Usually 3 or 4 Radios are installed on a pole mount frame (a frame per sector or frequency). At the site the whole radio/antenna frame is lifted up and fixed to the mast and with one click the MLUQ connector head (for up to 12 RRHs) gets connected via the Q-ODC-12/24 connector and multifiber cable fed down to the BBU.



MASTERLINE Ultimate (MLUQ)

Q-ODC-12/Q-ODC-24 connector



Features

- Up to 24 fibers, single-mode or multimode
- Compact design with MT ferrules
- Robust push-pull coupling mechanism – two clearly defined mating states
- Highest outdoor installation safety
- Waterproof, dust proof and corrosion resistant
- Waterproof protection caps available

Q-ODC-12/24 extension terminated to the multifiber cable and Q-ODC-12/24 socket (reverse plug) on the MLUQ enclosure

Specifications on page 147.

Mating/unmating sequences



Un-mate protection cap with pulling eye

Pull back metal coupling ring at the Q-ODC-12/24 protection cap and remove protective cap



Mating sequence

Push extension connector slightly into socket (reverse plug) connector, rotate to find keying position, push connector to mate. Use arrows on the boot for pre-alignment. Mated – connector snaps in and is fully strain relieved.



Un-mating sequence

Push black rubber coupling ring at the MLUQ socket (reverse plug) to unmate. Replace dust protection caps.

Q-ODC-2 connector



Features

- 2 fibers, single-mode or multimode
- Compact design with 2 × 1.25 mm ferrules
- Robust push-pull coupling mechanism – two clearly defined mating states
- Highest outdoor installation safety
- Waterproof, dust proof and corrosion resistant
- Waterproof protection caps available
- Fulfills performance standard IEC 61753-1 Cat. E

Specifications and mating/unmating sequences on page 143.

MASTERLINE Ultimate with Q-ODC-12/24 (MLUQ)

Ordering information

MASTERLINE Ultimate with Q-ODC-12/24 (MLUQ) and multifiber cable connectorised with Q-ODC-12/24 extension and 6/12 × LC duplex connector



MLUQ connector head

Item no. MLUQ connector head with 12 fiber, 6 × Q-ODC-2 socket and 1 × Q-ODC-12 socket (reverse plug) including mounting bracket Fiber type: single-mode E9/125 A2 (G.657.A2)	Item no. MLUQ connector head with 24 fiber, 12 × Q-ODC-2 socket and 1 × Q-ODC-24 socket (reverse plug) including mounting bracket Fiber type: single-mode E9/125 A2 (G.657.A2)
85089691	85089688

Connectorised multifiber cable

Length	Item no. Multifiber cable connectorised with Q-ODC-12 extension and 6 × LC duplex connector, 12 fiber Fiber type: single-mode E9/125 A2 (G.657.A2)	Item no. Multifiber cable connectorised with Q-ODC-24 extension and 12 × LC duplex connector, 24 fiber Fiber type: single-mode E9/125 A2 (G.657.A2)
20 m	85032143	85096335
30 m	85032144	85096336
40 m	85032145	85096337
50 m	85032146	85096338
60 m	85032147	85096339
70 m	85032148	85096340
80 m	85032149	85096341
90 m	85032150	85096342
100 m	85032151	85096343









Q-ODC-12/24 extension with pulling eye cap



MASTERLINE Classic with LC duplex connector at BTS side

MASTERLINE Ultimate (MLU)

Accessories

Description		Item no.	Page	Picture
Protective cover for connector head		85108554	--	
Overlength box for outdoor and indoor installation, stores up to 20 m cable excess length (depending on cable diameter)		84103325	127	
Combined clamps for fiber optic and power cable		depends on cable diameter	134	
19" CTB patching box	6, 12, 18 or 24 LC duplex adapter blue	depends on quantity of LC adapter	130	
LC patchcords	0.5 m, 0.7 m or 1 m length, single-mode	depends on length	133	
Quick hose clamps. Stainless steel. One set includes 2 pieces hose clamps.	clamping Ø 30 to 155 mm	84076411	140	
	clamping Ø 60 to 500 mm	84076412		
SFP/SFP+ transceivers for different protocols, data rates and power budgets.		See transceiver selection guide on page 260	259	



MASTERLINE Ultimate Power (MLUP)



Multi-wire power cable with compact connector head

MASTERLINE Ultimate Power enables a power supply installation with only one power cable, instead of 6 individual power cables. The compact pre-connectorised head supplies -48 Vdc for up to 6 RRHs.

Power jumpers, available in different lengths, connect the RRHs with -48 Vdc. A pre-laced hoisting grip below the robust connector head allows for easy cable lifting. The encapsulated connector head can be directly attached to the mast at a pre-mounted adaptor plate.

MASTERLINE Ultimate Power (MLUP)

RF LISCA RF jumper
page 162



FTTA Q-ODC RRH jumpers
page 30



PTTA Power jumpers
page 43



FTTA MASTERLINE Ultimate
page 24



PTTA MASTERLINE Ultimate Power
page 38



XTTA Cable clamps
page 134



FTTA Overlength box
page 127



FTTA CTB 19" patching box
page 130



FTTA LC patchcord
page 133

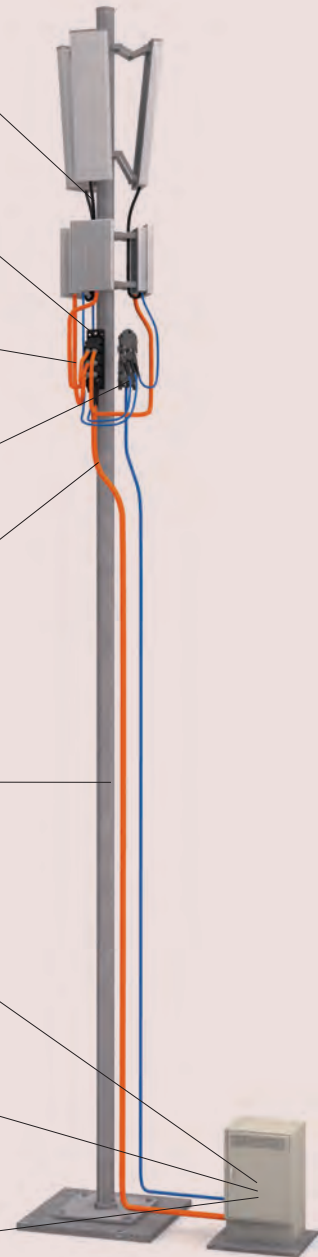
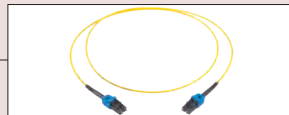

XTTA FTTA, PTTA and HTTA

RF Radio Frequency

FTTA Fiber-To-The-Antenna

PTTA Power-To-The-Antenna

HTTA Hybrid-To-The-Antenna

MASTERLINE Ultimate Power (MLUP)



Features

- Pre-connectorised factory-sealed power cabling system for up to 6 RRHs
- Modular „plug & play“ system with 6 power connectors
- Highly flexible 12-core power cable 6 mm² to 16 mm² and AWG 10 to AWG 6
- Hoisting grip for cable lifting
- Mounting bracket for easy mast-, pole-, and wall-installation
- Space-efficient, low wind-load
- Integral earth point which can be connected to an earth lead with M8 ring terminal

Connector head specifications

Number of power connector (rugged circular plastic socket)	6	
Maximum current rating	up to 42 A per power socket (depending on the conductor cross section selected)	
Dimensions L × W × H	310 × 90 × 97 mm	
Ambient temperature range	during installation	-10 up to +50 °C
	in service	-40 up to +75 °C
Ingress protection (IEC 60529)	IP67	
Impact resistance (IEC 62262)	IK 10	
Material housing	high-performance polycarbonate	
UV resistance, ISO 4892-3 (methode A/cylce 1)	1000 h	
Material flammability rating	UL94-V0	

Power cable specifications

	LSFH™ power cable, global market			UL listed power cable, US market		
Jacket material	thermoplastic, LSFH™			PVC		
Rated voltage	0.6 kV/1 kV (1.2 kV)			0.6 kV/1 kV (1.2 kV)		
Conductor type	IEC 60228 class 5			class C THHN/THWN-2		
Cable shielding	braided screen of copper wires			copper foil		
CPR compliant	yes, class D _{ca}			no		
Number of conductor	12					
Conductor cross section	6 mm²	10 mm²	16 mm²	AWG 10	AWG 8	AWG 6
Resistance	3.30 Ω/km	1.91 Ω/km	1.21 Ω/km	3.41 Ω/km	2.13 Ω/km	1.30 Ω/km
Maximum current rating	25 A	35 A	42 A *	16 A	23 A	31 A
Outer diameter	23.7 mm	27.4 mm	32.2 mm	23.5 mm (0.93")	29.5 mm (1.16")	33.5 mm (1.32")
Weight	1.06 kg/m	1.58 kg/m	2.20 kg/m	1.14 kg/m	1.64 kg/m	2.33 kg/m
Shielding/drain wire cross section	8 mm ²	10 mm ²	14 mm ²	AWG 6	AWG 6	AWG 6

* limitation through power connector maximum current rating 42 A (IEC) and 44A (UL)

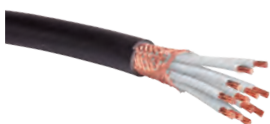

12-core power cable

MASTERLINE Ultimate Power (MLUP)

Power connectors



Power connector plug at the jumper



Power connector flange socket at the MLUH connector head

Features

- Rugged circular plastic plug connector for remote radio installations
- Machined crimp contacts Ø 3.6 mm for high current
- Bayonet coupling system for easy and quick mating
- 2 wire shielded copper cable with cross section of 4 or 6 mm²
- 3-pol connector for 2-wire shielded copper cable

The bayonet coupling system enables a simple and fast mating. With only a 1/3 twist of the coupling ring, connectors are mated with an audible and tactile „click“. The machined 3.6 mm crimp contacts ensure a vibration safe termination and a high current rating.

Mating/unmating sequences



Twist the coupling ring of the plug connector to remove protecting cap as shown.



Push plug connector slightly into flange connector, rotate to find keying position, twist coupling ring of the plug connector as shown.



Twist coupling ring as shown to unmate the plug connector.

Power connector specifications

Maximum current rating	42 A (IEC), 44 A (UL), 30 A (CSA)
Rated voltage	230 V (IEC), 600 V (UL), 600 V (CSA)
Operating temperature	-40 to 105 °C (40/10/21 per NFF 61-030)
Flammability rating	UL 94 V0
Salt spray	> 500 hours
UV resistant for outdoor use	ISO 4892
Ingress protection mated	IP67 (EN 60529)
Dimensions	Ø 35.1 mm, length 70 mm
Cable diameter range	5 to 14 mm
Material body connector and backshell	thermoplastic, halogen-free
Crimp contacts	machined Ø 3.6 mm
Material crimp contacts	copper alloy, plating 2 µ Ni + 2 µ Ag
Mating cycles	100
RoHS compliant	yes
Compliance	UL1977: certificate ECBT2 file number E169916 CSA C22.2 n°182.3: certificate ECBT8 file number E169916

MASTERLINE Ultimate Power (MLUP)

Ordering information



RRH side	BTS side
6 rugged circular plastic sockets	6 pairs of wires blunt cut wire cross section 6 mm ² , 10 mm ² , 16 mm ² , AWG 10, AWG 8, AWG 6

Market	Length	Item no.		
		6 mm ²	10 mm ²	16 mm ²
Global CPR class D _{co}	30 m	85098414		
	40 m	85098415	85120913	
	50 m	85098416	85119794	
	60 m		85098417	
	70 m		85098418	85120920
	80 m		85098419	85120921
	90 m		85098420	85120922
US UL listed		AWG 10	AWG 8	AWG 6
	30 m	85098421		
	40 m	85098422		
	50 m	85098423		
	60 m		85098424	
	70 m		85098425	85142088
	80 m		85098426	85142089
	90 m		85098427	85142090

Option:
 · Other length

Accessories

Description	Item no.	Page	Picture
Clamps for hybrid cable	depends on cable diameter	136	
Grounding kits	85015070	138	
Grounding cable, 0.5 m, 16 mm ² and 25 mm ² , black and yellow/green	depends on cross section and colour	139	
Auxiliary tool to open and close power connector	85013939	--	
Protection cover for MLUH 3 Stainless steel Dimension (L x H x W) 365 x 200 x 90 mm	85032157	--	

MASTERLINE Ultimate Power (MLUP)

Power jumpers



Features

- Compatible with MLUP, MLEP, MLUH and MLUH
- Terminated with a rugged circular plastic plug connector and blunt cut on the RRH side
- 2 wire shielded copper cable with a cross section of 4 mm² to 10 mm² and AWG 10 to AWG 8
- Standard length 2, 5 and 10 m

Specifications

	Global market			UL listed US market		
Jacket material	LSFH™			PVC, flame retardant		
Conductor type	4 mm ² IEC 60228 class 2, 6 mm ² /10 mm ² IEC 60228 class 5			THHN/THWN-2, class C		
Insulation colour	blue, brown			black, white		
Cable shielding	braided screen of copper wires, coverage 65 to 85 %					
Rated voltage	0.6/1.0 kV					
Number of conductor	2					
Conductor cross section	4 mm²	6 mm²	10 mm²	AWG 12	AWG 10	AWG 8
Resistance	4.61 Ω/km	3.30 Ω/km	1.91 Ω/km	1.65 Ω/kft	1.04 Ω/kft	0.64 Ω/kft
Maximum power current	34 A	42 A *	42 A *	25 A	33 A	44 * A
Cable diameter	10.7 mm	12.1 mm	13.3 mm	0.41" (10.3 mm)	0.47" (11.8 mm)	0.524" (13.3 mm)
Cross section shielding	4 mm ²	5 mm ²	6 mm ²	AWG 12	AWG 12	AWG 10

* limitation through power connector maximum current rating 42 A (IEC)/44 A (UL)

Ordering information



Market	Length	Item no.		
Global		4 mm²	6 mm²	10 mm²
	2 m	85006013	85006015	85109382
	5 m	84149463	84149464	85109384
	10 m	85006014	85006016	85109386
US UL listed		AWG 12	AWG 10	AWG 8
	2 m	85086893	85086894	85142464
	5 m	85086575	85086895	85142465
	10 m	85080185	85086896	85142466

MASTERLINE Extreme (MLE)



Multi-riser cable with compact divider

MASTERLINE Extreme with Q-ODC-2 connectors is an efficient solution in terms of ease of installation, cost and required space on the mast. The compact divider minimises the wind-load and can be fed through small holes (80 mm diameter). The ruggedised push-pull connector Q-ODC allows the installer to connect the RRH jumper cables with a single „click“, making it a genuine „plug & play“ cabling system. MLE with Q-ODC is available to support up to 12 remote radios.

MASTERLINE Extreme with one Q-ODC-12 connector allows the installer to connect 6 RRH jumper cables with a single „click“ and can even be installed through holes with a diameter of 20 mm. The Q-ODC-12 connector has the highest fiber density, based on the proven QN push-pull mating system and can connect 12 fibers in one mating step.

MASTERLINE Extreme is the preferred choice of network installers who require trouble free, reliable and efficient field deployments. MASTERLINE Extreme product family of HUBER+SUHNER is unique in the market and provides the best value for money.

MASTERLINE Extreme (MLE)

RF LISCA RF jumper
page 162



FTTA Q-ODC RRH jumper
Q-ODC-12 RRH jumper
page 30, 50



PTTA Power jumpers (optional)
page 43



FTTA MASTERLINE Extreme with Q-ODC
MASTERLINE Extreme with Q-ODC-12
page 46, 49



PTTA MASTERLINE Extreme Power
page 54



XTTA Cable clamps
page 134



FTTA Overlength box
page 127



FTTA CTB 19" patching box
page 130



FTTA LC patchcord
page 133

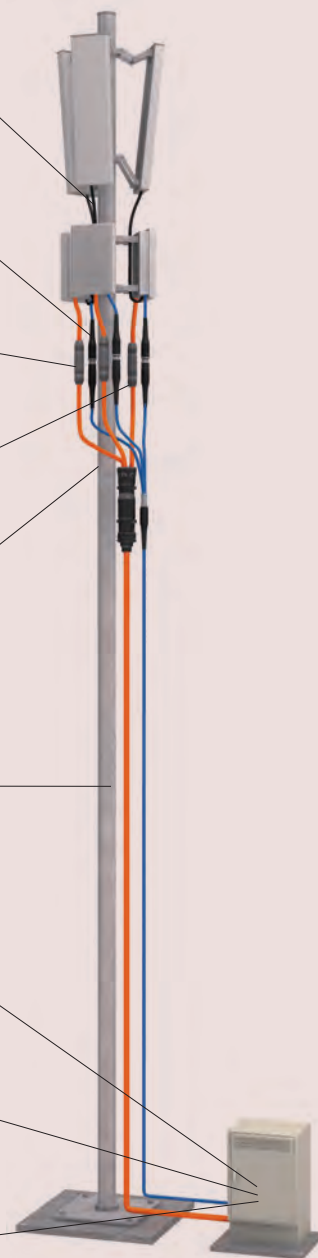
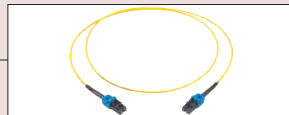

XTTA FTTA, PTTA and HTTA

PTTA Power-To-The-Antenna

RF Radio Frequency

HTTA Hybrid-To-The-Antenna

FTTA Fiber-To-The-Antenna

MASTERLINE Extreme (MLE) with Q-ODC



Features

- Pre-assembled „plug & play“ cabling system
- Terminated with Q-ODC extension connectors on RRH side
- Adaptation to any RRH interface with Q-ODC plug jumpers
- BTS side terminated with LC uniboot connectors
- Ruggedised design with robust break-out cables
- Robust pulling tube for cable lifting
- Loose tube cables with 12 or 24 fibers, rodent protected and UV resistant and CPR compliant
- Connectors numbered for easy channel identification
- Easy and time-saving installation

Specifications

Number of fibers		12	24
Build-in hole dimension divider BTS side		15.6 to 16.4 mm	
Outer diameter divider	RRH side	22.0 mm	28.0 mm
Tensile load on individual break-out cables		600 N	
Ingress protection with Q-ODC connector		IP67	
Break-out lengths		0.55/0.64 m	0.55/0.64/0.73/0.82 m
Break-out cable diameter		5 mm	
Cable type		glass-armoured multifiber loose tube cable	
Jacket material		LSFH™, black	
Cable diameter		7.0 mm	
Temperature range	installation	-10 to +50 °C	
	in service	-40 to +75 °C	
Fire propagation		IEC 60332-1 and IEC 60332-3-25	
CPR compliant		class D _{co} s1a, d0, a1	
Flame resistance	IEC 60332-1	passed	
	IEC 60332-3-24		
Pulling tube with pulling eye	outer diameter	60 mm	
Protection tube BTS side	outer diameter	36 mm	



LC uniboot at BTS side



Protecting tube at BTS side



Pulling tube with pulling eye

MASTERLINE Extreme (MLE) with Q-ODC

Q-ODC connectors



Q-ODC plug on the jumper



Q-ODC extension on the MLE

Features

- Robust push-pull coupling mechanism – two clearly defined mating states
- Highest outdoor installation safety
- Waterproof, dust proof and corrosion resistant; does not require secondary wrapping

Mating/unmating sequences



Push plug connector slightly into extension connector, rotate to find keying position, push connector to mate.



Mated – connector snaps in and is fully strain relieved.



Pull coupling ring to unmate.

Q-ODC RRH jumpers



Features

- Compatible with MLE, MLEH, MLU and MLUH terminated with Q-ODC
- Ruggedised and robust RRH jumper cable – easy and reliable to install
- Available for all types of RRH
- Cable diameter 4.8 mm, 5.5 mm or 7 mm
- Standard lengths of 2, 5 and 10 m, customised lengths available

For ordering information, please see page 30.

MASTERLINE Extreme (MLE) with Q-ODC

Ordering information

MASTERLINE Extreme with Q-ODC extensions and LC uniboot connectors.



Length	Item no. Fiber type: single-mode E9/125 A2 (G.657.A2)				Item no. Fiber type: multimode G50/125 OM3	
	Cable type: LSFH™, CPR D _{ca}		Cable type: LSFH™, UL listed		Cable type: LSFH™, CPR D _{ca}	
	12 fibers – 6 RRH	24 fiber – 12 RRH	12 fibers – 6 RRH	24 fibers – 12 RRH	12 fibers – 6 RRH	24 fibers – 12 RRH
20 m	85005467	85005609	85004452	85004479	85009293	85014283
30 m	85005468	85005610	85004453	85004481	85009294	85014284
40 m	85005469	85005611	85004454	85004482	85009295	85014285
50 m	85005470	85005612	85004455	85004483	85009064	85014286
60 m	85005471	85005613	85004456	85004484	85009296	85014287
70 m	85005472	85005614	85004457	85004485	85009297	85014288
80 m	85005473	85005615	85004458	85004486	85009299	85014289
90 m	85005474	85170077	85004459	85004487	85009300	85014300
100 m	85005475	85005617	85004460	85004488	85009301	85014301
125 m	85005478	85005620	85004461	85004489	85014280	85014302
150 m	85005479	85005621	85004462	85004490	85014281	85014303
200 m	85005480	85005622	85004463	85004491	85014282	85014304

Options:

- Other length



Supplied on a double-flange reel

MASTERLINE Extreme (MLE) with Q-ODC-12

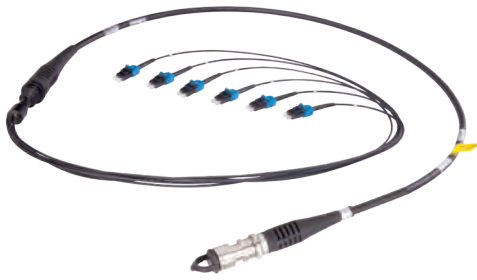

Features

- Pre-assembled „plug & play“ cabling system
- Terminated with Q-ODC-12 extension connectors on RRH side
- Adaptation to any RRH interface with Q-ODC-12 plug connector
- BTS side terminated with LC uniboot connectors
- Ruggedised design with robust break-out cables
- Robust connector cap with pulling eye
- Loose tube cables with 8/12 fibers, rodent protected and UV resistant and CPR compliant
- Connectors numbered for easy channel identification
- Easy and time-saving installation

Specifications

Number of fibers	8/12	
Build-in hole diameter BTS side	15.6 to 16.4 mm	
Outer diameter divider BTS side	22.0 mm	
Break-out cable diameter	5.0 mm	
Ingress protection with Q-ODC 12 (mated)	IP68	
Cable type	yelly-free glass-armoured multifiber loose tube cable	
Jacket material	LSFH™, black	
Cable diameter	7.0 mm	
Temperature range	installation	-10 to +50 °C
	in service	-40 to +75 °C
Fire propagation	IEC 60332-1 and IEC 60332-3-25	
CPR compliant	class D _{co} s1a, d0, a1	
Flame resistance	IEC 60332-1	passed
	IEC 60332-3-24	
Pulling tube with pulling eye	outer diameter	20 mm
	outer diameter	36 mm

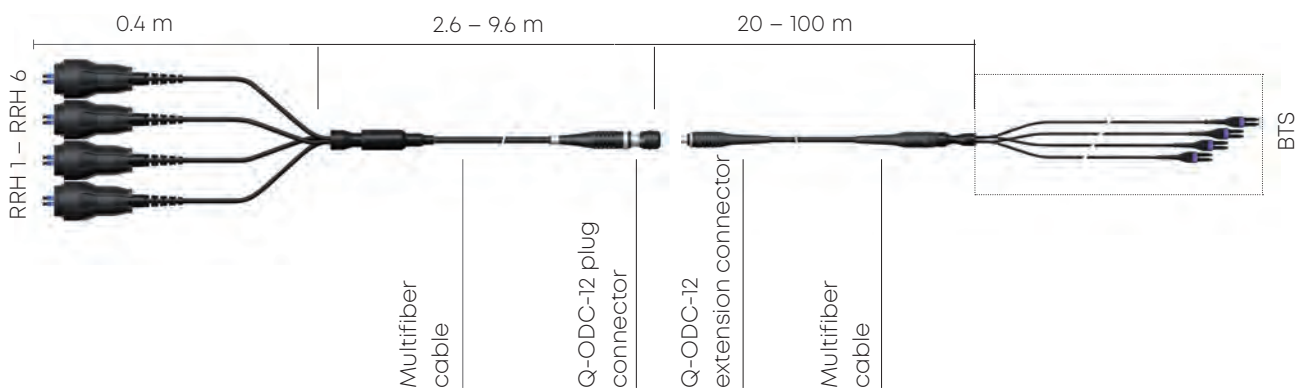

LC uniboot at BTS side



Protecting tube at BTS side

MASTERLINE Extreme (MLE) with Q-ODC-12

Q-ODC-12 connector



Q-ODC-12 plug on the multi-branch RRH jumper

Features

- Connects 12 fibers in one mating step
- Compact design with MT ferrules
- Robust push-pull coupling mechanism – two clearly defined mating states
- Highest outdoor installation safety
- Waterproof, dust proof and corrosion resistant



Q-ODC-12 extension with robust connector cap pulling eye

Specifications on page 147.

Mating/unmating sequences

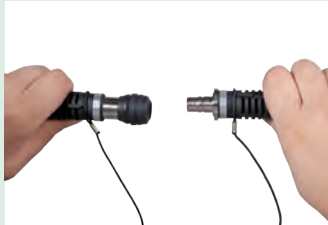

Push plug connector slightly into extension connector, rotate to find keying position, push connector to mate.



Mated – connector snaps in and is fully strain relieved.



Pull coupling ring to unmate.

MASTERLINE Extreme (MLE) with Q-ODC-12

Ordering information

Glass-armoured 8/12 fiber loose tube cable with Q-ODC-12 extension and LC uniboot connectors



Length	Item no. : 8 fiber, single-mode E9/125 A2	Item no. 12 fiber, single-mode E9/125 A2	
	Cable type: LSFH™, CPR D _{ca}	Cable type: LSFH™, CPR D _{ca}	Cable type: LSFH™, UL listed
20 m	85085658	85032143	85032158
30 m	85085663	85032144	85032159
40 m	85085667	85032145	85032160
50 m	85085677	85032146	85032161
60 m	85085680	85032147	85032162
70 m	85085690	85032148	85032163
80 m	85085693	85032149	85032164
90 m	85085698	85032150	85032165
100 m	85085737	85032151	85032166
125 m	85085739	85032152	85032167
150 m	85085740	85032154	85032169
200 m	85085741	85032155	85032170

Option:

- Multimode OM3



Supplied on a double-flange reel

MASTERLINE Extreme (MLE) with Q-ODC-12

Q-ODC-12 multi-branch RRH jumper



Features

- Terminated with Q-ODC-12 plug and with 2 to 6 RRH-specific interfaces
- Connects up to 6 RRH jumper cables with a single „click“
- Ruggedised design with robust break-out cables
- RRH-specific interface numbered for easy channel identification
- Ingress protection IP68 (Q-ODC-12, mated)

Ordering information

Q-ODC-12 multi-branch RRH jumper with 4/6 FullAXS connector and cable Ø 5.0 mm, single-mode fiber

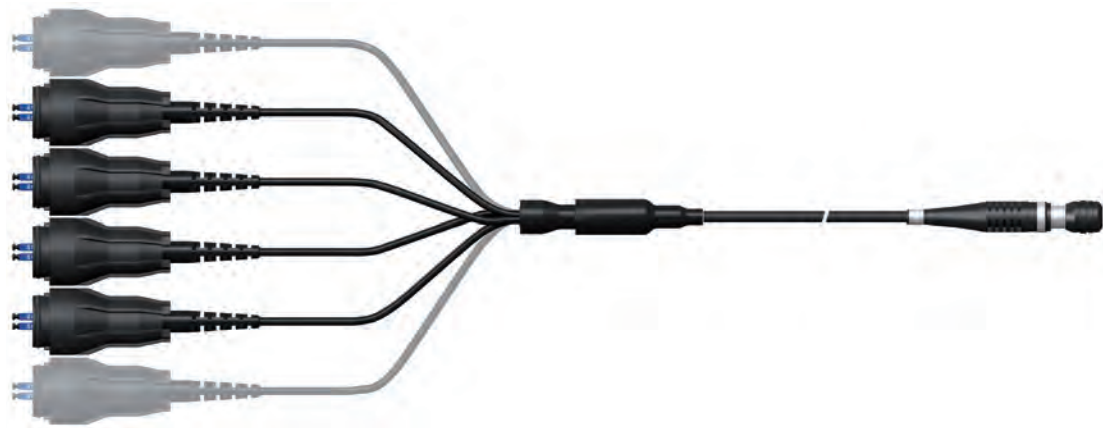

No. of connectors	Total length	Branch break-out length	Item no.
6	3 m	2 m	85031204
4	3 m	0.4 m	85127434

Q-ODC-12 multi-branch RRH jumper with 4/6 LC duplex, moulded divider and ruggedised break-out 90 mm long and cable Ø 5.0 mm, single-mode fiber



No. of connectors	Total length	Branch break-out length	Item no.
6	3 m	2 m	85032210
4	3 m	0.4 m	85127435

MASTERLINE Extreme (MLE)

Accessories

Description		Item no.	Page	Picture
Overlength box for outdoor and indoor installation, stores up to 20 m cable excess length (depending on cable diameter)		84103325	127	
Combined clamps for fiber optic and power cable		depends on cable diameter	134	
19" CTB patching box	6, 12, 18 or 24 LC duplex adapter blue	depends on quantity of LC adapter	130	
LC patchcords	0.5 m, 0.7 m or 1 m length, single-mode	depends on length	133	
3 fold cable clamp suitable for ODC boot to fix the Q-ODC extension connectors		85012939	136	
6 fold cable clamp suitable for ODC boot to fix 6 Q-ODC extension connectors		85066072	134	
Clamp for MLE 12 fiber divider (22 mm)		85015525	136	
Clamp for MLE 24 fiber divider (28 mm)		85013128	136	
SFP/SFP+ transceivers for different protocols, data rates and power budgets.		See transceiver selection guide on page 260	259	

MASTERLINE Extreme Power (MLEP)



Multi-wire power cable with compact divider

MASTERLINE Extreme Power enables -48 Vdc power supply installation with only one power cable, instead of 6 individual power cables. The compact and robust factory sealed divider splits the DC power cable into 6 ruggedised break-out cables, which are linked to the RRHs – either directly or via extension jumpers in different lengths. With a hoisting grip, attached below the divider, the cable system is lifted up to the mast.

MASTERLINE Extreme Power (MLEP)

RF LISCA RF jumper
page 162



FTTA Q-ODC RRH jumper
Q-ODC-12 RRH jumper
page 30, 50



PTTA Power jumpers (optional)
page 43



FTTA MASTERLINE Extreme with Q-ODC
MASTERLINE Extreme with Q-ODC-12
page 46, 49



PTTA MASTERLINE Extreme Power
page 54



XTTA Cable clamps
page 134



FTTA Overlength box
page 127



FTTA CTB 19" patching box
page 130



FTTA LC patchcord
page 133

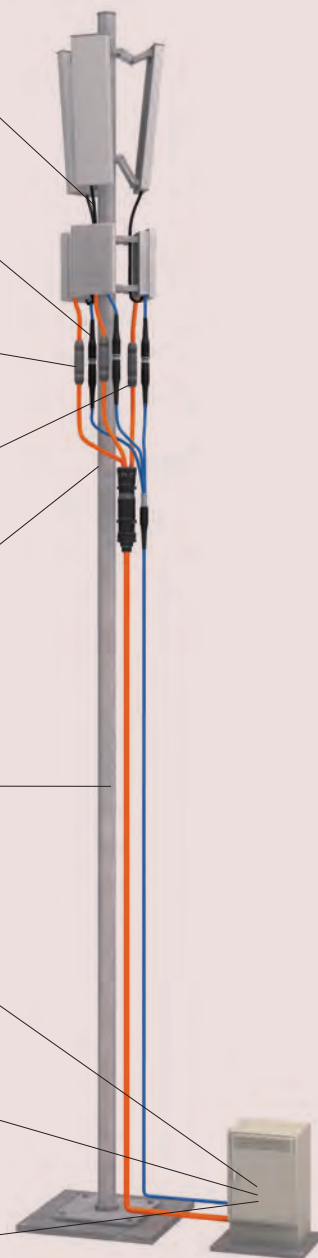
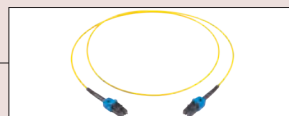

XTTA FTTA, PTTA and HTTA

PTTA Power-To-The-Antenna

RF Radio Frequency

HTTA Hybrid-To-The-Antenna

FTTA Fiber-To-The-Antenna

MASTERLINE Extreme Power (MLEP)



Features

- Power cabling system for up to 6 RRHs
- Ruggedised powder coated aluminum with robust breakout cables
- Highly flexible 12-core power cable 6 mm² to 16 mm² and AWG 10 to AWG 6
- Break-out cable open-end or terminated with power connector
- Hoisting grip on the cable for cable lifting
- Supplied on double-flange reels for straight forward unspooling
- Integral earth point which can be connected to an earth lead with M8 ring terminal
- Optional connectorised power jumpers for higher installation flexibility

Enclosure specifications

Number of break-out power cable	6	
Dimensions	length 253 mm Ø 76 mm	
Housing material	Powder coated aluminum	
Maximum current rating	up to 46 A per RRH (depending on the power cable)	
Temperature range	operation	-40 to +75 °C
	installation	-10 to +50 °C
Ingress protection (IEC 60529)	IP68	
Impact resistance (IEC 62262)	IK 10	
Flammability	UL94-V0	
UV resistance, ISO 4892-3 (methode A/cylce 1)	1000 h	



Hoisting grip for hybrid cable lifting



Mounting bracket with snap-in mechanism for quick and easy fixation of the divider housing. The UV resistant clips can be closed by hand without any tool.

MASTERLINE Extreme Power (MLEP)

12-core power cable specifications

	LSFH™ power cable, global market			UL listed power cable, US market		
Jacket material	thermoplastic, LSFH™			PVC		
Rated voltage	0.6 kV/1 kV (1.2 kV)					
Conductor type	IEC 60228 class 5			class C THHN/THWN-2		
Cable shielding	braided screen of copper wires			copper foil		
CPR compliant	yes, class D _{ca}			no.		
Number of conductor	12					
Conductor cross section	6 mm²	10 mm²	16 mm²	AWG 10	AWG 8	AWG 6
Resistance	3.30 Ω/km	1.91 Ω/km	1.21 Ω/km	3.41 Ω/km	2.13 Ω/km	1.30 Ω/km
Maximum current rating	25 A	34 A	46 A **	16 A	23 A	31 A
Outer diameter	23.7 mm	27.4 mm	32.2 mm	23.5mm (0.93")	29.5mm (1.16")	33.5mm (1.32")
Weight	1.06 kg/m	1.58 kg/m	2.20 kg/m	1.14 kg/m	1.64 kg/m	2.33 kg/m
Shielding/drain wire cross section	8 mm ²	10 mm ²	14 mm ²	AWG 6	AWG 6	AWG 6

* Limitation through 2-core 6 mm² break-out power cable

** 46 A with 10 mm² breakout power cable

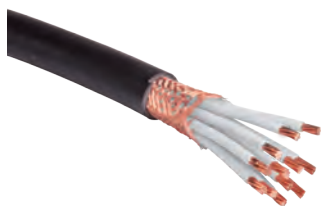

12-core power cable

2-core break-out power cable specifications

	LSFH™ power cable, global market		UL listed power cable, US market	
Jacket material	LSFH™		PVC, flame retardant	
Conductor type	IEC 60228 class 5		class C THHN/THWN-2	
Screen	braided screen of copper wires, coverage 65 to 85 %			
Rated voltage	0.6 kV/1 kV		0.6 kV/1 kV	
Number of conductor	2			
Conductor cross section	6 mm²	10 mm²	AWG 10	AWG 8
Resistance	3.30 Ω/km	1.91 Ω/km	3.41 Ω/km	2.13 Ω/km
Maximum current rating	44 A	61 A	33 A	45 A
Cable diameter	12.1 mm	13.3 mm	0.45" (11.4 mm)	0.524" (13.3 mm)
Cross section braid	5 mm ²	6 mm ²	AWG 10	AWG 10

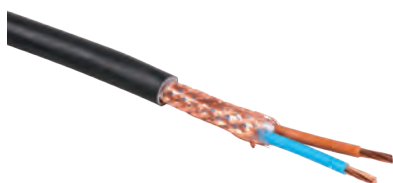

2-core power cable

MASTERLINE Extreme Power (MLEP)

Ordering information

MASTERLINE Extreme for 6 RRHs





Radio end side	BTS side
6 break-out power cable, blunt cut, 6 mm ² /AWG 10, 4 m length	12-core power cable, blunt cut, 6 mm ² , 10 mm ² , 16 mm ² and AWG 10, AWG 8, AWG 6

Market	Length	Item no.	10 mm ²	16 mm ²
global not UL listed CPR class Dca		6 mm²		
	30 m	85006954		
	40 m	85173462		
	50 m	85006956		
	60 m		85173468	
	70 m		85108703	85142121
	80 m		85173470	85142122
			85173471	85142123
		AWG 10	AWG 8	AWG 6
US UL listed	30 m	85006962		
	40 m	85006963		
	50 m	85006964		
	60 m		85006965	
	70 m		85006966	85142124
	80 m		85006967	85142125
	90 m		85006968	85142126

Option:

- Power breakouts with power connector
- Other length
- 10 mm² or AWG 8 power breakouts
- MLEP with 3 or 9 break-out power cable

Accessories

Description	Item no.	Page	Picture
Mounting bracket with snap-in mechanism for fixation of the divider housing. The UV resistant clips can be closed by hand without any tool.	85140742	140	
Clamps for hybrid cable	depends on cable diameter	136	
Grounding kits	85015070	138	
Grounding cable, 0.5 m, 16 mm ² and 25 mm ² , black and yellow/green	depends on cross section and colour	139	
Quick hose clamps Stainless steel One set includes 2 pieces hose clamps	clamping Ø 30 to 155 mm	140	
	clamping Ø 60 to 500 mm		



MASTERLINE Classic (MLC)



Multi-riser cable with distribution box

MASTERLINE Classic uses separate multifiber and multi-conductor copper riser cables that are connected to mast mounted FTTA/PTTA distribution boxes which are then linked to the RRHs with short jumper cables. Traditionally multi-riser cables with distribution boxes have been the preferred solution for multi-RRH installations, however with the increasing number of remote radios per site mast space limitations and wind loading have become critical issues to operators.

Moreover some operators can incur extra leasing costs for every box placed on the mast, thus distribution box based systems are gradually being superseded by box-less solutions like MASTERLINE Extreme (see page 44). In general, the installation method with boxes is cost effective and offers installation flexibility but it does require handling and connecting of indoor LC connectors at the mast-top distribution box. Many operators want to avoid the risk of opening and maintaining mast-top boxes by non-trained or non-authorized persons.

MASTERLINE Classic (MLC)

RF LISCA RF jumper
page 162



FTTA LC duplex RRH jumpers
page 66



PTTA 2-core power cable
page 68



FTTA FTTA distribution box
page 62



PTTA PTTA distribution box
page 69



FTTA MASTERLINE Classic
page 60



PTTA Multicore power cable
page 68



XTTA Cable clamps
page 134



FTTA CTB 19" patching box (optional)
page 130



FTTA LC patchcord
page 133

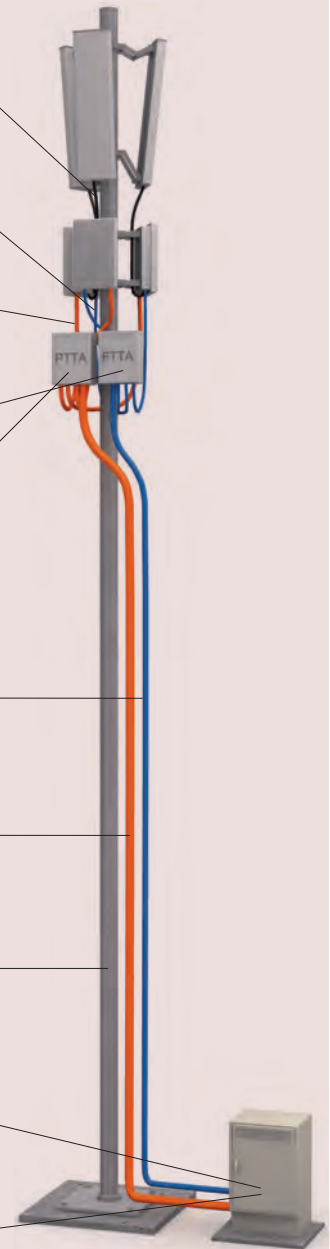
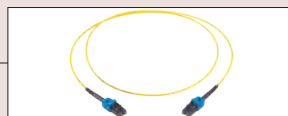

XTTA FTTA, PTTA and HTTA

PTTA Power-To-The-Antenna

RF Radio Frequency

HTTA Hybrid-To-The-Antenna

FTTA Fiber-To-The-Antenna

MASTERLINE Classic (MLC)



Features





- Ruggedised outdoor fiber distribution box
- Supports up to 24 remote radio heads
- Fitted with bend radius limiting mandrels
- Suitable for mounting on poles, walls and tower legs with round-, L-, V- and □-shape.
- Easy to mount and install with pre-mounted brackets
- Compatible with MASTERLINE Classic
- Fully electrically isolated
- Protective vent equalises pressure and prevents water condensation

Specifications

Number of RRH	up to 6 RRH (12 fibers)	up to 12 RRH (24 fibers) up to 18 RRH (36 fibers)	up to 24 RRH (48 fibers)
Dimensions	255 × 180 × 65 mm	240 × 240 × 132 mm	250 × 320 × 138 mm
Cable entry	1 × MLC 12 fibers (Ø 16 mm)	2 × MLC 12 fibers (Ø 16 mm) 1 × MLC 24 fibers (Ø 26 mm)	2 × MLC 12 fibers (Ø 16 mm) 1 × MLC 48 fibers (Ø 26 mm)
Cable exit (pre-installed cable gland)	up to 6 jumper cable 1 × M32 cable gland with 6-fold seal for jumper cables with Ø 4.7 to 5.6 mm	up to 18 jumper cable 3 × M32 cable gland with 6-fold seal for jumper cable with Ø 4.7 to 5.6 mm	up to 24 jumper cable 4 × M32 cable gland with 6-fold seal for jumper cable with Ø 4.7 to 5.6 mm
Material	glass-filled polycarbonate, halogen-free, UV resistant		
Colour	grey RAL 7035		
Flammability rating	UL 94 V0		
Operating temperature	during inst.	-10 to +50 °C	
	in service	-40 to +75 °C	
Protective vent	typical airflow 2500 ml/min		
Ingress protection	IP66/67		
Impact resistance	IK 07 (EN 62262)		







MASTERLINE Classic (MLC)

FTTA distribution box – ordering information

Description	Item no. single-mode	Item no. multimode OM3	Picture
FTTA box small Compatible with MASTERLINE Classic 12 fibers Cable glands for up to 6 jumper 6 LC duplex adapter (blue/aqua)	85165306	85174583	
FTTA box medium Compatible with MASTERLINE Classic 12/24 fibers Cable glands for up to 12 jumper 12 LC duplex adapter (blue/aqua)	85174585	85174629	
FTTA box medium Compatible with MASTERLINE Classic 12/24/36 fibers Cable glands for up to 18 jumper 18 LC duplex adapter (blue/aqua)	85174587	85174630	
FTTA box large Compatible with MASTERLINE Classic 12/24/36/48 fibers Cable glands for up to 24 jumper 24 LC duplex adapter (blue/aqua)	85174588	85174631	

All boxes are pre-assembled with fiber management components, cable glands and quick-hose clamps.

Accessories – ordering information

Description	Item no.	Page	Picture	
For outdoor and indoor installation, stores up to 20 m cable excess, length (depending on cable diameter)	84103325	127		
Combined clamps for fiber optic and power cable	depends on cable diameter	134		
19" CTB patching box	6, 12, 18 or 24 LC duplex adapter	depends on quantity of LC adapter	130	
LC patchcords	0.5 m, 0.7 m or 1 m length, single-mode	depends on length	133	
Quick hose clamps Stainless steel One set includes 2 pieces hose clamps	clamping Ø 30 to 155 mm	84076411	140	
	clamping Ø 60 to 500 mm	84076412		
SFP/SFP+ transceivers for different protocols, data rates and power budgets.	see transceiver selection guide on page 260	259		

MASTERLINE Classic (MLC)



Features

- Pre-assembled „plug & play“ cabling system
- Ruggedised design with robust pulling tube
- Outdoor and indoor with high flame resistance
- Temperature range -40 up to +75 °C
- Ingress protection IP67 when installed
- Loose tube cables with up to 48 fibers, rodent protected and UV resistant and CPR compliant
- Both sides terminated with LC uniboot connectors
- Breakouts numbered for easy channel identification
- Easy and time-saving installation
- Each system factory tested

Specifications

		MLC 12 fiber	MLC 24 fiber	MLC 36 fiber	MLC 48 fiber
Number of fibers		12	24	36	48
Number of LC-HQ duplex uniboot connectors each side		6	12	18	24
Build-in hole dimension	FTTA box side	15.6 to 16.4 mm	25.5 to 26.5 mm	25.5 to 26.5 mm	25.5 to 26.5 mm
	BTS side	15.6 to 16.4 mm	15.6 to 16.4 mm	25.5 to 26.5 mm	25.5 to 26.5 mm
Cable type		Glass-armoured multifiber loose tube cable			
Jacket material		LSFH™, black			
Cable diameter		7.0 mm		9.6 mm	
Minimum bending radius	during installation	110 mm		140 mm	
	in service	70 mm		100 mm	
Temperature range	during installation	-10 to +50 °C			
	in service	-40 to 75 °C			
Ingress protection		IP67, when installed with FTTA box			
Halogen-free		IEC 60754-1			
Fire propagation		IEC 60332-1 and IEC 60332-3-25			
CPR compliant		class D _{co} s1a, d0, a1			
Pulling tube with pulling eye	outer diameter	36 mm			50 mm
Protection tube BTS side	outer diameter	36 mm			50 mm



Protecting tube at BTS side



Pulling tube with pulling eye at RRH side

MASTERLINE Classic (MLC)

Ordering information



Length	Item no. :					
	12 fibers/6 RRH		24 fibers/12 RRH		36 fibers/18 RRH	48 fibers/24 RRH
	single-mode E9/125 A2	multimode G50/125 OM3	single-mode E9/125 A2	multimode G50/125 OM3	single-mode E9/125 A2	single-mode E9/125 A2
20 m	85012382	85164945	85012383	85142756	85066843	85074331
30 m	85012502	85164946	85012589	85142757	85066962	85074332
40 m	85012503	85164947	85012590	85142758	85066964	85074333
50 m	85012504	85164948	85012592	85142759	85066966	85074334
60 m	85012505	85164949	85012593	85142768	85066979	85074335
70 m	85012506	85164950	85012594	85142769	85066986	85074336
80 m	85012543	85164951	85012595	85142780	85066987	85074337
90 m	85012544	85164952	85012596	85087968	85066988	85074338
100 m	85012545	85164953	85012597	85142781	85066989	85074339
125 m	85012546	85004887	85012598	85142782	85068299	85074340

Option:

- Other length
- Multimode OM4
- UL listed (OFNR)



Up to 80 m supplied as air ring and for longer cable systems on a double-flange reel

MASTERLINE Classic (MLC)



Features

- Jumper available for all types of remote radios
- Cable diameter 4.8 mm, 5.5 mm or 7 mm
- Standard lengths of 2 m and 5 m, any customised length available

Ordering information

LC duplex to ODC plug, jumper cable Ø 5.5 mm



Length	Item no. single-mode E9/125 A1 (G.657.A1)
2 m	84122152
5 m	84078725

LC duplex to LC duplex with moulded divider and ruggedised break-out 98 mm long, cable Ø 4.8 mm cable



Length	Item no. single-mode E9/125 A2 (G.657.A2)
2 m	85031793
5 m	85031794

LC duplex to LC duplex jumper, with metal divider and ruggedised break-out 90 mm long, cable Ø 4.8 mm



Length	Item no. single-mode E9/125 A2 (G.657.A2)
2 m	84142320
5 m	84142321

MASTERLINE Classic (MLC)

LC duplex to FullAXS jumper, cable Ø 4.8 mm



Length	Item no. single-mode E9/125 A2 (G.657.A2)
2 m	84137910
5 m	84137911

LC duplex to LC duplex jumper with ruggedised break-out 85 mm long, cable Ø 5.5 mm



Length	Item no. single-mode E9/125 A2 (G.657.A2)	Item no. multimode G50/125 OM3
2.5 m	84122419	84122420
5 m	84122418	84104136

LC duplex to LC duplex jumper with ruggedised break-out 90 mm long, cable Ø 4.8 mm (Ø 7.0 mm at the RRH pre-chamber entry position), single-mode bend insensitive fiber



Length	Item no. single-mode E9/125 A2 (G.657.A2)	Item no. multimode G50/125 OM3
2 m	85015008	85140777
3 m	85015009	85140778
5 m	85015010	85140780

LC duplex to PDLC, jumper cable Ø 7 mm



Length	Item no. single-mode E9/125 A2 (G.657.A2)
2 m	84150634
5 m	84150635

LC duplex RRH jumper for other OEM interfaces

Please contact HUBER+SUHNER for LC duplex RRH jumper for other OEM interfaces which are not listed above.

Options:

- Other length
- Multimode OM4

Multicore power supply cable

6, 12 and 24 core power supply cable



Features

- Highly flexible power cable with low bending radius
- White and red insulation according IEC 60445:2021
- 6, 12 and 24 core power supply cables with cross section up to 25 mm²
- Aluminum foil shielding and earth conductor for grounding
- CPR compliant class B_{2ca}
- LSFH jacket material

Specifications

Jacket material	Thermoplastic LSFH (low smoke free of halogen)
Insulation material	XLPE
Insulation color	Red and white, IEC 60445:2021
Screen	Aluminum foil with earth conductor copper tinned 6 mm ²
UV-resistant	passed according to EN ISO 4892-2
CPR classification	class B _{2ca} -s1a,d1,a1
Standard	IEC 60502-1
Rated voltage	0.6 / 1.0 kV
Operating temperature range	-40 °C to +90 °C
Installation temperature range	-10 °C to +50 °C
Conductor type IEC 60228	annealed copper class 5

	6 core cable				12 core cable			24 core cable		
Cross section	6 mm ²	10 mm ²	16 mm ²	25 mm ²	6 mm ²	10 mm ²	16 mm ²	6 mm ²	10 mm ²	16 mm ²
Resistance	3.30 Ω/km	1.91 Ω/km	1.21 Ω/km	0.78 Ω/km	3.30 Ω/km	1.91 Ω/km	1.21 Ω/km	3.30 Ω/km	1.91 Ω/km	1.21 Ω/km
Current rating*	31.3 A	42.7 A	57.2 A	74.1 A	26.0 A	35.0 A	46.5 A	20.1 A	27.5 A	36.7 A
Cable diameter	16.7 mm	19.7 mm	22.7 mm	28.1 mm	21.7 mm	25.9 mm	30.3 mm	29.9 mm	36.3 mm	42.7 mm
Weight	0.52 kg/m	0.79 kg/m	1.13 kg/m	1.71 kg/m	0.89 kg/m	1.39 kg/m	2.02 kg/m	1.66 kg/m	2.62 kg/m	3.92 kg/m

Ordering information

Item no.	Cross section	Length per reel	Item no.	Cross section	Length per reel	Item no.	Cross section	Length per reel
85202643	6 x 6 mm ²	1000 m	85202638	12 x 6 mm ²	1000 m	85202582	24 x 6 mm ²	500 m
85202642	6 x 10 mm ²	1000 m	85202627	12 x 10 mm ²	1000 m	85202581	24 x 10 mm ²	250 m
85202646	6 x 16 mm ²	1000 m	85202622	12 x 16 mm ²	1000 m	85202645	24 x 16 mm ²	250 m
85202644	6 x 25 mm ²	500 m						

Multicore power cables are delivered on wooden reel with flange diameter 140 cm or 160 cm

2 core power jumper cable

2 core power cable with aluminium foil shielding, red and white insulation and CPR class B2_{ca}



Features

- Suitable for HUBER+SUHNER's PTTA boxes
- highly flexible power cable with low bending radius and excellent cable routing properties
- Red and white XLPE insulation compliant to IEC60445:2021
- Aluminum foil shielding with tinned copper drain conductor
- CPR compliant class B2_{ca}
- Voltage rating 600 V

Specifications

Jacket material	LSFH
Insulation material	XLPE
Insulation color IEC 60445:2021	red, white
Screen	Aluminum/PET foil with tinned copper drain conductor
Drain wire type IEC 60228	Annealed tinned copper class 5
UV-resistant	According to IEC 60068-2-5
CPR classification	B2 _{ca} -s1,d2,a1
Standard	IEC 60502 / IEC 60092
Rated voltage	0.6/1.0 kV
Temperature range	-40 to 85°C
Conductor type IEC 60228	Annealed copper class 5

Conductor cross section	6 mm ²	10 mm ²
Conductor resistance	3.30 Ω/km	1.91 Ω/km
Maximum current rating at 60 °C ambient temperature	45 A	61 A
Drain wire cross section	4 mm ²	6 mm ²
Cable diameter	11.2 mm	13.4 mm
Weight	0.24 kg/m	0.37 kg/m

Ordering information

Item no.	Cross section	Length per reel	Reel flange size
85173020	6 mm ²	1000 m	100 cm
85173021	10 mm ²	1000 m	110 cm

PTTA distribution box

PTTA distribution box 6 RRH



Features

- Ruggedised outdoor power distribution box
- Supports up to 6 remote radio heads
- Maximum current rating 40 A
- Push-in terminals with front connection to enable wiring in a confined space
- Suitable for mounting on poles, walls and tower legs with round, L, V and □-shape

The Power-to-the-Antenna distribution box 6 RRH is fitted with the latest connection technology - push in terminals - for conductors up to 16 mm² cross section. The push in terminals have front access to allow easy and fast connection. By using cable glands with 6-fold seals, the PTTA box has very small dimensions. The 6-fold seal is tailored to HUBER+SUHNER 2-core non CPR power jumper cables with 4 mm², 6 mm² and 10 mm² conductors. With a maximum current of 40A, the PTTA Box can be used for RRHs with high power consumption.

The opened lid is secured with a wire against falling down. The box is optional available with a hinged cover.

Specifications

Number of RRH	up to 6
Dimension	278 x 188 x 130 mm
Power entry	Cable gland M50 with wrench size 60 mm, 2 seals for Ø 21.0 – 25.5 / Ø 25.5 – 36.0 mm 1 cable 12 core shielded up to 16mm ²
Power exit	Cable gland M60 with wrench size 68 mm, 3 seals for Ø 10.2 - 10.9 / 11.5 – 12.2 / 12.8 – 13.5 mm
Grounding cable	Ø 6.0 – 12 mm
Maximum voltage rating	- 74 Vdc
Maximum current rating per RRH	40 A (with 16 mm ² 12 core power cable)
Terminals	Push-in type up to 16 mm ²
Temperature range during installation	-10 to +40 °C
Temperature range during service	-40 to +75 °C
Box material	Polycarbonat, light grey (RAL 7035), halogen free
UV resistance	according UL 508
Ingress protection	IP 65 EN 60529
Impact resistance	IK 08 EN 62262

Ordering information

Description	Item no.
PTTA distribution box 6 RRH for an installation with a 12 core power cable up to 16 mm ² and 6 power jumper cables 4 to 10 mm ² , push-in terminals, quick hose clamps for pole diameter 30 to 155 mm are included	85145915

Customized PTTA (Power-To-The-Antenna) boxes

In addition to pure power distribution from multi-core copper cables to 2-core power jumper cables, HUBER+SUHNER offers customised configurations with circuit breakers and surge protection devices. The DC circuit breakers with hydraulic-magnetic technology have a rating capability that is independent of the ambient temperature, which is a great advantage when used on outdoor installations. The circuit breakers are available with 20A, 25A, 32A or 40A current rating. Surge protection device type 1/2 (class I/II) for grounded return installation are used for lightning protection or optional a lightning current arrester, in accordance with type 1 (class I) with impulse discharge current (10/350) µs 25 kA / 100 kA.



PTTA distribution box

PTTA distribution box 12 RRH



Features

- Ruggedised outdoor power distribution box
- Supports up to 12 remote radio heads
- Maximum current rating 36 A
- Push-in terminals with front connection to enable wiring in a confined space
- Suitable for mounting on poles, walls and tower legs with round, L, V and □-shape

Specifications

Number of RRH	up to 12
Dimension	378 x 188 x 130 mm
Power entry	Cable gland M63 with wrench size 73 mm, 3 seals for Ø 31.0 – 35.0 / Ø 35.0 – 41.0 / Ø 41.0 – 47.0 mm 1 cable 24 core shielded up to 16 mm ²
Power exit	2 cable gland M60 with wrench size 68 mm, 3 seals for Ø 10.2 - 10.9 / 11.5 – 12.2 / 12.8 – 13.5 mm up to 12 cables 2-core shielded up to 10mm ²
Grounding cable	Ø 6.0 – 12 mm
Maximum voltage rating	- 74 Vdc
Maximum current rating per RRH	36 A (with 16 mm ² 24 core power cable)
Terminals	Push-in type up to 16 mm ²
Temperature range during installation	-10 to +40 °C
Temperature range during service	-40 to +75 °C
Box material	Polycarbonat, light grey (RAL 7035), halogen free
UV resistance	according UL 508
Ingress protection	IP 65 EN 60529
Impact resistance	IK 08 EN 62262

Ordering information

Description	Item no.
PTTA distribution box 12 RRH for an installation with a 24 core power cable up to 16 mm ² and 6 power jumper cables 4 to 10 mm ² , push-in terminals, quick hose clamps for pole diameter 30 to 155 mm are included	85145921

PTTA distribution box

Cable gland tools



Features

- hexagonal steel tube with a handle
- suitable for large cable glands with wrench size 60 to 85mm

To tighten the cable glands use the hexagonal tube with a handle. You will then torque to completion using the torque spanner to finish up the job for the best results. For the correct torque value please refer to the installation manual.



Specifications

Material wrench	Cr12 alloy tool steel
Material hand shank	Stainless steel

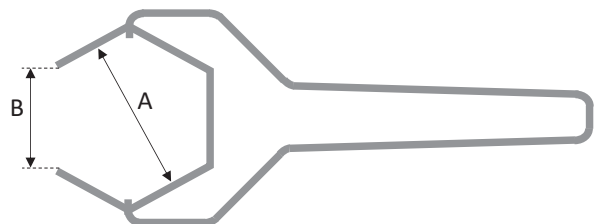
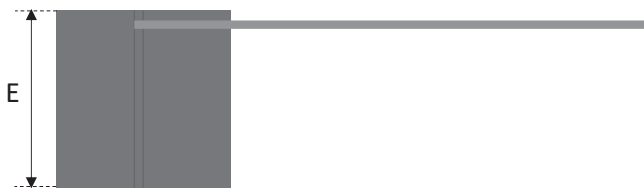

Ordering information

Item number	Wrench size	Dimensions A / B / E	
85162588	60 mm	60.5 / 37.4 / 100 mm	
85162589	68 mm	68.5 / 41.8 / 100 mm	
85162590	73 mm	73.5 / 44.0 / 100 mm	
85162591	80 mm	80.5 / 49.0 / 100 mm	
85162725	60 mm	60.5 / 37.4 / 20 mm	
85162669	75 mm	75.5 / 46.0 / 20 mm	
85162669	85 mm	85.5 / 51.0 / 20 mm	



MASTERLINE Ultimate Hybrid High Voltage (MLUH HV)

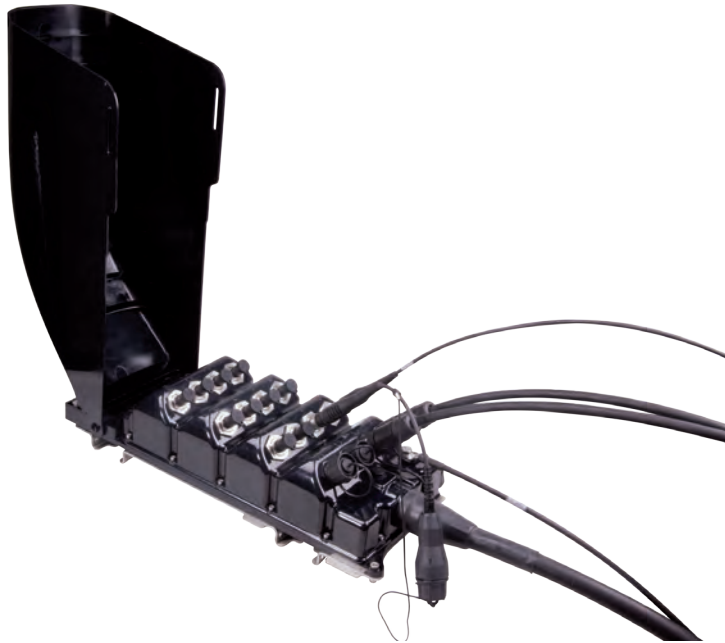

Hybrid-riser cable with compact connector head high voltage CE conformity

The most innovative hybrid cabling system of HUBER+SÜHNER for remote radio installation became even more innovative by offering capability to deliver 230 VAC up the mast, allowing much longer cabling with significant cost savings on cables and more efficient power transfer. The pre-connectorised factory-sealed hybrid systems supports up to 12 RRHs and connects the remote radios with easy-to-install Q-ODC fiber optic and power jumpers. The encapsulated connector head can be directly attached to the mast with a single „click“ at a pre-mounted adaptor plate. These unique features make MASTERLINE Ultimate Hybrid High Voltage the only in-class product offering all the advantages of the MASTERLINE Ultimate family together with high voltage conformity confirmed by the worldwide recognised CE marking. For extra safety the whole head is protected by removable cover.

MASTERLINE Ultimate Hybrid High Voltage (MLUH HV)

RF

LISCA RF jumper
page 162



FTTA

Q-ODC RRH jumper
page 30



PTTA

Alternative power jumper
page 43



HTTA

MLUH HV with Q-ODC-2
page 90



XTTA

Cable clamps
page 134



FTTA

CTB 19" patching box (optional)
page 130



FTTA

LC patchcord (optional)
page 133

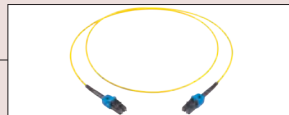

XTTA FTTA, PTTA and HTTA

RF Radio Frequency

FTTA Fiber-To-The-Antenna

PTTA Power-To-The-Antenna

HTTA Hybrid-To-The-Antenna

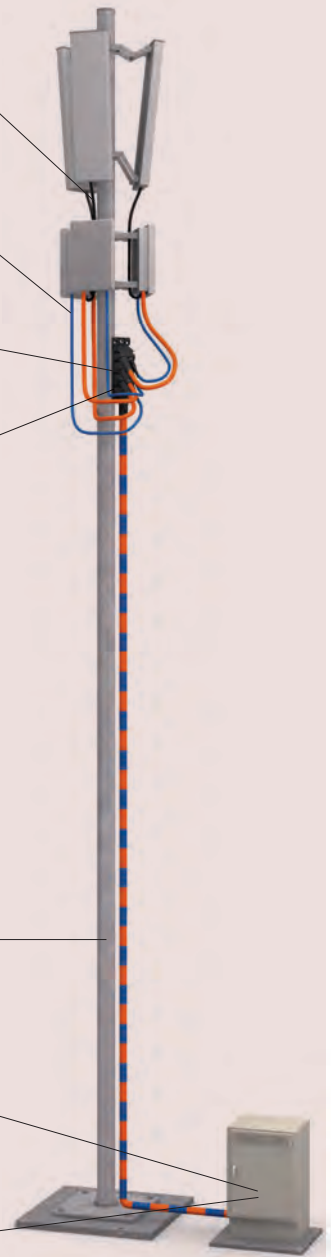

MASTERLINE Ultimate Hybrid High Voltage (MLUH HV)

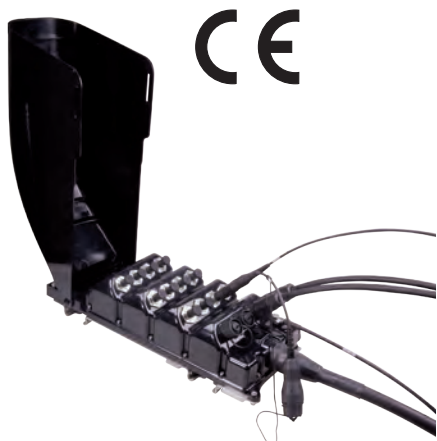

Features

- Pre-connectorised factory-sealed hybrid cable system for 12 RRHs
- Modular „plug & play“ system compatible with Q-ODC/Q-ODC-12 and power jumpers
- Encapsulated IP67 sealed connector head housing
- Hoisting grip for cable lifting
- Space-efficient, low wind-load
- Mounting bracket for easy mast-, pole-, and wall-installation
- Integral earth point which can be connected to an earth lead with M8 ring terminal
- Equipped with protection cover for cable exits as a standard
- CE conformity for 230 VAC (higher voltages on request)

Specifications

Number of rugged circular power sockets	4	
Number of Q-ODC-2 sockets	12 (2 fibers per socket)	
Dimensions L x W x H	515 x 195 x 234 mm	
Dimensions without cover L x W x H	515 x 195 x 110 mm	
Rated current (IEC 60364-5-52, method E)	40 A (4 x 10A)	
Rated voltage	230 VAC	
Ambient temperature range	in service	-40 to +75 °C
	installation	-10 to +50 °C
Ingress protection (IEC 60300)	IP65/IP67	
Impact resistance (IEC 60300)	IK 10	
Halogen-free IEC (60754-2)	yes	
UV resistant for outdoor use	ISO 4892-3 (1000h)	
Material flammability rating	UL94-V0	
Housing material	high-performance polycarbonate	



MASTERLINE Classic at BTS side



Supplied on a double-flange reel



Integral earth connection

MASTERLINE Ultimate Hybrid High Voltage (MLUH HV)

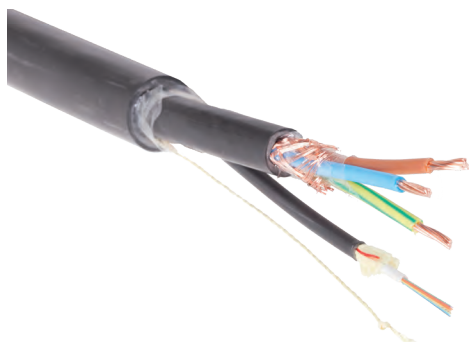

Hybrid cables of HUBER+SÜHNER combine optical fiber and AC power, are highly flexible, easy-to-route and offer substantial costs savings due to lower number of copper conductors. The rip cord between the shielding and the jacket allows a quick stripping of the jacket. The power cable consist of three conductors extra shielded by the braided copper shield.

Hybrid cable consisting of a shielded power cable with 3 conductors (L, N, PE) and a fiber optic cable with 24 fibers

Specifications

Jacket material		thermoplastic, low smoke, free of halogen
Standard		IEC 60502-1:2004-04
Temperature range	in service	-40 to +75 °C
	installation	-10 to +50 °C
Operating voltage		230 VAC
Rated voltage		0.6 kV/1 kV (1.2 kV)
Min. bending radius	during installation	10 × cable-Ø
	in service	8 × cable-Ø
Conductors		4 mm ²
Fiber optic		non-armoured multifiber loose tube jelly-filled
Halogen-free		yes
Flame retardant		IEC 60332-1-2:2004.
UV resistant		IEC 60068-2-5
CE conform		yes
CPR compliant		yes, class D _{ca}

Ask your local sales contact for further information or find more information at <http://literature.hubersuhner.com/Technologies/Fiberoptics/LowInductanceWhitepaper/>.

MASTERLINE Ultimate Hybrid High Voltage (MLUH HV)

Power connectors



Power connector plug at the jumper



Power connector flange socket at the MLUH connector head

Features

- Rugged circular plastic plug connector for remote radio installations
- Machined crimp contacts Ø 3.6 mm for high current
- Bayonet coupling system for easy and quick mating
- 3 wire shielded copper cable with 1.5 mm² cross section

The bayonet coupling system enables a simple and fast mating. With only a 1/3 twist of the coupling ring, connectors are mated with an audible and tactile „click“. The machined 3.6 mm crimp contacts ensure a vibration safe termination and a high current rating. Specifications see page 41 (MLUP).

Mating/unmating sequences



Twist the coupling ring of the plug connector to remove protecting cap as shown.



Align white strip on the plug with the white strip on the socket to find keying position easier. Make sure the plug connector is in-line with the socket connector before coupling ring is twisted.

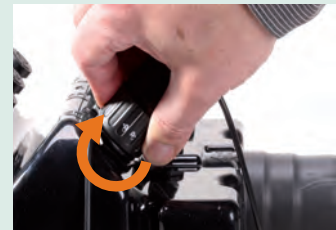

Twist coupling ring as shown to mate or unmate the plug connector.

Q-ODC connectors



Q-ODC plug on the jumper



Q-ODC socket on MLUH HV

Features

- Robust push-pull coupling mechanism – two clearly defined mating states
- Highest outdoor installation safety
- Waterproof, dust proof and corrosion resistant; does not require secondary wrapping

Specification see page 145 (Fiber optic interfaces).

Mating/unmating sequences

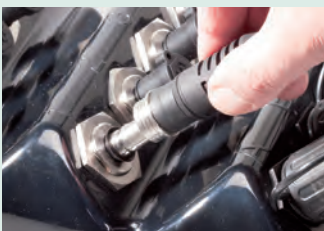

Push plug connector slightly into socket connector, rotate to find keying position, push connector to mate.

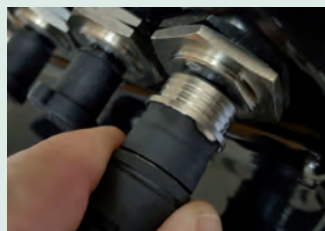

Mated - connector snaps in and is fully strain relieved.



Pull coupling ring to unmate.

MLUH HV installation

Easiest-to-install hybrid product available on the market.

Installation features

	<p>Installation video and manual With a smartphone the QR code attached to the spool can be scanned and it takes you directly to the relevant internet site where the installation manual or installation video can be chosen.</p>
	<p>MLUH HV mounting bracket The MLUH HV mounting bracket is fixed to the mast or wall before the MLUH HV is lifted.</p>
	<p>Unspooling The MLUH HV is supplied on a double-flange reel which allows for easy and straight-forward unspooling while lifting the cable up the mast.</p>
	<p>Pulling With a pre-laced hosting grip below the MLUH connector head, the cable system is lifted up to the mast.</p>
	<p>Hook-in MLUH HV head at mounting bracket After the protection air bubble bag is removed, the MLUH HV connector head can be hooked-in to the mounting bracket.</p>
	<p>RRH connection The remote radios are connected with fiber optic jumpers, which are terminated with Q-ODC/ Q-ODC-12 plug connectors and RRH compatible interfaces. The power jumpers are terminated with a rugged circular plastic plug connector and are blunt cut on the RRH side.</p>
	<p>Earthing The MLUH HV head has an integral earth point which can be connected to an earth lead with M8 ring terminal. Optional, the shielding of the hybrid cable can be grounded with standard grounding kits.</p>
	<p>Base station connection The pre-terminated LC fiber optic connectors are protected with a IP65 protection tube. Once the protection tube is screwed-off, the installer has access to the fiber optic breakout cables and the individual copper/ground wires.</p>
	<p>Overlength management The hybrid cable has 1 rip cord below the jacket to allow easy stripping of the jacket over a distance of several meters. This allows the installer to cut the excess length of the copper wire while the overlength of the pre-terminated fiber cable is stored inside the base station or in a overlength box.</p>

MASTERLINE Ultimate Hybrid High Voltage (MLUH HV) with Q-ODC

Ordering information

MASTERLINE Ultimate Hybrid for 12 RRHs - MLUH HV 4/12



	Radio end side	BTS side
Fiber optic	12 Q-ODC sockets	12 uniboost
Power	3 conductors (phase, zero, grounding) blunt cut	3 conductors (phase, zero, grounding) blunt cut wire cross section 4 mm ²

Hybrid cable	Fiber optic	Market	Jacket material	Wire cross section Cable diameter Cable weight	Length	Item no.
3 pairs conductors	12 pairs single-mode	global CPR compliant	LSFH™	4 mm ² 22 mm (5/8") 0.57 kg/m	10 m	85105314
					20 m	85098600
					30 m	85105315
					40 m	85105316
					50 m	85105318
					60 m	85105319
					70 m	85105320
					80 m	85105321
					90 m	85105322
					100 m	85105323

Option

- Multimode fiber
- Other length

MASTERLINE Ultimate Hybrid High Voltage (MLUH HV) with Q-ODC

Q-ODC RRH jumpers



Features

- Compatible with MLE, MLEH, MLU and MLUH terminated with Q-ODC
- Ruggedised and robust RRH jumper cable – easy and reliable to install
- Available for all types of RRH
- Cable diameter 4.8 mm, 5.5 mm or 7 mm
- Standard lengths of 2, 5 and 10 m, customised lengths available

Jumpers for all types of remote radio systems available. Ordering information see page 30 (MLU).

Power jumpers



Features

- Compatible with MLUH HV
- Terminated with a rugged circular plastic plug connector and blunt cut on the RRH side
- 3 copper conductor 1.5 mm² with braided copper shielding for 230 VAC power supply
- Standard length 2, 5 and 10 m

Ordering information see below.

Specifications

Jacket material	LSFH™
Conductor type	copper stranded, IEC 60228 class 2
Insulation colour	blue, brown, yellow/green (grounding)
Cable shielding	braided screen of copper wires, coverage 65 to 85 %
Rated voltage	0.6/1.0 kV
Conductor cross section	3 × 1.5 mm ²
Resistance	12.1 Ω/km
Current per conductor	10 A
Cable diameter	11 mm
Cross section braid	3.1 mm ²









Ordering information

Market	Length	Item no.
Global Not UL listed	2 m	85099139
	5 m	85099140
	10 m	85099141

MASTERLINE Ultimate Hybrid High Voltage (MLUH HV)

Accessories

Description		Item no.	Page	Picture
Overlength box for outdoor and indoor installation, stores up to 20 m cable excess length (depending on cable diameter)		84103325	127	
Clamps for hybrid cable		depends on cable diameter	134	
Grounding cable, 0.5 m, 16 mm ² and 25 mm ² , black and yellow/green		depends on cross section and colour	139	
19" CTB patching box	6, 12, 18 or 24 LC duplex adapter blue	depends on quantity of LC adapter	130	
LC patchcords	0.5 m, 0.7 m or 1 m length, single-mode	depends on length	133	
Quick hose clamps Stainless steel One set includes 2 pieces hose clamps	clamping Ø 30 to 155 mm	84076411	140	
	clamping Ø 60 to 500 mm	84076412		
SFP/SFP+ transceivers for different protocols, data rates and power budgets.		see transceiver selection guide on page 260	259	



MASTERLINE Ultimate Hybrid (MLUH)



Hybrid-riser cable with compact connector head

The most innovative hybrid cabling system from HUBER+SÜHNER for remote radio installation: MASTERLINE Ultimate Hybrid. The pre-connectorised factory-sealed hybrid systems supports up to 6 RRHs and connects the remote radios with easy-to-install Q-ODC fiber optic and power jumpers. A pre-laced hosting grip below the robust connector head allow for easy cable lifting. The encapsulated connector head can be directly attached to the mast at a pre-mounted bracket. These unique features make MASTERLINE Ultimate Hybrid the best-in-class product in terms of ease of mast-top installation, installation robustness and efficiency.

MASTERLINE Ultimate Hybrid (MLUH)

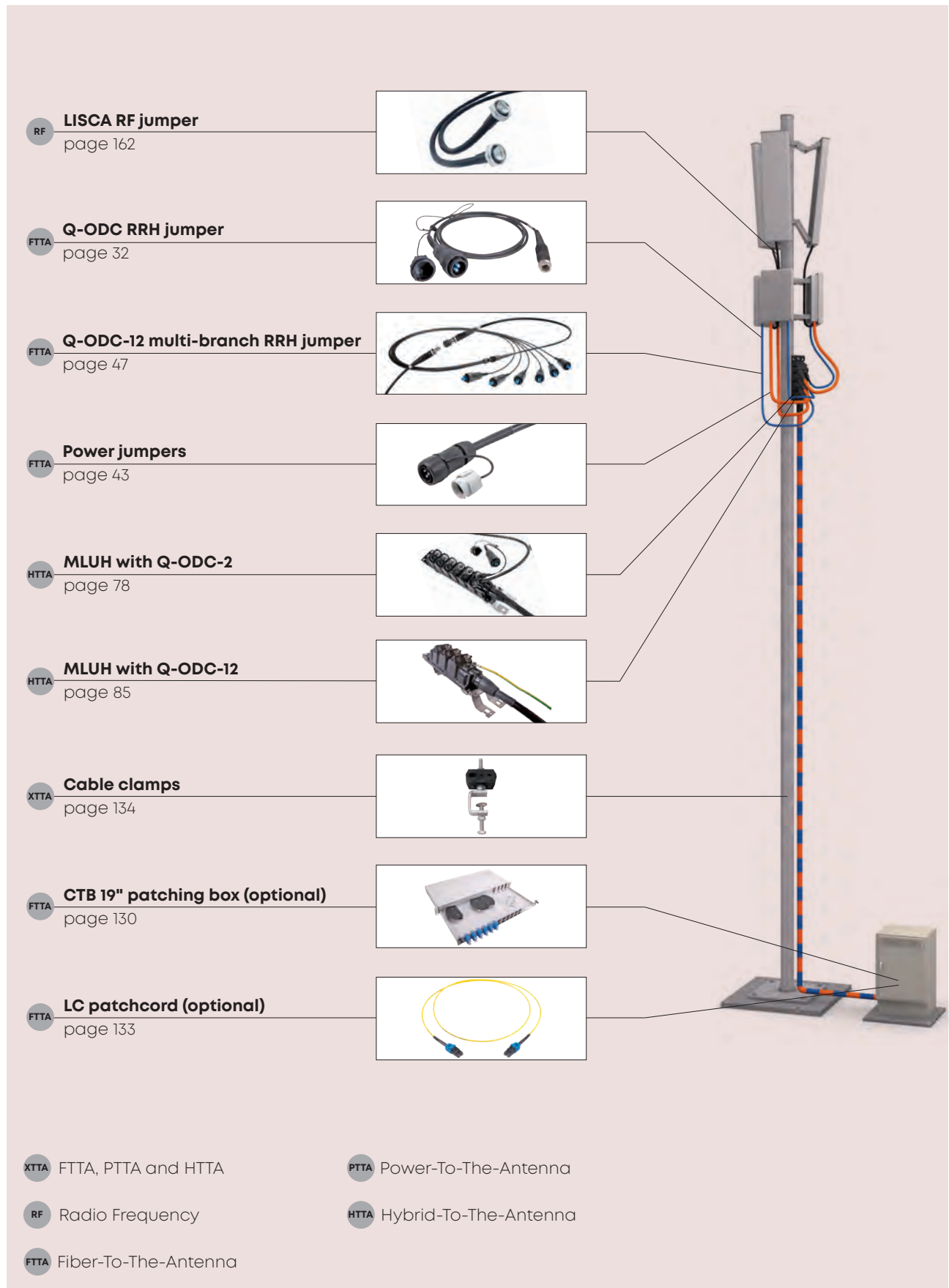

MASTERLINE Ultimate Hybrid (MLUH)



Features

- Pre-connectorised factory-sealed hybrid cable system for 3 and 6 RRHs
- Modular „plug & play“ system compatible with Q-ODC/Q-ODC-12 and power jumpers
- Highly flexible 6-/12-core hybrid cable up to 16 mm²/AWG 6
- Encapsulated IP67 sealed connector head housing
- Hoisting grip for cable lifting
- Space-efficient, low wind-load
- Mounting bracket for easy mast-, pole-, and wall-installation
- Integral earth point which can be connected to an earth lead with M8 ring terminal
- Optional protection cover for cable exits available

Specifications

	Small	Large
Number of rugged circular power sockets	3	6
Number of Q-ODC-2 sockets	3 (2 fibers per socket)	6 (2 fibers per socket)
Dimensions L x W x H	310 x 90 x 97 mm	477 x 90 x 97 mm
Housing material	high-performance polycarbonate	
UV resistance, ISO 4892-3 (methode A/cycle 1)	1000 h	
Maximum current rating	up to 42A per power socket (depending on the hybrid cable)	
Ambient temperature range	in service	-40 to +75 °C
	installation	-10 to +50 °C
Ingress protection (IEC 60529)	IP67	
Impact resistance (IEC 62262)	IK 10	
Material flammability rating	UL94-V0	



MASTERLINE Classic at BTS side



Supplied on a double-flange reel



Integral earth connection

MASTERLINE Ultimate Hybrid (MLUH)

Hybrid cable general specifications

	LSFH™ hybrid cable, global market	UL listed hybrid cable, US market
Jacket material	thermoplastic, LSFH™	PVC
Standard	IEC 60502-1:2004-04	UL 1277, TC-OF-ER
Rated voltage	0.6 kV/1 kV (1.2 kV)	
Min. bending	during installation	10 × cable Ø
	in service	8 × cable Ø
Cable shielding	copper foil 100 % coverage (contacted with drain wire)	
Conductor type	IEC 60228 class 5	class C THHN/THWN-2
Halogen-free	yes	no
Flame retardant	IEC 60332-1-2:2004	UL 1685 (UL 1581) vertical tray flame test
CPR compliant	yes, class Dca	no

Hybrid cable specification MLUH 3/3

	LSFH™ hybrid cable, global market			UL listed hybrid cable, US market		
	6 mm ²	10 mm ²	16 mm ²	AWG 10	AWG 8	AWG 6
Conductor cross section	6 mm ²	10 mm ²	16 mm ²	AWG 10	AWG 8	AWG 6
Resistance	3.08 Ω/km	1.83 Ω/km	1.21 Ω/km	3.41 Ω/km	2.13 Ω/km	1.30 Ω/km
Maximum current rating	31 A	42 A *	42 A *	26 A	36 A	44 A *
Outer diameter	22 mm	22 mm	27.5 mm	19.6 mm (0.77")	23.4 mm (0.92")	23.9 mm (0.945")
Weight	0.73 kg/m	0.96 kg/m	1.36 kg/m	0.69 kg/m	1.05 kg/m	1.4 kg/m
Drain wire cross section	6 mm ²	10 mm ²	10 mm ²	AWG 6	AWG 6	AWG 6
Fiber optic	5 mm loose tube cable with 6 fibers single-mode E9/125 A2 or multimode OM3					

Hybrid cable specification MLUH 6/6

	LSFH™ hybrid cable, global market			UL listed hybrid cable, US market		
	6 mm ²	10 mm ²	16 mm ²	AWG 10	AWG 8	AWG 6
Conductor cross section	6 mm ²	10 mm ²	16 mm ²	AWG 10	AWG 8	AWG 6
Resistance	3.08 Ω/km	1.83 Ω/km	1.21 Ω/km	3.41 Ω/km	2.13 Ω/km	1.30 Ω/km
Maximum current rating	26 A	35 A	42 A *	16 A	23 A	31 A
Outer diameter	27.5 mm	28 mm	36 mm	25.4 mm (1.00")	30.0 mm (1.18")	33.0 mm (1.28")
Weight	1.17 kg/m	1.72 kg/m	2.46 kg/m	1.25 kg/m	1.64 kg/m	2.28 kg/m
Drain wire cross section	6 mm ²	10 mm ²	10 mm ²	AWG 6	AWG 6	AWG 6
Fiber optic	5 mm loose tube cable with 6 fibers single-mode E9/125 A2 or multimode OM3					

* limitation trough power connector maximum current rating 42 A (IEC) and 44 A (UL)

Hybrid cable with 6 pairs power wire and 6 pairs of fiber optic

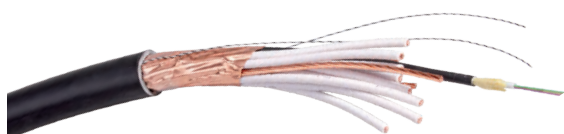

Hybrid cables of HUBER+SUHNER combine optical fiber and DC power, are highly flexible and easy-to-route. Two rip cords between the shielding and the jacket allows a quick stripping of the jacket. The shielding, a copper foil under the jacket and the drain wire maintain contact throughout the cable run and allow potential equalisation and a safe installation with regard to lightning strikes.

MASTERLINE Ultimate Hybrid (MLUH)

Power connectors



Power connector plug at the jumper



Power connector flange socket at the MLUH connector head

Features

- Rugged circular plastic plug connector for remote radio installations
- Machined crimp contacts \varnothing 3.6 mm for high current
- Bayonet coupling system for easy and quick mating
- 2 wire shielded copper cable with cross section of 4 or 6 mm²

The bayonet coupling system enables a simple and fast mating. With only a 1/3 twist of the coupling ring, connectors are mated with an audible and tactile „click“. The machined 3.6 mm crimp contacts ensure a vibration safe termination and a high current rating. Specifications see page 41 (MLUP).

Mating/un-mating sequences



Twist the coupling ring of the plug connector to remove protecting cap as shown.



Push plug connector slightly into flange connector, rotate to find keying position, twist coupling ring of the plug connector as shown.



Twist coupling ring as shown to un-mate the plug connector.

Q-ODC connectors



Q-ODC plug on the jumper



Q-ODC socket on MLUH head

Features

- Robust push-pull coupling mechanism – two clearly defined mating states
- Highest outdoor installation safety
- Waterproof, dust proof and corrosion resistant; does not require secondary wrapping

Mating/un-mating sequences



Push plug connector slightly into socket connector, rotate to find keying position, push connector to mate.



Mated - connector snaps in and is fully strain relieved.



Pull coupling ring to un-mate.

MLUH installation

Easiest-to-install hybrid product available on the market.

Installation features

	<p>Installation video and manual With a smartphone the QR code attached to the spool can be scanned and it takes you directly to the relevant internet site where the installation manual or installation video can be chosen.</p>
	<p>MLUH mounting bracket The MLUH mounting bracket is fixed to the mast or wall before the MLUH is lifted.</p>
	<p>Unspooling The MLUH is supplied on a double-flange reel which allows for easy and straight-forward unspooling while lifting the cable up the mast.</p>
	<p>Pulling With a pre-laced hosting grip below the MLUH connector head, the cable system is lifted up to the mast.</p>
	<p>Hook-in MLUH head at mounting bracket After the protection air bubble bag is removed, the MLUH connector head can be hooked-in to the mounting bracket.</p>
	<p>RRH connection The remote radios are connected with fiber optic jumpers, which are terminated with Q-ODC/ Q-ODC-12 plug connectors and RRH compatible interfaces. The power jumpers are terminated with a rugged circular plastic plug connector and are blunt cut on the RRH side.</p>
	<p>Earthing The MLUH head has an integral earth point which can be connected to an earth lead with M8 ring terminal. Optional, the shielding of the hybrid cable can be grounded with standard grounding kits.</p>
	<p>Base station connection The pre-terminated LC fiber optic connectors are protected with a IP65 protection tube. Once the protection tube is screwed-off, the installer has access to the fiber optic breakout cables and the individual copper/ground wires.</p>
	<p>Overlength management The hybrid cable has 2 rip cords below the jacket to allow easy stripping of the jacket over a distance of several meters. This allows the installer to cut the excess length of the copper wire while the overlength of the pre-terminated fiber cable is stored inside the base station or in a overlength box.</p>

MASTERLINE Ultimate Hybrid (MLUH) with Q-ODC-2

Ordering information

MASTERLINE Ultimate Hybrid for 3 RRHs – MLUH 3/3



	Radio end side	BTS side
Fiber optic	3 Q-ODC sockets	3 LC uniboot
Power	3 rugged circular plastic sockets	3 pairs of wire blunt cut wire, cross section 6 mm ² , 10 mm ² , 16 mm ² , AWG 10, AWG 8, AWG 6

Hybrid cable	Market	Length	Item no.			
			6 mm ²	10 mm ²	16 mm ²	
3 pairs conductor 3 pairs fiber optic single-mode A9/125 A2	global CPR compliant	10 m	85098348			
		20 m	85098349			
		30 m	85098350			
		40 m	85098351			
		50 m	85098352	85136269	85107819	
		60 m		85098353	85107815	
		70 m		85098354	85107812	
		80 m		85098355	85107810	
		90 m		85098356	85107807	
		100 m		85098357	85107805	
	US UL listed			AWG 10	AWG 8	AWG 6
		10 m	85098360			
		20 m	85098361			
		30 m	85098362			
		40 m	85098363			
		50 m	85098364			
		60 m		85098365		
		70 m		85098366		
		80 m		85098367		
		90 m		85098368	85136271	
100 m		85098369	85136272			

Option:

- Multimode OM3
- Other length

MASTERLINE Ultimate Hybrid (MLUH) with Q-ODC-2

Ordering information

MASTERLINE Ultimate Hybrid for 6 RRHs – MLUH 6/6



	Radio end side	BTS side
Fiber optic	6 Q-ODC sockets	6 LC uniboot
Power	6 rugged circular plastic sockets	6 pairs of wire blunt cut wire, cross section 6 mm ² , 10 mm ² , 16 mm ² , AWG 10, AWG 8, AWG 6

Hybrid cable	Market	Length	Item no.			
			6 mm ²	10 mm ²	16 mm ²	
6 pairs conductor 6 pairs fiber optic single-mode A9/125 A2	global CPR compliant		6 mm²	10 mm²	16 mm²	
		10 m	85098374			
		20 m	85098375			
		30 m	85098376			
		40 m	85098377			
		50 m	85098378			
		60 m		85098379		
		70 m		85098380		
		80 m		85098381	85127886	
		90 m		85098382	85127887	
	100 m		85098383	85127888		
	US UL listed			AWG 10	AWG 8	AWG 6
		10 m	85098384			
		20 m	85098385			
		30 m	85098386			
		40 m	85098387			
		50 m	85098388	85136282		
		60 m		85098390		
		70 m		85098391		
		80 m		85098392		
90 m			85098393	85136283		
100 m		85098394	85136284			

Option:

- Multimode OM3
- Other length

MASTERLINE Ultimate Hybrid (MLUH) with Q-ODC-2

Q-ODC RRH jumpers



Features

- Compatible with MLE, MLEH, MLU and MLUH terminated with Q-ODC
- Ruggedised and robust RRH jumper cable – easy and reliable to install
- Available for all types of RRH
- Cable diameter 4.8 mm, 5.5 mm or 7 mm
- Standard lengths of 2, 5 and 10 m, customised lengths available

Jumpers for all types of remote radio systems available.
Ordering information see page 30 (MLU).

Power jumpers



Features

- Compatible with MLUP, MLEP, MLEH and MLUH
- Terminated with a rugged circular plastic plug connector and blunt cut on the RRH side
- 2 wire shielded copper cable with a cross section of 4 mm² to 10 mm² and AWG 12 to AWG 8
- Standard length 2, 5 and 10 m

Ordering information see page 43 (MLUP).

MASTERLINE Ultimate Hybrid (MLUH) is the most innovative hybrid cabling system of HUBER+SUHNER for remote radio installation.

The pre-connectorised factory-sealed hybrid systems supports up to 6 RRHs and connects the remote radios with easy-to-install Q-ODC fiber optic and power jumpers. A pre-laced hoisting grip below the robust connector head allow for easy cable lifting. The encapsulated connector head can be directly hooked in to a pre-mounted bracket.

The MLUH head has an integral earth point which can be connected to an earth lead with M8 ring terminal. Optional, the shielding of the hybrid cable can be grounded with standard grounding kits.

The hybrid cable is designed in a way that the outer jacket and shielding can be easily stripped off over a distance of several meters. This allows the installer to cut the excess length of the copper wire while the overlength of the pre-terminated fiber cable is stored inside the base station or in an overlength box.

These unique features make MASTERLINE Ultimate Hybrid the best-in-class product in terms of ease of mast-top installation, installation robustness and efficiency.



MASTERLINE Ultimate Hybrid (MLUH) with Q-ODC-12



Features

- Pre-connectorised factory-sealed hybrid cable system with 3 power connectors and 3 Q-ODC-12 connectors
- Modular „plug & play“ system compatible with Q-ODC-12 jumpers
- Encapsulated IP67 sealed connector head housing
- Hoisting grip for cable lifting
- Space-efficient, low wind-load
- Mounting bracket for easy mast-, pole- and wall-installation
- Integral earth point which can be connected to an earth lead with M8 ring terminal
- Optional protection cover for cable exits available

Specifications

Number of rugged circular power sockets		3
Number of Q-ODC-12 sockets		3 (12 fibers per socket)
Dimensions L x W x H		310 x 90 x 97 mm
Rated current		up to 42 A per power socket
Ambient temperature range	in service	-40 to +75 °C
	installation	-10 to +50 °C
Ingress protection (IEC 60529)		IP67
Impact resistance (IEC 62262) IK 10		IK 10
Material housing		high-performance polycarbonate
UV resistant for outdoor use		EN ISO 4892-3:2016
Material flammability rating		UL94-V0

MASTERLINE Ultimate Hybrid with Q-ODC-12 allows the connection to 18 remote radio interfaces and 3 power supply units.

The MLUH connector head is equipped with 3 power connectors and 3 Q-ODC-12 sockets.

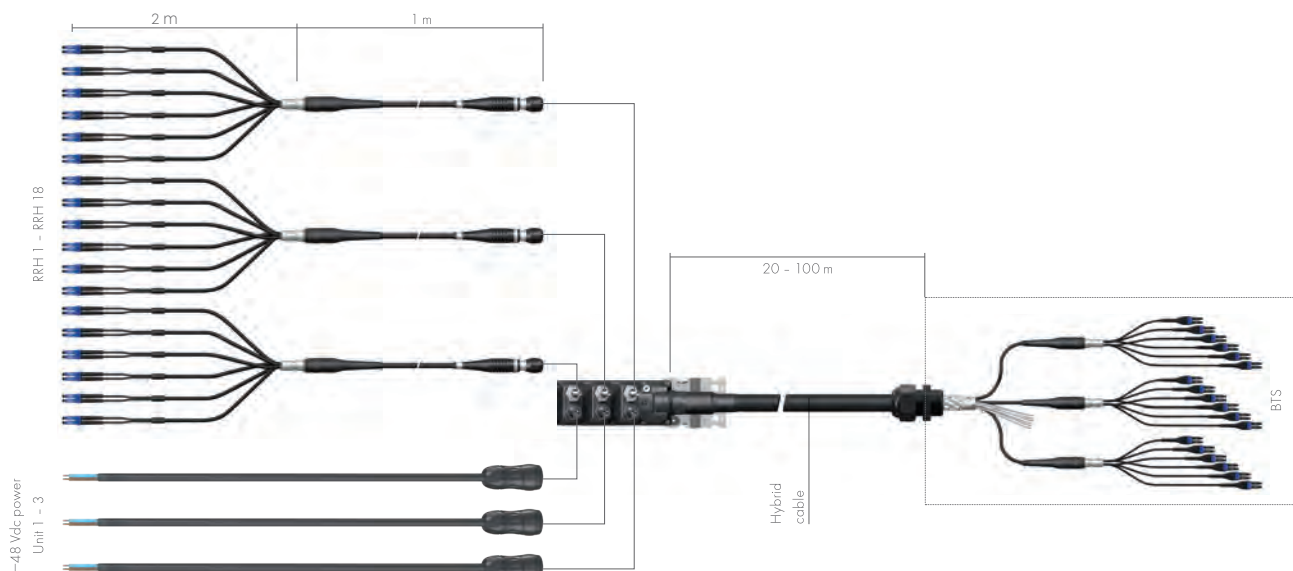

MASTERLINE Ultimate Hybrid (MLUH) with Q-ODC-12

Q-ODC-12 connector



Q-ODC-12 plug on the multi-branch RRH jumper



Q-ODC-12 socket on MLUH head

Features

- Connects 12 fibers in one mating step
- Compact design with MT ferrules
- Robust push-pull coupling mechanism – two clearly defined mating states
- Highest outdoor installation safety
- Waterproof, dust proof and corrosion resistant

Specifications on page 145.

Mating/unmating sequences

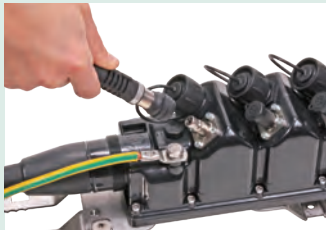

Push plug connector slightly into extension connector, rotate to find keying position, push connector to mate.



Mated – connector snaps in and is fully strain relieved.



Pull coupling ring to unmate.

MASTERLINE Ultimate Hybrid (MLUH) with Q-ODC-12

Ordering information

MASTERLINE Ultimate Hybrid with 3 power connector and 18 fiber optic interfaces – MLUH 3/18



	Radio end side	BTS side
Fiber optic	3 Q-ODC 12 sockets	18 LC uniboot
Power	3 rugged circular plastic sockets	3 pairs of wire blunt cut wire, cross section 6 mm ² , 10 mm ² , 16 mm ² , AWG 10, AWG 8, AWG 6

Hybrid cable	Market	Length	Item no.		
			6 mm ²	10 mm ²	
6 pairs conductor 6 pairs fiber optic single-mode A9/125 A2	global not UL listed CPR compliant	20 m	85098395		
		30 m	85098396		
		40 m	85098397		
		50 m	85098398		
		60 m		85098399	
		70 m		85098400	
		80 m		85098401	
		90 m		85098402	
		100 m		85098403	
	US UL listed			AWG 10	AWG 8
		20 m	85098404		
		30 m	85098405		
		40 m	85098406		
		50 m	85098407		
		60 m		85098408	
		70 m		85098409	
		80 m		85098410	
		90 m		85098411	
100 m		85098412			

Options

- Multimode OM3
- Other length
- 16 mm²/AWG 6

MASTERLINE Ultimate Hybrid (MLUH) with Q-ODC-12

Q-ODC-12 multi-branch RRH jumper



Features

- Terminated with Q-ODC-12 plug and with 6 RRH-specific interfaces
- Connects 6 RRH jumper cables with a single „click“
- Ruggedised design with robust breakout cables
- Cable diameter 4.8 mm, 5.5 mm or 7 mm
- RRH-specific interface numbered for easy channel identification
- Ingress protection IP rating (Q-ODC-12, mated)

Ordering information see page 52 (MLE with Q-ODC-12).

Power jumpers













Features

- Compatible with MLUP, MLEP, MLUH and MLEH
- Terminated with a rugged circular plastic plug connector and blunt cut on the RRH side
- 2 wire shielded copper cable with a cross section of 4 mm² to 10 mm² and AWG 12 to AWG 8
- Standard length 2, 5 and 10 m

Ordering information see page 43 (MLUP).

MASTERLINE Ultimate Hybrid (MLUH)

Accessories

Description		Item no.	Page	Picture
Overlength box for outdoor and indoor installation, stores up to 20 m cable excess length (depending on cable diameter)		84103325	127	
Clamps for hybrid cable		depends on cable diameter	134	
Grounding kits		85015070	138	
Grounding cable, 0.5 m, 16 mm ² and 25 mm ² , black and yellow/green		depends on cross section and colour	139	
19" CTB patching box	6, 12, 18 or 24 LC duplex adapter blue	depends on quantity of LC adapter	130	
LC patchcords	0.5 m, 0.7 m or 1 m length, single-mode	depends on length	133	
Protection cover for MLUH 3 Stainless steel Dimension (L x H x W) 365 x 200 x 90 mm		85032157	--	
Protection cover for MLUH 6 Stainless steel Dimension (L x H x W) 550 x 250 x 90 mm		85032156	--	
Auxiliary tool to open and close power connector		85013939	--	
Quick hose clamps Stainless steel One set includes 2 pieces hose clamps	clamping Ø 30 to 155 mm	84076411	140	
	clamping Ø 60 to 500 mm	84076412		
SFP/SFP+ transceivers for different protocols, data rates and power budgets.		see transceiver selection guide on page 260	259	

MASTERLINE Extreme Hybrid (MLEH)

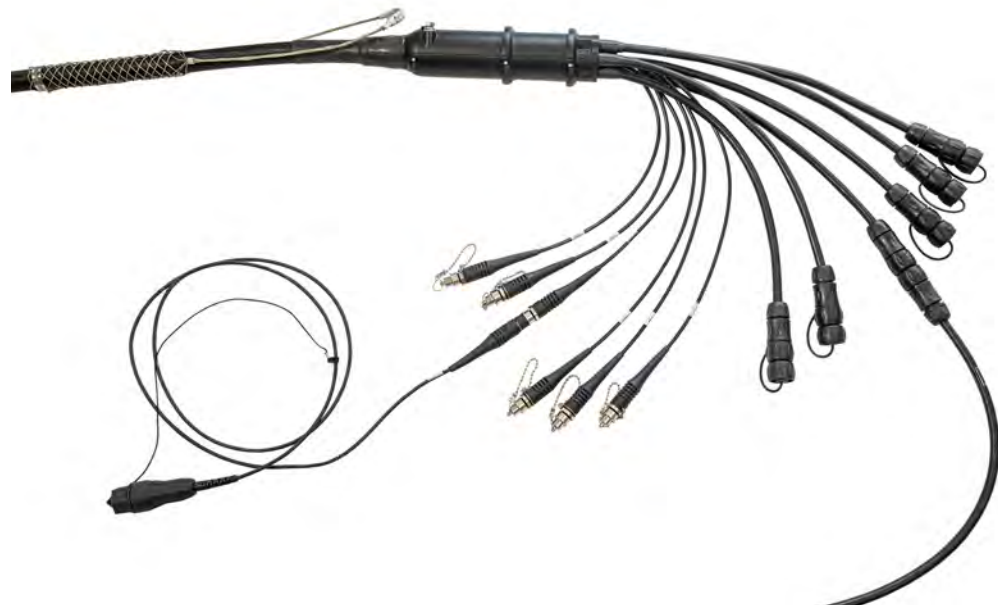

Hybrid-riser cable with compact divider

The hybrid cabling system of HUBER+SUHNER is the most efficient and easiest to install product available on the market. Mobile operators on four continents verified that MASTERLINE Extreme Hybrid can be installed in half of the time of competitive hybrid solutions based on corrugated coax cable designs. The factory-terminated „plug & play“ system in combination with a highly flexible and easy-to-route cable makes the HUBER+SUHNER solution the hybrid cable of choice for operators, system vendors and installers alike.

The pre-terminated hybrid cable assembly minimises the quantity of cables running up the mast. The compact divider splits the optical fiber and DC power cable into individual ruggedised outdoor cables which are linked to the RRHs – either directly or via extension jumpers without the need for bulky mast mount distribution boxes. The RRH jumpers allow an adaptation to different RRH interfaces and therefore make the solution independent from the system vendor's hardware.

MASTERLINE Extreme Hybrid (MLEH)

RF

LISCA RF jumper

page 162



FTTA

Q-ODC RRH jumpers

page 30



PTTA

Power jumpers (optional)

page 43



HTTA

MASTERLINE Extreme Hybrid

page 100



XTTA

Cable clamps

page 134



FTTA

CTB 19" patching box (optional)

page 130

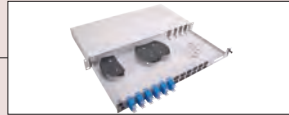

FTTA

LC patchcord (optional)

page 133

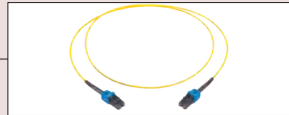

XTTA FTTA, PTTA and HTTA

RF Radio Frequency

FTTA Fiber-To-The-Antenna

PTTA Power-To-The-Antenna

HTTA Hybrid-To-The-Antenna

MASTERLINE Extreme Hybrid (MLEH)

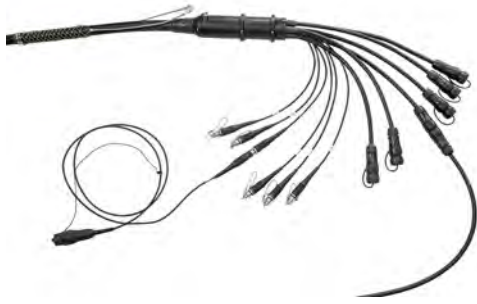

Features

- Hybrid cabling system for up to 9 RRHs
- Highly flexible hybrid cable with low bending radius and excellent cable routing properties
- Overlength management – cable jacket with ripcords for easy and quick stripping
- Ruggedised powder coated aluminum with robust breakout cables
- Mounting bracket for easy mast-, pole- and wall-installtion
- Hoisting grip for cable lifting
- Supplied on double-flange reels for straight forward unspooling
- Fiber optic breakout cables terminated with Q-ODC extensions to connect with Q-ODC RRH jumpers
- Power cable connectorised or blunt cut
- Integral earth point which can be connected to an earth lead with M8 ring terminal

Specifications

		Small divider	Large divider
Number of power wire pairs/connectors		up to 6	up to 9
Number of fiber optic pairs/Q-ODC-2 extension connectors		up to 8	up to 18
Housing material		Powder coated aluminum	
Rated current		up to 40A per RRH (depending on the hybrid cable)	
Dimensions		length 253 mm, Ø 76 mm	length 225 mm, Ø 97 mm
Temperature range (IEC 60529)	in service	-40 to +75 °C	
	during installation	-10 to +50 °C	
Impact resistance (IEC 62262)	radio end	IP67	
	base station	IP65 (with protection tube)	
IK class		IK 10	
UV resistance, ISO 4892-3 (methode A/cylce 1)		1000 h	



MASTERLINE Classic at BTS side



Hoisting grip for hybrid cable lifting



Integral earth connection

MASTERLINE Extreme Hybrid (MLEH)

Hybrid cable general specifications

	LSFH™ hybrid cable, global market	UL listed hybrid cable, US market
Jacket material	thermoplastic, LSFH™	PVC
Standard	IEC 60502-1:2004-04	UL 1277, TC-OF-ER
Rated voltage	0.6 kV/1 kV (1.2 kV)	
Min. bending	during installation	10 × cable Ø
	in service	8 × cable Ø
Cable shielding	copper foil 100 % coverage (contacted with drain wire)	
Conductor type	IEC 60228 class 5	class C THHN/THWN-2
Flame retardant	IEC 60332-1-2:2004	UL 1685 (UL 1581) vertical tray flame test
CPR compliant	yes, class Dca	no

Hybrid cable specification MLEH 3/3 or MLEH 3/6

	LSFH™ hybrid cable, global market			UL listed hybrid cable, US market		
	6 mm ²	10 mm ²	16 mm ²	AWG 10	AWG 8	AWG 6
Conductor cross section	6 mm ²	10 mm ²	16 mm ²	AWG 10	AWG 8	AWG 6
Resistance	3.08 Ω/km	1.83 Ω/km	1.21 Ω/km	3.41 Ω/km	2.13 Ω/km	1.30 Ω/km
Maximum current rating	31 A	42 A *	42 A *	26 A	36 A	44 A *
Outer diameter	22 mm	22 mm	27.5 mm	19.6 mm (0.77")	23.4 mm (0.92")	23.9 mm (0.945")
Weight	0.73 kg/m	0.96 kg/m	1.36 kg/m	0.69 kg/m	1.05 kg/m	1.4 kg/m
Drain wire cross section	6 mm ²	10 mm ²	10 mm ²	AWG 6	AWG 6	AWG 6
Fiber optic	5 mm loose tube cable with 6 or 12 fibers single-mode E9/125 A2 or multimode OM3					

Hybrid cable specification MLEH 6/6 or MLEH 6/12

	LSFH™ hybrid cable, global market			UL listed hybrid cable, US market		
	6 mm ²	10 mm ²	16 mm ²	AWG 10	AWG 8	AWG 6
Conductor cross section	6 mm ²	10 mm ²	16 mm ²	AWG 10	AWG 8	AWG 6
Resistance	3.08 Ω/km	1.83 Ω/km	1.21 Ω/km	3.41 Ω/km	2.13 Ω/km	1.30 Ω/km
Maximum current rating	26 A	35 A	42 A *	16 A	23 A	31 A
Outer diameter	27.5 mm	28 mm	36 mm	25.4 mm (1.00")	30.0 mm (1.18")	33.0 mm (1.28")
Weight	1.17 kg/m	1.72 kg/m	2.46 kg/m	1.25 kg/m	1.64 kg/m	2.28 kg/m
Drain wire cross section	6 mm ²	10 mm ²	10 mm ²	AWG 6	AWG 6	AWG 6
Fiber optic	5 mm loose tube cable with 12 or 24 fibers single-mode E9/125 A2 or multimode OM3					

Hybrid cable specification MLEH 9/9 or MLEH 9/18

	LSFH™ hybrid cable, global market		UL listed hybrid cable, US market	
	6 mm ²	10 mm ²	AWG 10	AWG 8
Conductor cross section	6 mm ²	10 mm ²	AWG 10	AWG 8
Resistance	3.08 Ω/km	1.83 Ω/km	3.41 Ω/km	2.13 Ω/km
Maximum current rating	22 A	30 A	16 A	23 A
Outer diameter	36 mm	36 mm	29 mm (1.14")	36 mm (1.42")
Weight	1.17 kg/m	1.72 kg/m	1.25 kg/m	1.64 kg/m
Drain wire cross section	6 mm ²	10 mm ²	AWG 6	AWG 6
Fiber optic	5 mm loose tube cable with 12 fibers single-mode E9/125 A2 or OM3			

* limitation through power connector maximum current rating 42 A (IEC) and 44 A (UL)





MASTERLINE Extreme Hybrid (MLEH)

Easiest-to-install hybrid product available on the market.

The easy way to your installation instructions „Please consider the environment before printing“. With this well-known statement in mind we have decided to stop printing installation manuals. As of today the hybrid cable system spools from HUBER+SUHNER fiber optics will feature a QR code. Whilst on site, scanning it with your smartphone or tablet takes you directly to the relevant online installation instructions. Just scan the QR code and choose installation manual or video to get exclusive installation support by HUBER+SUHNER. This approach works with any available QR code scanner for mobile devices.

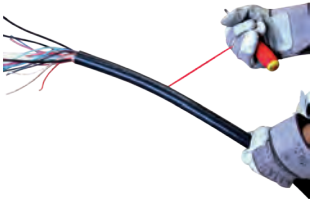

Installation features

	<p>Unspooling The MLEH is supplied on a double-flange reel which allows for easy and straight-forward unspooling while lifting the cable up the mast.</p>
	<p>Lifting The radio end is equipped with a robust braided sleeve with pulling eye which protects and keeps the break-out cables in vertical position during installation. With the hoisting grip, attached below the divider, the cable system is lifted up to the mast.</p>
	<p>Fixation The MLEH mounting bracket has a snap-in mechanism for quick and easy fixation of the divider housing. The clips can be closed by hand without any tool.</p>
	<p>Earthing The MLEH enclosure has an integral earth point which can be connected to an earth lead with M8 ring terminal. Optional, the shielding of the hybrid cable can be grounded with standard grounding kits.</p>
	<p>Base station connection The pre-terminated LC fiber optic connectors are protected with a IP65 protection tube. Once the protection tube is screwed-off, the installer has access to the fiber optic break-out cables and the individual copper/ground wires.</p>
	<p>Overlength management The hybrid cable is designed in a way that the outer jacket and shielding can be easily stripped off with a ripcord over a distance of several meters. This allows the installer to cut the excess length of the copper wire while the overlength of the pre-terminated fiber cable is stored inside the base station or in an overlength box.</p>

MASTERLINE Extreme Hybrid (MLEH)

Available configurations

Configuration	Pairs of power wires	Pairs of fiber optic	Market	Wire cross section	Power breakout	Fiber optic breakout
MLEH 3/3	3	3	global US	6, 10, 16 mm ² 10, 8, 6, 4 AWG	connectorised or blunt cut	Q-ODC or ODC on radio end
MLEH 3/6	3	6	global US	6, 10, 16 mm ² 10, 8, 6, 4 AWG	6 or 10mm ² 10 or 8 AWG	LC uniboot on base station side
MLEH 6/6	6	6	global US	6, 10, 16 mm ² 10, 8, 6, 4 AWG		
MLEH 6/12	6	12	global US	6, 10, 16 mm ² 10, 8, 6, 4 AWG		
MLEH 9/9	9	9	global US	6, 10 mm ² 10, 8 AWG		
MLEH 9/18	9	18	global US	6, 10 mm ² 10, 8 AWG		

Q-ODC-2 connectors



Q-ODC plug on the jumper

Q-ODC extension on the MLEH

MASTERLINE Extreme Hybrid allow for quick and reliable connections of fiber optic jumpers. The fiber optic connector Q-ODC has a robust push-pull coupling mechanism with two clearly defined mating states for highest outdoor installation safety.

Specification see page 145 (fiber optic interfaces).

Power connectors



Power connector plug at the jumper

Power connector extension at the MLEH (0.5 m long breakout)

The power breakout cables are either direct connected to the screw terminals of the RRHs or via power jumper, which are terminated with a rugged circular connector. The power connectors have a bayonet coupling system which enables a simple and fast mating. With only a 1/3 twist of the coupling ring, connectors are mated with an audible and sensitive „click“. The machined 3.6 mm crimp contact ensure a vibration safe termination and a high current rating.

Specification see page 41 (MLUP).

Hybrid cable

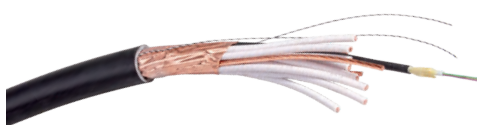

Hybrid cable with 6 pairs power wire and 6 pairs of fiber optic

Hybrid cables of HUBER+SUHNER combine optical fiber and DC power, are highly flexible and easy-to-route. Two rip cords between the shielding and the jacket allows a quick stripping of the jacket. The shielding, a copper foil under the jacket and the drain wire maintain contact throughout the cable run and allow potential equalisation and a safe installation with regard to lightning strikes.

MASTERLINE Extreme Hybrid (MLEH)

Ordering information

MASTERLINE Extreme Hybrid for 3 RRHs – MLEH 3/3



	Radio end side	BTS side
Fiber optic	Q-ODC breakout length 0.50 m	LC uniboot
Power	blunt cut wire cross section 6 mm ² /AWG 10 breakout length 4 m	blunt cut wire cross section 6 mm ² /AWG 10 or 10 mm ² /AWG 8

Power wire	Fiber optic	Market	Jacket material	Wire cross section Cable diameter Cable weight	Length	Item no.	
3 pairs	3 pairs single-mode	global not UL listed CPR compliant	LSFH™	6 mm ² 22 mm (5/8") 0.73 kg/m	10 m	85006998	
					20 m	85006999	
					30 m	85007000	
					40 m	85007001	
					50 m	85007002	
				10 mm ² 22 mm (5/8") 0.96 kg/m	60 m	85007003	
					70 m	85007004	
					80 m	85007005	
					90 m	85007006	
					100 m	85007007	
		US 	PVC	AWG 10 19.6 mm (0.77") 0.69 kg/m	10 m	85007008	
					20 m	85007009	
					30 m	85007010	
					40 m	85007011	
					50 m	85007012	
					AWG 8 23.4 mm (0.92") 1.40 kg/m	60 m	85007013
						70 m	85007014
80 m	85007015						
90 m	85007016						
100 m	85007017						

Options

- Multimode fiber
- Other length
- 16 mm² or AWG 6 conductors
- Power breakout with power connector

MASTERLINE Extreme Hybrid (MLEH)

Ordering information

MASTERLINE Extreme Hybrid for 3 RRHs – MLEH 3/6 with power connector



	Radio end side	BTS side
Fiber optic	Q-ODC breakout length 0.50 m/0.62 m	LC uniboot
Power	power connector wire cross section 6 mm ² breakout length 0.50 m	blunt cut wire cross section 6 mm ² or 10 mm ²

Power wire	Fiber optic	Market	Jacket material	Wire cross section Cable diameter Cable weight	Length	Item no.
3 pairs	6 pairs single-mode	global not UL listed CPR compliant	LSFH™	6 mm ² 22 mm (5/8") 0.73 kg/m	10 m	85173472
					20 m	85011141
					30 m	85011142
					40 m	85009251
					50 m	85011143
				10 mm ² 22 mm (5/8") 0.96 kg/m	60 m	85011154
					70 m	85011155
					80 m	85011156
					90 m	85011157
					100 m	85011158

Options

- Multimode fiber
- Other length
- 16 mm² or AWG 6 conductors
- Power breakout 4 m blunt cut
- UL listed hybrid cable

MASTERLINE Extreme Hybrid is currently deployed nationwide in US

Two US operators (T-Mobile and Sprint) have selected MLEH for their nationwide network rollout. No other hybrid cabling system can be installed faster and more efficiently. The „plug & play“ solution has excellent installation features like robust pulling tubes or a field-manageable method to strip and cut the excess power cable at the base station. These unique features convince operators and installers at the same time – there no other hybrid solution which comes close.



MASTERLINE Extreme Hybrid (MLEH)

Ordering information

MASTERLINE Extreme Hybrid for 6 RRHs – MLEH 6/6 with power connector



	Radio end side	BTS side
Fiber optic	Q-ODC breakout length 0.50 m/0.62 m	LC uniboot
Power	power connector wire cross section 6 mm ² breakout length 0.5 m/0.62 m	blunt cut wire cross section 6 mm ² or 10 mm ²

Power wire	Fiber optic	Market	Jacket material	Wire cross section Cable diameter Cable weight	Length	Item no.
6 pairs	6 pairs single-mode	global not UL listed CPR compliant	LSFH™	6 mm ² 27.5 mm (7/8") 1.17 kg/m	10 m	85001318
					20 m	85001319
					30 m	85001320
					40 m	85001321
					50 m	85001322
				10 mm ² 28 mm (7/8") 1.72 kg/m	60 m	85001323
					70 m	85001324
					80 m	85001325
					90 m	85001326
					100 m	85001327

Options

- Multimode fiber
- Other length
- 16 mm² or AWG 6 conductors
- UL listed hybrid cable

Customer voices – best system to install

Installers are impressed by how easy and fast the MASTERLINE Extreme Hybrid can be installed. An experienced rigger in UK brought it to the point: „This is the best system to install“. The HUBER+SUHNER hybrid cable is flexible, easy to pull up the mast and to route inside of conduits or monopoles. Competitive solutions suffer from stiff corrugated cables designs and a Latin American operator wrote in an installation report „difficult to install due to cable’s inflexibility, handling problems to install the cable up the mast, long time to install the boxes on the top“.

The HUBER+SUHNER MLEH is a boxless solution, all connectors have quick-lock mechanisms and overlength management is efficiently solved.



MASTERLINE Extreme Hybrid (MLEH)

Ordering information

MASTERLINE Extreme Hybrid for 6 RRHs – MLEH 6/6



	Radio end side	BTS side
Fiber optic	Q-ODC breakout length 0.50 m/0.62 m	LC uniboot
Power	blunt cut wire cross section 6 mm ² /AWG 10 breakout length 4 m	blunt cut wire cross section 6 mm ² /AWG 10 or 10 mm ² /AWG 8

Power wire	Fiber optic	Market	Jacket material	Wire cross section Cable diameter Cable weight	Length	Item no.	
6 pairs	6 pairs single-mode	global not UL listed CPR compliant	LSFH™	6 mm ² 27.5 mm (7/8") 1.17 kg/m	10 m	85020114	
					20 m	85014799	
					30 m	85014800	
					40 m	85014801	
					50 m	85014802	
				10 mm ² 28 mm (7/8") 1.72 kg/m	60 m	85014798	
					70 m	85014797	
					80 m	85014796	
		US 	PVC	AWG 10 25.4 mm (1.00") 1.25 kg/m	10 m	85020115	
					20 m	85020116	
					30 m	85020117	
					40 m	85020118	
					50 m	85020119	
					AWG 8 30.0 mm (1.18") 1.80 kg/m	60 m	85020120
						70 m	85020121
						80 m	85020122
90 m	85020123						
100 m	85020124						

Options

- Multimode fiber
- Other length
- 16 mm² or AWG 6 conductors

MASTERLINE Extreme Hybrid (MLEH)

Ordering information

MASTERLINE Extreme Hybrid for 6 RRHs – MLEH 6/12
12 × Q-ODC



	Radio end side	BTS side
Fiber optic	Q-ODC breakout length 0.50 m/0.62 m/0.74 m/0.86 m	LC uniboot
Power	blunt cut wire cross section 6 mm ² /AWG 10 breakout length 4 m	blunt cut wire cross section 6 mm ² /AWG 10 or 10 mm ² /AWG 8

Power wire	Fiber optic	Market	Jacket material	Wire cross section Cable diameter Cable weight	Length	Item no.
6 pairs	12 pairs single-mode	global not UL listed CPR compliant	LSFH™	6 mm ² 27.5 mm (7/8") 1.17 kg/m	10 m	85173473
					20 m	85019958
					30 m	85173475
					40 m	85019960
					50 m	85173476
				10 mm ² 27.5 mm (7/8") 1.72 kg/m	60 m	85019962
					70 m	85173477
					80 m	85019964
					90 m	85173478
					100 m	85173479
		US 	PVC	AWG 10 25.4 mm (1.00") 1.25 kg/m	10 m	85019974
					20 m	85019976
					30 m	85019977
					40 m	85019978
					50 m	85019979
					AWG 8 30.0 mm (1.18") 1.80 kg/m	60 m
70 m	85019981					
80 m	85019982					
90 m	85019983					
100 m	85019984					

Options

- Multimode fiber
- Other length
- 16 mm² or AWG 6 conductors
- Power breakout with power connector

MASTERLINE Extreme Hybrid (MLEH)

Ordering information

MASTERLINE Extreme Hybrid for 9 RRHs – MLEH 9/18
18 × Q-ODC

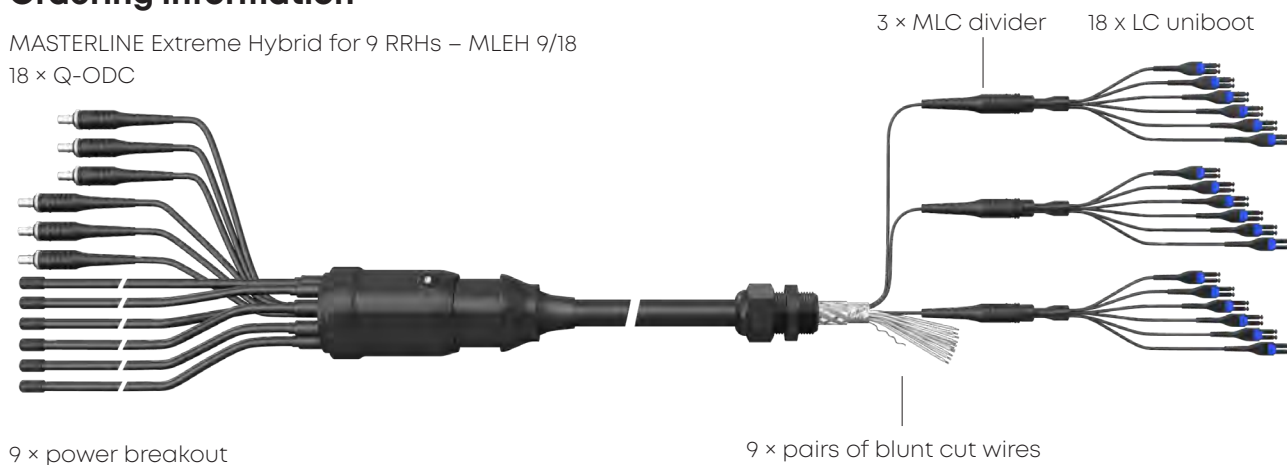

	Radio end side	BTS side
Fiber optic	Q-ODC breakout length 0.50 m/0.62 m/ 0.74 m/0.86 m/0.98 m/1.10 m	LC uniboot
Power	blunt cut wire cross section AWG 10 breakout length 4 m	blunt cut wire cross section 6 mm ² /AWG 10 or 10 mm ² /AWG 8

Power wire	Fiber optic	Market	Jacket material	Wire cross section Cable diameter Cable weight	Length	Item no.		
9 pairs	18 pairs single-mode	global not UL listed CPR compliant	LSFH™	6 mm ² 36.0 mm 1.90 kg/m	10 m	85021731		
					20 m	85021732		
					30 m	85021733		
					40 m	85021734		
					50 m	85021735		
				10 mm ² 36 mm 2.61 kg/m	60 m	85021736		
					70 m	85021737		
					80 m	85021738		
					90 m	85021739		
					100 m	85021740		
		US 		PVC		AWG 10 29.2 mm (1.15") 1.67 kg/m	10 m	85007085
							20 m	85007087
							30 m	85007088
							40 m	85007089
							50 m	85007090
						AWG 8 36.8 mm (1.45") 2.48 kg/m	60 m	85007091
70 m	85007092							
80 m	85007093							
90 m	85007094							
100 m	85007095							

Options

- Multimode fiber
- Other length
- Power breakout with power connector

MASTERLINE Extreme Hybrid (MLEH)

Q-ODC RRH jumpers



Features

- Compatible with MLE, MLEH, MLU and MLUH terminated with Q-ODC
- Ruggedised and robust RRH jumper cable – easy and reliable to install
- Available for all types of RRH
- Cable diameter 4.8 mm, 5.5 mm or 7 mm
- Standard lengths of 2, 5 and 10 m, customised lengths available

Jumpers for all types of remote radio systems available. Ordering information see page 30 (MLU).

Power jumpers



Features

- Compatible with MLEP, MLEH and MLUH
- Terminated with a rugged circular plastic plug connector and blunt cut on the RRH side
- 2 wire shielded copper cable with a cross section of 4 or 6 mm²/ AWG 10
- Standard length 2, 5 and 10 m

Ordering information see page 43 (MLUP).

Global supply chain for hybrid assemblies

HUBER+SUHNER operates hybrid assembly shops in Poland, Mexico, China and has plans to expand the manufacturing network to other regions as well. Being close to our customers is a must for bulky hybrid assemblies with weights exceeding 100 kg.

Our operations network enables HUBER+SUHNER to respond immediately to our customers' needs and to provide a fast and flexible delivery performance.



MASTERLINE Extreme Hybrid (MLEH)

Power connectors



Power connector plug at the jumper

Power connector extension at the MLEH (0.5 m long breakout)

Features

- Rugged circular plastic plug connector for remote radio installations
- Machined crimp contacts Ø 3.6 mm for high current
- Bayonet coupling system for easy and quick mating
- 2 wire shielded copper cable with cross section of 4 or 6 mm²/AWG 10

MASTERLINE Extreme Hybrid is optional available with a rugged circular plastic power connector. The bayonet coupling system enables a simple and fast mating. With only a 1/3 twist of the coupling ring, connectors are mated with an audible and tactile „click“. The machined 3.6 mm crimp contacts ensure a vibration safe termination and a high current rating.

Mating/unmating sequences



Twist the coupling ring of the power jumper plug connector to remove protecting cap as shown.



Twist the coupling ring of the MLEH receptacle connector to remove protecting cap as shown.



Push plug connector slightly into receptacle connector, rotate to find keying position.



Twist coupling ring of the power jumper plug connector to mate the connectors as shown.

Accessories

Description	Item no.	Page	Picture
Mounting bracket with 2 clips for MLEH small with snap-in mechanism for fixation of the divider housing. The UV resistant clips can be closed by hand without any tool.	85140742	140	
Mounting bracket with 1 double-clip for MLEH large with snap-in mechanism for fixation of the divider housing. The UV resistant clips can be closed by hand without any tool.	85140743	140	

MASTERLINE Extreme Hybrid (MLEH)

Accessories

Description		Item no.	Page	Picture
Overlength box for outdoor and indoor installation, stores up to 20 m cable excess length (depending on cable diameter)		84103325	127	
Clamps for hybrid cable		depends on cable diameter	134	
Grounding kits		85015070	138	
Grounding cable, 0.5 m, 16 mm ² and 25 mm ² , black and yellow/green		depends on cross section and colour	139	
19" CTB patching box	6, 12, 18 or 24 LC duplex adapter blue	depends on quantity of LC adapter	130	
LC patchcords	0.5 m, 0.7 m or 1 m length, single-mode	depends on length	133	
3 fold cable clamp suitable for ODC boot to fix the Q-ODC extension connectors		85012939	136	
6 fold cable clamp suitable for 3 ODC boot and 3 power connectors		85028293	134	
Quick hose clamps Stainless steel One set includes 2 pieces hose clamps	clamping Ø 30 to 155 mm	84076411	140	
	clamping Ø 60 to 500 mm	84076412		
SFP/SFP+ transceivers for different protocols, data rates and power budgets		see transceiver selection guide on page 260	259	



MASTERLINE Classic Hybrid (MLCH)

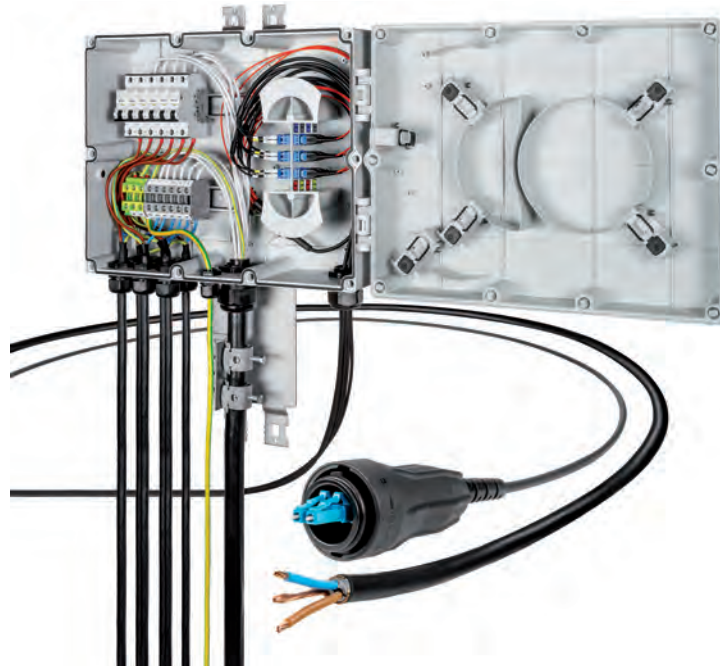

Hybrid-riser cable with distribution box

This solution, a factory-terminated hybrid-riser cable assembly, minimises the amount of cables running up the mast. At the hybrid distribution box the multifiber/wire cable are split into individual cables which are linked to the RRHs with short jumper cables. The jumpers allow an adaptation to different RRH interfaces and therefore make the solution independent from the system vendor's hardware. A box solution enables the use of circuit breaker and/or surge protection devices.

However, this installation method requires large and bulky boxes on the top of the mast. With increasing number of remote ratios per site, space limitations and wind load become critical issues. Many operators also want to avoid the risk of opening and maintaining mast-top boxes by non-trained or non-authorized persons.

MASTERLINE Classic Hybrid (MLCH)

RF LISCA RF jumper
page 162



FTTA LC duplex RRH jumpers
page 66



PTTA Power cable
page 68



HTTA HTTA distribution box
page 120



HTTA MASTERLINE Classic Hybrid
page 116



XTTA Cable clamps
page 134



FTTA CTB 19" patching box (optional)
page 130



FTTA LC patchcord (optional)
page 133

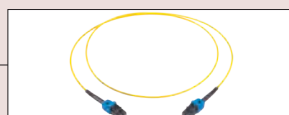

XTTA FTTA, PTTA and HTTA

PTTA Power-To-The-Antenna

RF Radio Frequency

HTTA Hybrid-To-The-Antenna

FTTA Fiber-To-The-Antenna

MASTERLINE Classic Hybrid (MLCH)

Distribution box

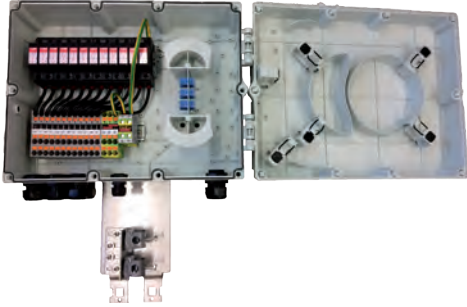

Features





- Ruggedised outdoor distribution box for fiber optic and power supply
- Supports up to 6 remote radio heads
- Fitted with bend radius limiting mandrels
- Power distribution up to 15 A per remote radio head
- Optional with circuit breaker or/and surge protection devices
- Cover stores up to 20 m fiber optic cables excess length
- Suitable for mounting on poles, walls and tower legs
- Easy to mount and install with pre-mounted brackets
- Hybrid cable clamp integrated on mounting brackets
- Protective vent to equalise pressure and prevent condensation

Specifications

Number of RRH		up to 6 RRH
Compatible with MASTERLINE Classic Hybrid		up to 12 fibers and up to 12 power wire
Box dimensions		429 × 390 × 159 mm
U_N rated voltage		-48 V DC
I_N rated current per RRH	without circuit breaker	15.0 A
	with circuit breaker	11.7 A
Ambient temperature range	operation	-40 to +75 °C (with CB +55 °C)
	installation	-10 to +50 °C
Box material		glass-filled polycarbonate
Ingress protection		IP67
Impact resistance		IK 07 (EN 62262)
Colour		RAL 7035 grey
Halogen-free		IEC 60754-2
UV resistant for outdoor use		ISO 4892-3
Material flammability rating		UL94-V0
Screw terminals	cable entry	6 mm ² to 16 mm ² (25 mm ² without wire end sleeves)
	cable exit	4 mm ² to 6 mm ²
Circuit breaker (optional)		miniature circuit breaker C 20 A
Surge protection device (optional)		SPD type 1+2/class I+II or type 2/class II, specifications see page 74

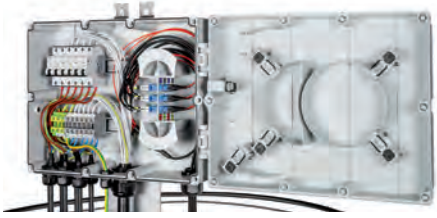
MASTERLINE Classic Hybrid (MLCH)

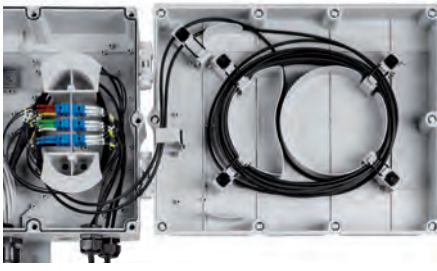
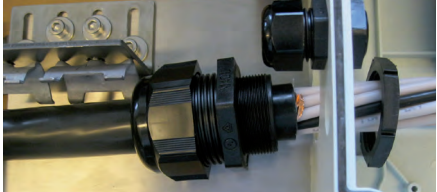
Distribution box – installation features

	<p>Pre-installed power distribution and fiber management components Pre-installed screw terminals and optional circuit breaker and/or surge protection device for up to 6 RRHs. Bend radius limiting mandrels and an LC duplex adaptor plate ensure safe fiber management. Glands for power and fiber optic jumper cable are pre-mounted.</p>
	<p>Pulling The HTTA box has a robust mounting bracket with which the box and hybrid cable can be lifted up the mast.</p>
	<p>Overlength management in cover Up to 20 m of jumper or multi-riser cable can be stored in the cover. The cable is routed and retained to allow for easy opening/closing of the cover without affecting the cable excess length.</p>
	<p>Cable entry A knock-out holes with $\text{Ø} 40.0$ mm in the middle of the bottom allows to enter the MLCH with its pre-mounted M40 cable gland.</p> <ul style="list-style-type: none"> • 1 × M40 cable gland for MLCH $\text{Ø} 18.0$ to 32.0 mm As an option, the HTTA box can be used for an installation with 1 or 2 power main cables and a separate multifiber riser cable (MLC) instead of a hybrid cable. • 1 × M40 cable gland for power main cable $\text{Ø} 16.0$ to 28.0 mm • 1 × M32 cable gland for an optional 2nd power main cable $\text{Ø} 18.0$ to 25.0 mm • 1 × hole 16 mm for MLC 12 fibers and 1 × hole 26 mm or for MLC 24 fibers
	<p>Cable exits The standard configuration is designed for 6 fiber optic and power jumper cables with the option to increase the number of fiber optic jumpers up to 12. The HTTA box can be electrically grounded with a 16 mm² earthing cable through a M20 cable gland.</p> <ul style="list-style-type: none"> • 1 × M32 cable gland with 6-fold seal for 6 jumper cable $\text{Ø} 4.8$ to 7.0 mm • 6 × M25 cable glands for 6 power main cable $\text{Ø} 9.0$ to 16.0 mm • 1 × M20 cable gland for earthing cable $\text{Ø} 6.0$ to 12.0 mm

MASTERLINE Classic Hybrid (MLCH)

Ordering information distribution box

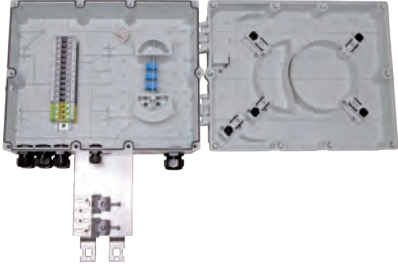
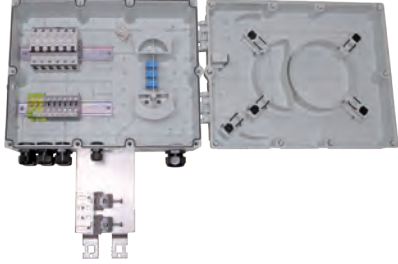
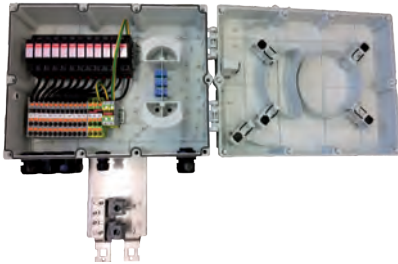
Description	Item no.	Picture
<p>HTTA box power distribution only</p> <ul style="list-style-type: none"> Screw terminals for 12-wire hybrid cable up to 16 mm² (25 mm²) and 6 power jumper, individual power supply circuits 6 LC duplex adapter (single-mode, blue) 6 cable gland for power jumper, 1 cable gland for 6 fiber optic jumper, 1 cable gland for earthing cable Mounting bracket with 2 cable clamps for MLCH Quick hose clamp for Ø 60 to 500 mm 	84143745	
<p>HTTA box with circuit breaker</p> <ul style="list-style-type: none"> Screw terminals for 12-wire hybrid cable up to 16 mm² (25 mm²) and 6 power jumper, individual power supply circuits 6 circuit breaker 20A with C tripping characteristic 6 LC duplex adapter (single-mode, blue) 6 cable gland for power jumper, 1 cable gland for 6 fiber optic jumper, 1 cable gland for earthing cable Mounting bracket with 2 cable clamps for MLCH Quick hose clamp for Ø 60 to 500 mm 	85002397	
<p>HTTA box with SPD</p> <ul style="list-style-type: none"> Screw terminals for 12-wire hybrid cable up to 16 mm² (25 mm²) and 6 power jumper, common power supply circuit 6 surge protection device type 1/2, class I/II 6 LC duplex adapter (single-mode, blue) 6 cable gland for power jumper, 1 cable gland for 6 fiber optic jumper, 1 cable gland for earthing cable Mounting bracket with 2 cable clamps for MLCH Quick hose clamp for Ø 60 to 500 mm 	85098828	

Options:

- 12 LC duplex adapter
- Multimode adapter
- Customised DIN-Rail (screw terminal, circuit breaker, surge protection device)

The hybrid box is designed for flexible configurations (e.g. with surge protection devices), ease and quick deployment of up to 6 remote radio heads. Its innovative design allows for installation using MASTERLINE Classic Hybrid (MLCH), a factory-terminated hybrid cable assembly or MASTERLINE Classic (MLC) bundled fiber and bundled power riser cables.

All power distribution and fiber management components are pre-installed and the robust mounting bracket allows the hybrid cable to be pulled up with the box.

The HTTA box also has the capability to store up to 20 m of fiber cabling (riser or jumper) in its cover and has the option to have connectorised outputs for the ultimate in flexibility..



MASTERLINE Classic Hybrid (MLCH)

Hybrid cable general specifications

		LSFH™ hybrid cable, global market	UL listed hybrid cable, US market
Jacket material		thermoplastic, low smoke, free of halogen (LSFH™)	PVC
Standard		IEC 60502-1:2004-04	UL 1277, TC-OF-ER
Temperature range	in service	-40 to +75 °C	
	installation	-10 to +50 °C	
Operating voltage		48 Vdc	
Rated voltage		0.6 kV/1 kV (1.2 kV)	
Min. bending	during installation	10 × cable Ø	12 × cable Ø
	in service	8 × cable Ø	10 × cable Ø
Cable shielding		copper foil 100 % coverage (contacted with drain wire)	
Halogen free		yes	no
Flame retardant		IEC 60332-1-2:2004	UL 1685 (UL 1581) vertical tray flame test (70 000 BTU/hr)
UV resistant		IEC 60068-2-5	UL1581
CPR compliant		yes, class Dca	no

12-core hybrid cable specification for MLCH 6/6 and MLCH 6/12

	LSFH™ hybrid cable, global market		UL listed hybrid cable, US market	
Number of cross section	12			
Conductor cross section	6 mm ²	10 mm ²	AWG 10	AWG 8
Resistance	3.08 Ω/km	1.83 Ω/km	3.41 Ω/km	2.13 Ω/km
Maximum current rating	25 A	35 A *	16 A	23 A
Outer diameter	27.5 mm	28 mm	25.4 mm (1.00")	30 mm (1.18")
Weight	1.17 kg/m	1.72 kg/m	1.25 kg/m	1.64 kg/m
Drain wire cross section	6 mm ²	10 mm ²	AWG 6	AWG 6
Fiber optic	5 mm loose tube cable with 6 fibers single-mode E9/125 A2 or multimode OM3			

* limitation trough power connector maximum current rating 42 A (IEC) and 44 A (UL)

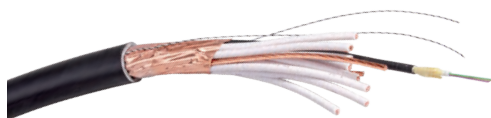

Hybrid cable with 6 pairs power wire and 6 pairs of fiber optic

Hybrid cables of HUBER+SÜHNER combine optical fiber and DC power, are highly flexible and easy-to-route. Two rip cords between the shielding and the jacket allows a quick stripping of the jacket. The shielding, a copper foil under the jacket and the drain wire maintain contact throughout the cable run and allow potential equalisation and a safe installation with regard to lightning strikes.

MASTERLINE Classic Hybrid (MLCH)

Ordering information

MASTERLINE Classic Hybrid for 6 RRHs – MLCH 6/6



	Radio end side	BTS side
Fiber optic	LC uniboot	LC uniboot
Power	blunt cut wire cross section 6 mm ² /AWG 10 or 10 mm ² /AWG 8	blunt cut wire cross section 6 mm ² /AWG 10 or 10 mm ² /AWG 8

Hybrid cable	Market	Length	Item no.		
			6 mm ²	10 mm ²	
6 pairs conductor 6 pairs fiber optic single-mode A9/125 A2	global not UL listed CPR compliant	10 m	85007381		
		20 m	85007382		
		30 m	85007383		
		40 m	85007384		
		50 m	85007385		
		60 m		85007386	
		70 m		85007387	
		80 m		85007388	
		90 m		85007389	
		100 m		85007390	
	US UL listed			AWG 10	AWG 8
		10 m	85007392		
		20 m	85007393		
		30 m	85007394		
		40 m	85007395		
		50 m	85007396		
		60 m		85007397	
		70 m		85007398	
		80 m		85007399	
		90 m		85007400	
100 m		85007401			

Options

- 12 pairs fiber optic single mode A9/125 A2
- 6 or 12 pairs fiber optic multimode OM3
- Other length

MASTERLINE Classic Hybrid (MLCH)

LC duplex RRH jumpers



Features

- Jumper available for all types of remote radios
- Cable diameter 4.8 mm, 5.5 mm or 7 mm
- Standard lengths of 2 m and 5 m, any customised length available

The HTTA box enables the use of 6 RRH jumper cables (optional 12) through 2 cable glands with pre-split sealings. Ordering information see page 66 (MLC).

2-core power jumpers

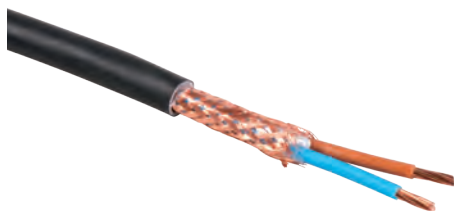





Features

- 2 core copper cable for RRH power supply
- LSFHTM jacket material
- Braided copper shield
- 4, 6 and 10 mm² cross section

Ordering information see page 21 (MLC).

Accessories

Description		Item no.	Page	Picture
Clamps for hybrid cable		depends on cable diameter	134	
Grounding kits		85015070	138	
19" CTB patching box	6, 12, 18 or 24 LC duplex adapter blue	depends on quantity of LC adapter	130	
LC patchcords	0.5 m, 0.7 m or 1 m length, single-mode	depends on length	133	
SFP/SFP+ transceivers for different protocols, data rates and power budgets		see transceiver selection guide on page 260	259	

MASTERLINE Classic Hybrid (MLCH)

Hybrid RRH jumper



Features

- Pre-assembled hybrid jumper with 2 or optional 4 fibers
- Jumper terminated with vendor approved RRH connectors
- Power cable shielded from end-to-end, easy ground connection inside box and at RRH, no additional grounding kits required
- Ruggedised cable design and cable divider
- „Plug & play“ installation – no field termination/wrapping/ preparation necessary

Specifications

Temperature range	-4 0 to +75 °C	
Operating voltage	48 VDC	
Rated voltage	0.6 kV/1 kV	
Fiber (radio end)	FullAXS connector	LC duplex connector
Power (radio end)	blunt-cut	blunt-cut
Fiber (HTTA box)	LC duplex connector	
Power (HTTA box)	blunt-cut	

Portfolio/ordering

Due to the number of variables involved there is no standard portfolio

FullAXS



LC duplex

Compatible to
RRH connector

10 AWG
power pair

LC duplex



LC duplex

10 AWG
power pair

10 AWG
power pair

Please contact HUBER+SUHNER to define your customised product.

- Single-mode or multimode, 2 or 4 fibers
- Cross section of copper wires (2 × 4 mm², 2 × 6 mm², or 2 × 10 mm²)
- Shielded or un-shielded
- Type of fiber optic connectors (ODC, RRH compatible connector, LC)
- Type of power termination (connectorised or open-ended)
- Assembly length (dependent on cross section)
- Breakout length at remote radio



Accessories for remote radio installation solutions

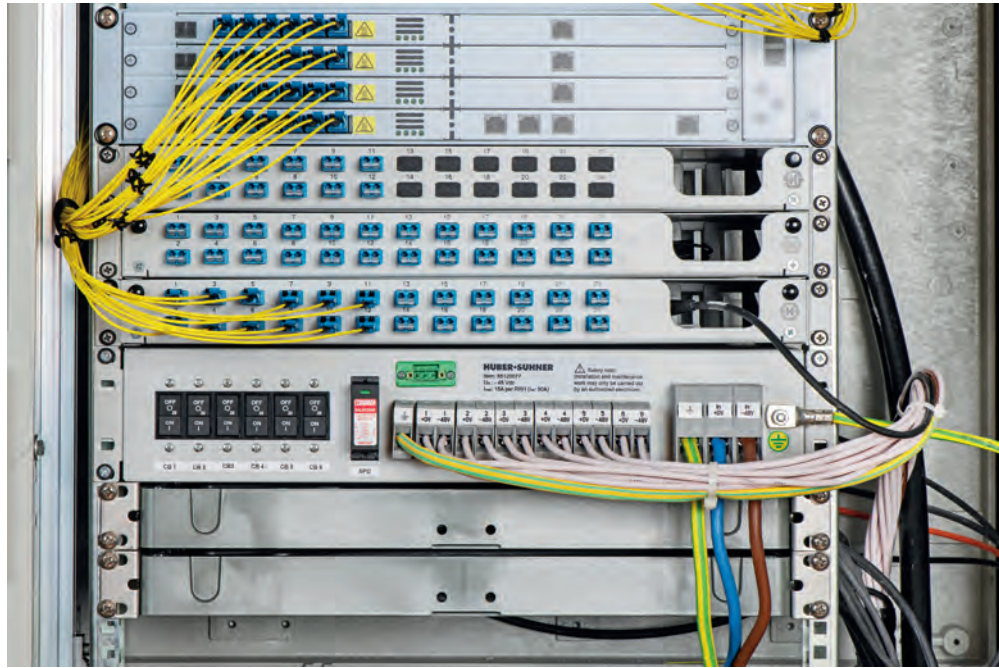

HUBER+SUHNER is an experienced partner for remote radio installation and we are close to the installers working in the field. We understand the daily installation issues and the need for field-proven tools and accessories.

Excess cable boxes help to safely store fiber optic cable at the bottom of the mast or in 19" racks. The 19" CTB patching box with a pullout tray for easy access fits to the MASTERLINE cable system.

19" power distribution units for up to 6 radio heads - each electrical circuit is fused with a circuit breaker - are compatible with MASTERLINE hybrid cabling systems of HUBER+SUHNER.

Further, we offer a basic cable clamp portfolio, which covers most of the RRH installation solutions and cable combinations. The used clamps are field-proven, easy to install and allow for an upgrade or exchange of cables.

We offer a universal grounding kit specially designed to accommodate the range of HUBER+SUHNER power and hybrid cable sizes. Also available is a heavy-duty cable stripping tool.

Accessories

Distribution box



Features

- Outdoor and indoor installation
- Store up to 30 m cable excess length (depending on cable diameter)
- Easily mountable on poles, on walls or in 19" racks (1U)
- Supplied with fixing brackets, screws, a laser warning label and some hook and loop cable ties

Specifications

Dimensions without mounting bracket	477 × 280 × 43.8 mm (1 unit)	
Mandrel radius	60 mm	
Material	glass-filled polycarbonate, halogen-free, UV resistant	
Flammability	UL 94 V0	
Operating temperature	-40 to 75°C	
Cable excess length capacity	cable Ø 4.8 mm	30 m
	cable Ø 7.0 mm	20 m

Ordering information

Description	Item no.
Overlength box	84103325

19" Power distribution unit

19" Power distribution unit for 6 RRH with circuit breaker and surge protection device



Features

- Power distribution unit for 19" racks
- 6 DC-circuits with circuit breaker
- Surge protection device with remote indication contact
- Compatible with MASTERLINE Hybrid and Power cabling systems

Specifications

Number of RRH		6
Dimensions	height	2 units, 87.6 mm
	width incl. brackets	482 mm
	Width w/o brackets	444 mm
	depth	240 / 315 mm
U_N rated voltage		-48 V DC
$I_{IN max}$		120 A (6 × 20 A)
I_N rated current per RRH		20 A
Circuit breaker rating, type		20 A, DD frame , medium delay (code BS) CBI, p/n D2SBXM0063
Surge protection device, type		varistor-based plug-in lightning/surge arrester for L-N protection with remote indication contact Phoenix Contact, type VAL-MS-T1/T2 48/12.5/O-FM (2906282)
Ambient temperature range	operation	-20 to +75 °C
	installation	-10 to +50 °C
Material		powder coated steel
Colour		RAL7035, light grey
Power supply input		3 × screw terminals for maximum 50 mm ² (-48Vdc, 0V, PE)
Power supply output		13 × screw terminals for maximum 16 mm ² (6 × -48Vdc, 6 × 0V, PE)
Protective earth		M6 bolt
Test standards		EN 61439-1

The power distribution unit is compatible with HUBER+SUHNER cabling systems MASTERLINE Ultimate Hybrid/ Power, MASTERLINE Extreme Hybrid / Power and MASTERLINE Classic Hybrid / Power for up to 6 radio heads. Each electrical circuit is fused with a 20A circuit breaker. A varistor-based plug-in lightning/surge arrester T1/T2 between L (-48Vdc) and N (+0V) is used to protect the equipment against surges.



19" patching box

19" power distribution box

Hybrid cable with fiber optic cable and conductors

19" overlength box

HUBER+SUHNER's 19" patching boxes can be used for easy connection with the MASTERLINE cabling systems fiber optic connectors. Up to 30 m fiber optic cables can be stored with 19" overlength box of HUBER+SUHNER.

19" Power distribution unit

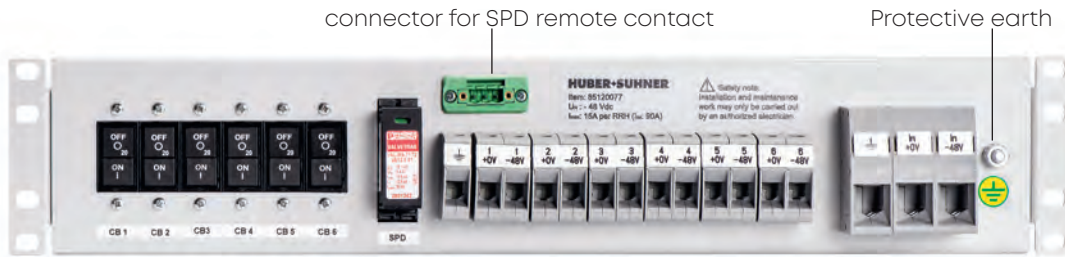

Circuit breaker 20 A 1..6

MLUH, MLUP, MLEH or MLEP

Power input up to 50 mm²

GND/PE
 RRH 1, +0V / -48Vdc
 RRH 2, +0V / -48Vdc
 RRH 3, +0V / -48Vdc
 RRH 4, +0V / -48Vdc
 RRH 5, +0V / -48Vdc
 RRH 6, +0V / -48Vdc

The chassis bracket can be mounted in 2 different positions, aligned with the front panel or 75 mm further ahead.

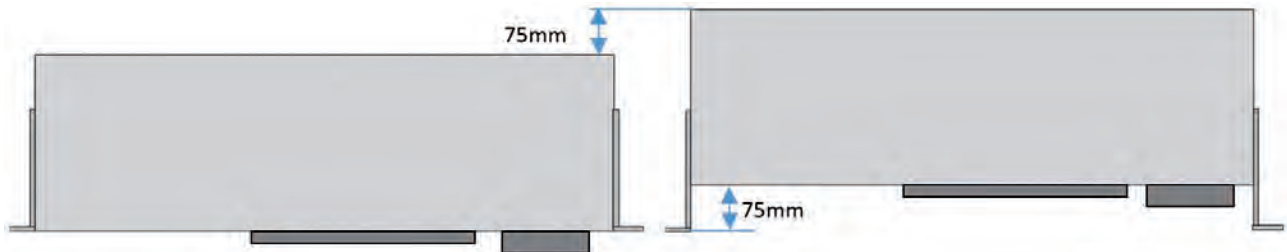

Ordering information distribution box

Description	Item no.
19" Power distribution unit for 6 RRH with 1 surge protection devices and 6 circuit breaker 20 A 19INPDU26-620-13	85120077

Customised configurations on request.

Accessories

19" CTB patching box



Features

- Space saving 19" rack installation
- Cable entry from the front and back for up to 3 MASTERLINE cable systems
- Pullout tray for easy access
- Fitted with 6, 12, 18 or 24 LC duplex adapter
- 3 mandrels for overlength management of the MASTERLINE cable system
- Optional patchcord guide available

Specifications

Dimensions (W × D × H)	482 × 209 × 43.5 mm (1 unit)
Connectivity	6, 12, 18 or 24 LC duplex adapter blue
Cable entry front or back	3 × MASTERLINE Classic 12 fiber or 24 fiber (small divider) 1 × MASTERLINE Classic 36 fiber (medium divider)
Material	powder coated steel
Weight	3 kg
Colour	RAL 7035 light grey

Installation features

Back or front cable entry		
Pullout tray for easy access		
Fixation of the divider, front or back entry		
Patchcord guide optional available		

Accessories

Ordering information

Description	Item no.	Picture
19" patching box 6 LC duplex adapter blue 18 blind caps extendible to 24 LC duplex adapter	85028405	
19" patching box 12 LC duplex adapter blue 12 blind caps extendible to 24 LC duplex adapter	85028406	
19" patching box 18 LC duplex adapter blue 6 blind caps extendible to 24 LC duplex adapter	85028407	
19" patching box 24 LC duplex adapter blue	85028408	
Patchcord guide Including 3 screws and nuts for mounting with the 19" CTB patching box	84125960	

Multimode available on request.

Accessories

19" CTB splicing box







Features

- Space saving 19" rack installation
- Splice cassette for 24 fibers
- Including 24 LC single-mode PC pigtails
- Fitted with 12 LC duplex adapter
- Cable entry from the front and back for MASTERLINE cable systems
- Pullout tray for easy access
- Optional patchcord guide available

Specifications



Dimensions (W × D × H)	482 × 209 × 43.5 mm (1 unit)
Connectivity	12 LC duplex adapter blue
Splice cassette	24 fiber
Pigtails	24 LC single-mode PC
Cable entry front or back	2 × MASTERLINE Classic 12 fiber or 1 × MASTERLINE Classic 24 fiber
Material	powder coated steel
Weight	3 kg
Colour	RAL 7035 light grey

Installation features

Pullout tray for easy access		
Fixation of the divider, front or back entry		
Patchcord guide optional available		

Accessories

Ordering information

Description	Item no.	Picture
19" splicing box including: <ul style="list-style-type: none"> splice cassette for 24 fibers 24 LC single-mode PC pigtails 12 LC duplex adapter blue 12 blind caps 	85028409	
Patchcord guide Including 3 screws and nuts for mounting with the 19" CTB splicing box	84125960	

Multimode available on request.

LC-HQ uniboot patchcord

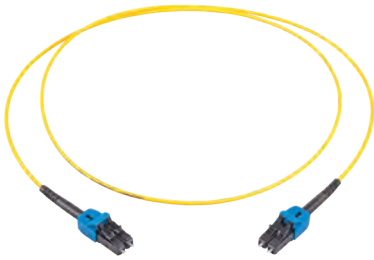

Features

- LC-HQ uniboot patchcord to connect 19" CTB to active equipment (base station)
- Robust 2.1 mm cable
- Polarity flipping without tool

Specifications

Compliance	IEC 61754-20, TIA 604-10-A
Operating temperature	-25 to 70 °C
Mechanical resistance tensile load	70 N
Flammability	UL 94 V-0

Ordering information

Description	Cable and fiber type	Length	Item no.
LC uniboot patchcord	single-mode A2 2.1 mm yellow	0.5 m	84138001
		0.7 m	84125518
		1.0 m	84125519
		1.5 m	84138003
		2.0 m	84141892
	multimode OM 3 2.1 mm turquoise	0.5 m	84138007
0.7 m		84125520	
1.0 m		84125521	

Accessories

Combined cable clamps for fiber optic and power cables



Features

- Combined cable clamps for 1 or 3 pairs of fiber optic and power feeders
- Easy and quick installation
- Stainless steel bracket
- Double saddle with rubber cushions

Specifications

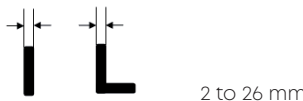
Mounting profile	
Threaded bar M8	installation with 13 mm hex wrench and torque 6 to 8 Nm
Salt mist, IEC 61300-2-26	168 h
Material bracket	stainless steel AISI 304
Material saddle	polypropylene, UV resistant
Material cushions	black rubber

Dimensions

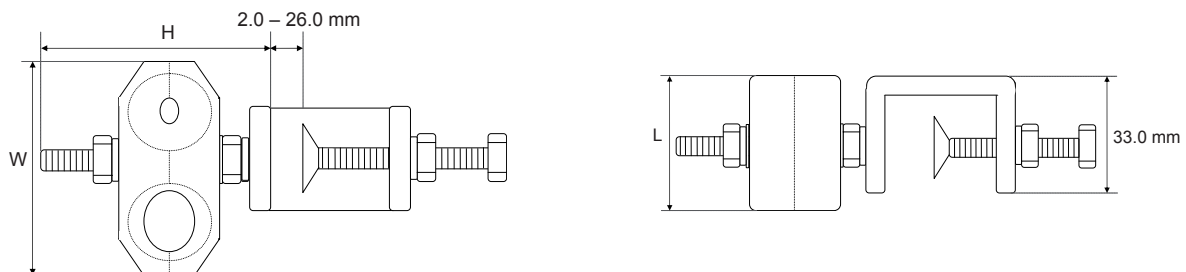

Ordering information

No. of cable pairs	Diameter range fiber optic cable	Diameter range power cable	Dimensions H × W × L	Item no.
1	4.8 to 7.0 mm	10.0 to 13.0 mm	70 × 53 × 40 mm	85011985
		13.0 to 16.0 mm		85012013
3	4.8 to 7.0 mm	10.0 to 13.0 mm	130 × 53 × 40 mm	85011986
		13.0 to 16.0 mm		85012014
1	5.5 to 7.0 mm	17.5 to 20.0 mm	85 × 91 × 50 mm	85012007
		20.5 to 23.0 mm		85012005
		23.5 to 26.5 mm	90 × 65 × 50 mm	85142813
		27.0 to 28.0 mm		85142812
		30.5 to 33.5 mm		85142814
3	20.5 to 23.0 mm	20.5 to 23.0 mm	175 × 91 × 50 mm	85066072
		27.0 to 29.0 mm		85028293

Accessories

Combined cable clamps for fiber optic and power cables



Features

- Combined cable clamp for 2 (3) fiber optic and 1 power cable
- Suitable for C section 40 × 22, flat and round profiles (3-12 mm)
- Stainless steel bracket

Specifications

Mounting profile		
Salt mist, IEC 61300-2-26		672 h (28 d)
Material bracket		stainless steel AISI 304
Material saddle		polyamide, UV resistant
Temperature range	in service	-40°C to 75 °C
	during installation	-10°C to 50 °C

Dimensions

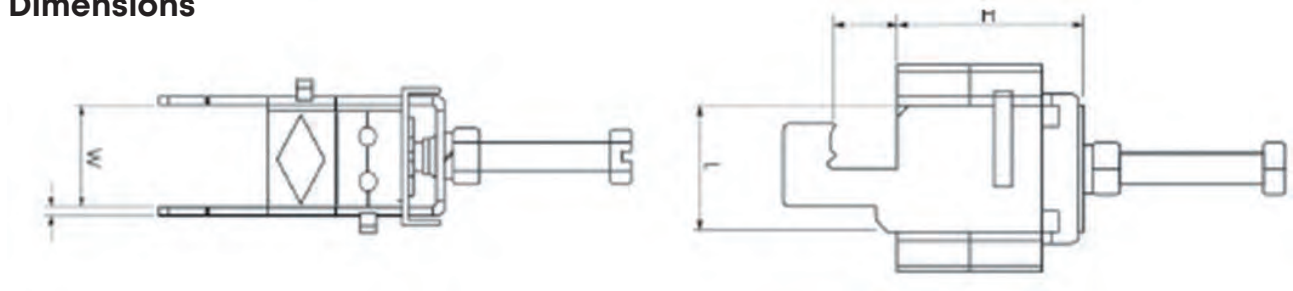

Specifications

Number of power cables	Power cable diameter range	Number of fiber cable	Fiber cable diameter range	Dimensions H × W × L	Packaging quantity	HUBER+SUHNER item no.	
1	15 to 34 mm	2	6 to 7 mm	88 × 35 × 46	5 pcs	85119795	
	18 to 45 mm	3		88 × 46 × 46	5 pcs	85126122	

Accessories

Cable clamps for power and hybrid cables



Features

- Cable clamp for power and hybrid cables
- Easy and quick installation
- Stainless steel bracket
- Standard size without rubber cushion

Specifications

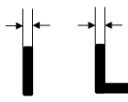
Mounting profile	 2 to 26 mm
Threaded bar M8	installation with 13 mm hex wrench and torque 6 to 8 Nm
Salt mist, IEC 61300-2-26	168 h
Material bracket	stainless steel AISI 304
Material saddle	polypropylene, UV resistant
Material cushions	black rubber

Dimensions

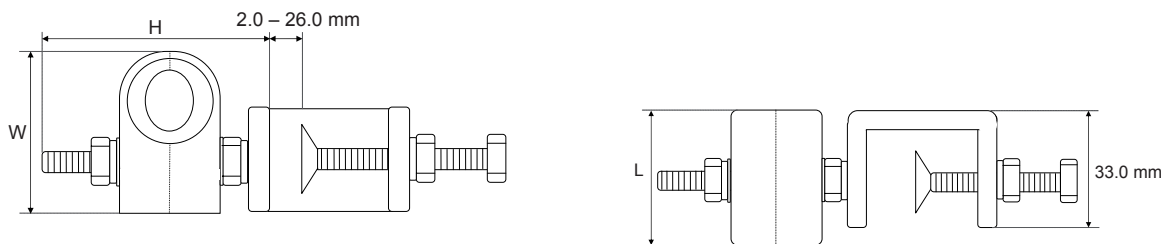

Ordering information

No. of cable	Cable diameter range	Dimensions H × W × L	Item no.
1	21.0 to 23.0 mm (5/8")	180 × 38 × 46 mm	85015525
	23.0 to 25.0 mm	100 × 51 × 55 mm	85065434
	27.0 to 29.0 mm (7/8")		85013128
	30.0 to 32.0 mm		120 × 76 × 59 mm
	32.0 to 34.5mm	85014015	
	35.0 to 37.0mm	85065435	
	37.0 to 40.0mm (1 1/4")	85014016	
3	18.2 to 22.00 mm	175 × 55 × 51 mm	85012939

Accessories

Cable clamps for power and hybrid cables



Features

- Cable clamp for power and hybrid cable
- Suitable for C section rail 40 × 22
- Stainless steel bracket

Specifications

Mounting profile	<p>C section rail 40 × 22</p> <p>3 to 12 mm</p>
Salt mist, IEC 61300-2-26	720 h
Material bracket	stainless steel AISI 304
Material saddle	polyamide

Dimensions

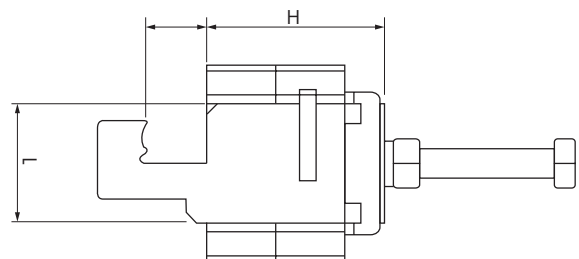
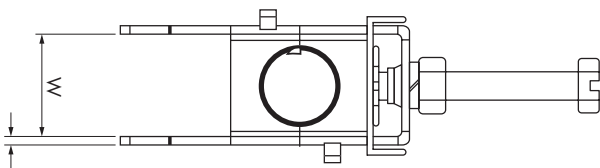

Ordering information

No. of cable	Cable diameter range	Dimensions H × W × L	Item no.
1	21.0 to 23.0 mm (5/8")	46 x 34 x 25 mm	85085150
	23.0 to 25.0 mm	46 x 34 x 25 mm	85085154
	27.0 to 29.0 mm (7/8")	46 x 34 x 25 mm	85085159
	30.0 to 32.0 mm	60 x 46 x 25 mm	85085161
	32.0 to 34.0 mm	60 x 46 x 25 mm	85085162
	35.0 to 37.0 mm	60 x 46 x 25 mm	85085163
	38.0 to 40.0 mm (1 1/4")	60 x 46 x 25 mm	85085164

Accessories

Grounding kit for hybrid cables



Features

- Universal grounding kit for hybrid cables
- Cable diameter range 16 mm to 40 mm
- 0.5 m long grounding wire 16 mm²
- Tin plated copper lug for M8 screw

The universal grounding kit is specially designed to accommodate the range of HUBER+SÜHNER hybrid cable sizes. The tinned copper strap and associated hardware facilitates a proper attachment to the braided screen or copper foil. The 16 mm² (AWG 6), stranded copper wire with a one-hole lug (Ø 8.5 mm) provides a low inductance transfer of lightning induced current from the hybrid cable to the system ground. Installation of grounding kits is recommended at the top and bottom of each vertical run, at 20 m (66 ft) increments and just prior to building entry.

Specifications

Typical contact transition resistance	1 mΩ
Current handling capability (10/350 μs)	25 kA
Ingress protection	IP67
Ambient temperature range	-40 to 75 °C

Installation features

<p>List of components</p> <ul style="list-style-type: none"> • Tinned copper strap assembly with 0.5 m grounding wire and one-hole lug (Ø 8.5 mm) • 50.8 mm × 6.1 m (2" × 20") roll electrical tape (PVC) • 63.5 mm × 0.4 m (2-1/2" × 15") roll butyl mastic • Coiling tool • Installation manual 	
<p>The ground strap is wrapped around the exposed screen. The end of the strap has to be pulled through the slot at the strap. With the attached coiling tool the strap has to be tightened. There is an expansion joint at the strap which provides a visual indication if the strap is tightened enough. Note: H+S recommend to use the adjustable heavy-duty cable stripping tool with H+S item no. 85029959.</p>	
<p>Butyl mastic is placed around the clamp and acts as a filler. The vinyl electrical tape is wrapped around the hole ground strap to make it waterproof.</p>	

Ordering information

Description	Item no.
Universal grounding kit for hybrid cables	85015070

Accessories

Grounding cable



Features

- Flexible single core grounding cable
- RADOX 125 jacket material with excellent outdoor characteristics
- Stranded tin plated copper conductor
- M8 lugs on both ends
- Available in both black or yellow/green colours

HUBER+SUHNER grounding cables with RADOX 125 (electron beam crosslinked polyolefin copolymer) jacket and M8 lugs on both ends fits onto the integral earth stud of MLEP, MLEH, MLUP and MLUH cabling systems.



Specifications

Conductor	stranded tin plated copper, class 5 acc. to EN 60228
Jacket material	electron beam crosslinked polyolefin copolymer
Ambient temperature range	-40 to 75°C
Rated Voltage U0/U	600 V/1000 Vac
Test voltage	3500 Vac
Halogen-free	acc. EN 50363
Lug type	tubular standard cable lug
Size of bolt diameter	M8
Lug material	tin-plated copper acc. to EN 13600
Vibration	acc. DIN EN 61373 class 1 B

Ordering information



Cable cross section	Cable length	Cable colour	Size of bolt diameter left side	Size of bolt diameter right side	Item no.
16 mm ²	0.5 m	black	M8	M8	85086667
16 mm ²	0.5 m	yellow/green	M8	M8	85083781
25 mm ²	0.5 m	black	M8	M8	85086668
25 mm ²	0.5 m	yellow/green	M8	M8	85083792

Options:

- Other length
- Other lugs (e.g. angled, dual hole)

Accessories

Heavy-duty cable stripping tool for power and hybrid cable

Adjustable heavy-duty cable stripping tool Wire size: 4.5 to 40 mm/0.18" to 1.57" Stripping dimensions adjustable up to 4.5 mm/0.18" insulation thickness	85029959	
Spare blade for adjustable heavy-duty cable stripping tool (85029959)	85032058	

MLEP/MLEH mounting bracket



mounting bracket
MLEH small

mounting bracket
MLEH large

Features



- Quick and easy to install
- Robust stainless steel bracket
- UV resistant plastic clip with snap-in mechanism
- Clip can be closed without tool
- Suitable for poles and walls

The MLEP/MLEH mounting bracket has a snap-in mechanism for quick and easy fixation of the divider housing. The clips are UV resistant can be closed by hand without any tool. With a medium size screw drive the clip can be reopened at any time.

Specifications

Bracket material	stainless steel	
Plastic clip	PA12 black	
Dimension W x H x D	mounting bracket MLEH small	159 mm x 122 mm x 89 mm
	mounting bracket MLEH large	159 mm x 164 mm x 89 mm

Ordering information

Description	Item no.	
Mounting bracket with 2 clips for MLEP/MLEH small	85140742	
Mounting bracket with 1 double clip for MLEP/MLEH large	85140743	

Quick hose clamp



Features

- Stainless steel
- Diameter 40 to 160 mm or 60 to 500 mm

Specifications

Material	stainless steel 304	
Material thickness	0.65 mm	
Dimension width	14.2 mm	
Dimension range	30 to 155 mm/60 to 500 mm	

Ordering information

Description		Item no.
Quick hose clamp One set including 2 pieces	diameter range 30 to 155 mm	84076411
	diameter range 60 to 500 mm	84076412



Fiber optic interfaces for remote radio heads



HUBER+SUHNER is the leading supplier of harsh environment fiber optic interfaces for remote radio heads. RRH are installed in many different types of environments such as coastal areas, urban buildings or rural tower sites and extreme temperatures, vibration, salt mist, corrosive gases and humidity are all typical challenges. Therefore robustness and reliability are crucial for the design of RRH interfaces. Additionally, the interface needs to be safe to install and must not cause any installation errors – this is essential to compensate for unskilled installers.

Damage to fiber optic interfaces is the number one cause of defects during RRH installation. Innovation and field-experience enables HUBER+SUHNER to design leading RRH interfaces like ODC and Q-ODC.

Q-ODC-2 Mini – smallest fiber optic connector for harsh environments

Fiber optic products manufactured by HUBER+SUHNER are suitable for complex applications with very high data rates and are constantly being further developed. HUBER+SUHNER is now expanding the connector portfolio with the Q-ODC-2 Mini. The size optimised connector with two fibers is used in especially harsh environmental conditions. Even when installation has to be fast and safe, this smallest fiber optic interface is the ideal solution for applications in communication and industrial market.

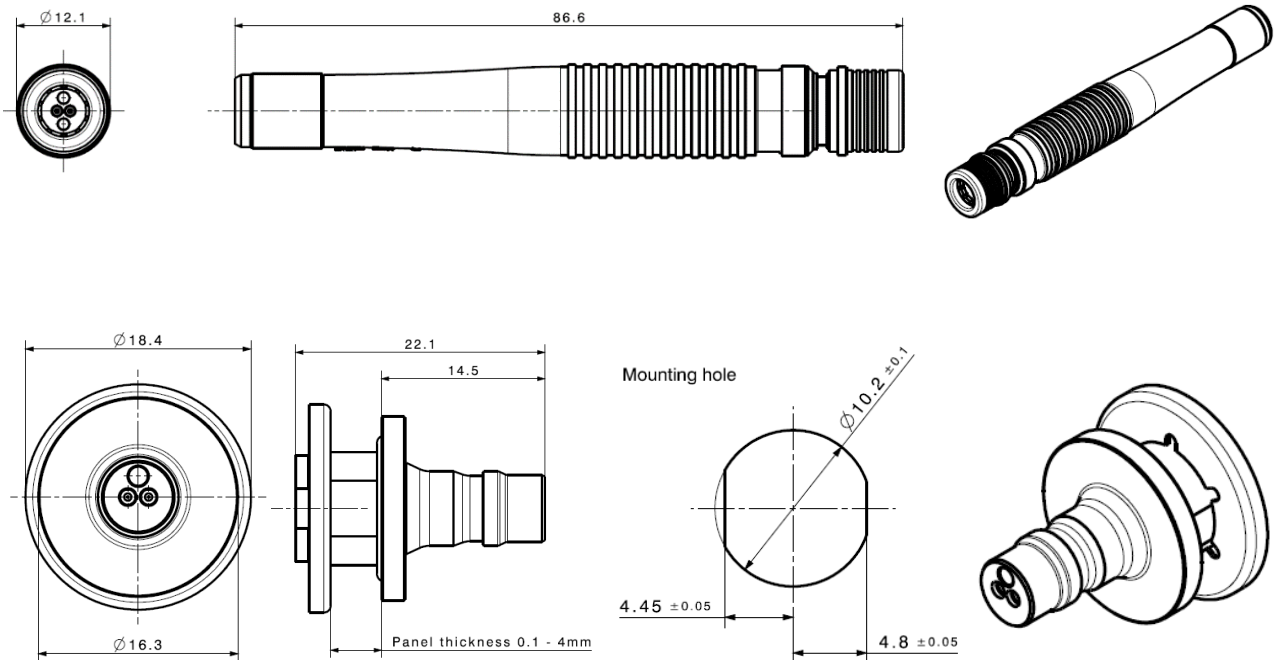

Fiber optic interfaces for remote radio heads

Harsh environment connectors Q-ODC-2 Mini



Features

- 2 fibers, single-mode or multimode
- Compact design with 2 × 1.25 mm ferrules
- Size optimised built-in socket
- Extension connector for cable chaining
- Robust push-pull coupling mechanism – two clearly defined mating states
- Highest outdoor installation safety
- Waterproof, dust proof and corrosion resistant
- Waterproof protection caps available
- EMI protected
- RoHs compliant

Specifications

Characteristics	Tested acc. to	Values
Technology		full ceramic ferrule and sleeve
Housing material		nickel-plated brass
Mating mechanism		push-pull with two clearly defined states
Mechanical performance	Q-ODC plug	≤ 150 N tensile load
Operating temperature ¹⁾	IEC 61300-2-22	-40 up to +85 °C
Mating durability	IEC 61300-2-2	50 cycles ²⁾
Ingress protection (mated)	IEC 60529	IP68
Salt mist	IEC 61300-2-26	30 days passed
Vibration	IEC 61300-2-1	passed 10 to 500 Hz/10 g
	IEC 61373	passed category 1A/B, 2, 3
Shock	IEC 61300-2-9	passed 50 g
	IEC 61373	passed category 1, 2

¹⁾ depending on cable type, ²⁾ with repeated cleaning

Optical performance

Characteristics	Conditions	Tested acc. to	Values
Insertion loss/IEC 61300-3-34	single-mode	typ. ≤ 0.20 dB	97 % ≤ 0.45 dB
	multimode	typ. ≤ 0.20 dB	97 % ≤ 0.50 dB
Return loss	single-mode	≥ 50 dB	

Fiber optic interfaces for remote radio heads

Harsh environment connectors Q-ODC-2



Features

- 2 fibers, singlemode or multimode
- Compact design with 2 x 1.25 mm ferrules
- Extension connector for cable chaining
- Robust push-pull coupling mechanism – two clearly defined mating states
- Highest outdoor installation safety
- Waterproof, dust proof and corrosion resistant
- Waterproof protection caps available
- EMI protected
- RoHs compliant
- Fulfills performance standard IEC 61753-1 Cat. E

Specifications

Characteristics	Tested acc. to	Values
Technology		full ceramic ferrule and sleeve
Housing material		nickel-plated brass
Mating mechanism		push-pull with two clearly defined states
Mechanical performance	Q-ODC plug	≤ 450 N tensile load ≤ 3 N static side load
	Q-ODC socket	≤ 30 N static side load
Operating temperature ¹⁾	IEC 61300-2-22	-40 up to +85 °C
Mating durability	IEC 61300-2-2	200 cycles ²⁾
Ingress protection (mated)	IEC 60529	IP68 (30 days/3 m)
Salt mist	IEC 61300-2-26	30 days passed
Vibration	IEC 61300-2-1	passed 10 to 500 Hz/10 g
	IEC 61373	passed category 1A/B, 2, 3
Shock	IEC 61300-2-9	passed 50 g
	IEC 61373	passed category 1, 2

¹⁾ depending on cable type, ²⁾ with repeated cleaning

Optical performance

Characteristics	Conditions	Tested acc. to	Values
Insertion loss singlemode	typ. ≤ 0.20 dB	IEC 61300-3-34	97 % ≤ 0.45 dB
Insertion loss multimode	typ. ≤ 0.20 dB	IEC 61300-3-34	97 % ≤ 0.50 dB
Return loss	≥ 50 dB	≥ 50 dB	0.30

Mating/unmating sequences



Push plug connector slightly into extension connector, rotate to find keying position, push connector to mate.



Mated – connector snaps in and is fully strain relieved.



Pull coupling ring to unmate.

Fiber optic interfaces for remote radio heads

Harsh environment connectors Q-ODC-2 plug/socket

Overview of Q-ODC-2 connector types

Type new	Connector	Dust cap
QOP5	Q-ODC-2 plug 	push-on IP67 
QOP6		push-on IP67 
QOE5	Q-ODC-2 extension 	push-on IP67 
QOE6		push-on IP67 
QOS1	Q-ODC-2 socket square 	push-on IP67 
QOS2		push-on IP67 
QOS3		snap-on IP67 
QOS4		snap-on with chain IP67 
QOR1	Q-ODC-2 socket hexagonal 	push-on IP67 
QOR2		push-on IP67 
QOR3		snap-on IP67 
QOR4		snap-on with chain IP67 

Q-ODC – push-pull connector for modular cell site installations

Q-ODC is used by a growing number of operators who build a modular and flexible cell site cable infrastructure. The push-pull connectors allows for quick and reliable cable connections, e.g. for top-mast boxes or jumpers. Additionally, the interface is designed that it is either mated or unmated – nothing in between. This makes each installation of cell site infrastructure safe.



Fiber optic interfaces for remote radio heads

Q-ODC-12 / Q-ODC-24 outdoor connector



Features

- Up to 24 fibers, single-mode or multimode
- Compact design with MT ferrules
- Built-in socket with square flange/hexagonal flange
- Extension connector for cable chaining
- Robust push-pull coupling mechanism – two clearly defined mating states
- Highest outdoor installation safety
- Waterproof, dust proof and corrosion resistant
- Waterproof protection caps available
- RoHs compliant

Specifications

Technology		plastic ferrule (PPS)
Housing material		nickel-plated brass
Mating mechanism		push-pull with two clearly defined states
Mechanical performance	Q-ODC plug	≤ 500 N tensile load ≤ 30 N static side load
	Q-ODC socket	≤ 30 N tensile load
Operating temperature ¹⁾	IEC 61300-2-22	-40 up to +85 °C
Mating durability	IEC 61300-2-2	100 cycles ²⁾
Ingress protection (mated)	IEC 60529	IP68 (3 m/30 days)
Salt mist	IEC 61300-2-26	30 days passed
Vibration	IEC 61300-2-1	passed 10 to 500 Hz/10 g
Shock	IEC 61300-2-9	passed 50 g
	IEC 61373	passed category 1, 2

¹⁾ depending on cable type, ²⁾ with repeated cleaning

Optical performance – MTP performance by fiber type/grade

Fiber type/grade	Typical IL (dB)	Maximum IL (dB)
Low-loss single-mode (SM MT Elite)	0.15	0.35
Low-loss multimode (MM MT Elite)	0.15	0.35

Mating/unmating sequences



Push plug connector slightly into extension connector, rotate to find keying position, push connector to mate. Use arrows on a boot for pre-alignment.



Mated – connector snaps in and is fully strain-relieved.























Pull coupling ring to unmate.

Fiber optic interfaces for remote radio heads

Q-ODC-12 / Q-ODC-24 outdoor connector

Overview of Q-ODC connector types (Connector code for Q-ODC-12 and Q-ODC-24 is equal. Differentiation will be done with assembly code).

Type	Type new	Connector	Dust cap		
QX	QOP1	 Q-ODC-12 / Q-ODC-24 plug	push-on	IP67	
	QOP2		push-on	IP67	
	QOP3		snap-on	IP67	
	QOP4		snap-on with chain	IP67	
QY	QOE1	 Q-ODC-12 / Q-ODC-24 extension	push-on	IP67	
	QOE2		push-on	IP67	
	QOE3		snap-on	IP67	
	QOE4		snap-on with chain	IP67	
QZ	QOS1	 Q-ODC-12 / Q-ODC-24 socket square	push-on	IP67	
	QOS2		push-on	IP67	
	QOS3		snap-on	IP67	
	QOS4		snap-on with chain	IP67	
QW	QOR1	 Q-ODC-12 / Q-ODC-24 socket hexagonal, mounted from the rear, simplex cable	push-on	IP67	
	QOR2		push-on	IP67	
	QOR3		snap-on	IP67	
	QOR4		snap-on with chain	IP67	

Fiber optic interfaces for remote radio heads

ODC[®]-2 outdoor connector



Features

- 2 fibers, single-mode or multimode
- Compact design with 2 x 1.25 mm ferrules
- Built-in socket with square or hexagonal flange
- Extension connector for cable chaining
- Screwed locking mechanism
- Easy and safe installation
- Waterproof, dust proof and corrosion resistant
- Waterproof protection caps
- EMI protected
- RoHs compliant
- Full compatibility with previous version
- Fulfills performance standard IEC 61753-1 Cat. E

Specifications

Technology		full ceramic ferrule and sleeve
Housing material		nickel-plated brass
Mating mechanism		push-pull with two clearly defined states
Mechanical performance	ODC-2 plug	≤ 800 N tensile load
	ODC-2 socket	≤ 30 N tensile load
Installation torque force	min. 1 Nm	max. 2 Nm
Operating temperature ¹⁾	IEC 61300-2-22	-40 up to +85 °C
Mating durability		1000 cycles ²⁾
Ingress protection (mated)	IEC 60529	IP68
Salt mist	IEC 61300-2-26	30 days passed
Vibration	IEC 61300-2-1	passed 10 to 500 Hz/10 g
Shock	IEC 61300-2-9	passed 50 g

¹⁾ depending on cable type, ²⁾ with repeated cleaning

Optical performance

Insertion loss IEC 61300-3-34	single-mode	typ. ≤ 0.20 dB	97 % ≤ 0.45 dB
	multimode	typ. ≤ 0.20 dB	97 % ≤ 0.50 dB
Return loss	single-mode	≥ 50 dB	

Fiber optic interfaces for remote radio heads

ODC[®]-2 outdoor connector

Overview of ODC-2 connector types

Type	Type new	Connector	Dust cap	
A1	ODP1	ODC-2 plug 	screwed cap with pulling feature	IP68 
A4	ODP2		screwed cap with chain	IP68 
E1	ODE1	ODC-2 extension (socket type) 	screwed cap	IP68 
E3	ODE2		screwed cap with chain	IP68 
C1	ODS1	ODC-2 socket, square small 	screwed cap	IP68 
C3	ODS2		screwed cap with chain	IP68 
B3	ODR1	ODC-2 socket, hexagonal, mounted from rear 	screwed cap	IP68 
B4	ODR2		screwed cap with chain	IP68 

ODC – worldwide the most often installed remote radio interface

We believe there is no country in the world in which ODC assemblies have not been installed yet. There is no other RRH interface which is used more often and which was chosen by more system vendors.

The success comes from the fact that ODC is an extremely robust outdoor connector which withstands all installation hazards – and most importantly – does not permit handling errors. ODC makes mobile networks more reliable and guarantees 100 % performance.



Fiber optic interfaces for remote radio heads

ODC[®]-4 outdoor connector



Features

- 4 fibers, single-mode or multimode
- Compact design with 4 × 1.25 mm ferrules
- Built-in socket with square or hexagonal flange
- Extension connector for cable chaining
- Screwed locking mechanism
- Easy and safe installation
- Waterproof, dust proof and corrosion resistant
- Waterproof protection caps
- EMI protected
- RoHs compliant
- Full compatibility with previous version
- Fulfills performance standard IEC 61753-1 Cat. E

Specifications

Technology		full ceramic ferrule and sleeve
Housing material		nickel-plated brass
Mechanical performance	ODC-4 plug	≤ 800 N tensile load
	ODC-4 socket	≤ 30 N static side load
Installation torque force	min. 1 Nm	max. 2 Nm
Operating temperature ¹⁾	IEC 61300-2-22	-40 up to +85 °C
Mating durability		1000 cycles ²⁾
Ingress protection (mated)	IEC 60529	IP68
Salt mist	IEC 61300-2-26	30 days passed
Vibration	IEC 61300-2-1	passed 10 to 500 Hz/10 g
Shock	IEC 61300-2-9	passed 50 g

¹⁾ depending on cable type, ²⁾ with repeated cleaning

Optical performance

Insertion loss IEC 61300-3-34	single-mode	typ. ≤ 0.20 dB	97 % ≤ 0.45 dB
	multimode	typ. ≤ 0.20 dB	97 % ≤ 0.50 dB
Return loss	single-mode	≥ 50 dB	

Fiber optic interfaces for remote radio heads

ODC®-4 outdoor connector

Overview of ODC-4 connector types

Type	Type new	Connector	Dust cap	
J2	ODP1	ODC-4 plug 	screwed cap with pulling feature	IP68 
J3	ODP2		screwed cap with chain	IP68 
E4	ODE1	ODC-4 extension (socket type) 	screwed cap	IP68 
E6	ODE2		screwed cap with chain	IP68 
K2	ODR1	ODC-4 socket, hexagonal 	screwed cap	IP68 
K3	ODR2		screwed cap with chain	IP68 
K6	ODS1	ODC-4 socket, square small 	screwed cap	IP68 
K7	ODS2		screwed cap with chain	IP68 

Fiber optic interfaces for remote radio heads

Q-XCO – quick-lock ruggedised SFP connector



Features

- Quick-lock mating connector for remote radio head and industrial applications
- Ruggedised outdoor design with 2 × LC interface
- Plugs directly into SFP module, compatible with all standard SFP modules
- Full compensation of positioning tolerances and SFP module tolerances
- Bayonet, blind-mating mechanism and highest installation safety
- Full protection of optical interface during installation
- Access and exchange of SFP module possible
- RoHs compliant

Mating mechanism

Mating	1-step blind mating	bayonet
	mating references	visual and latch
Compensation of positioning tolerances of SFP module	z-axis	± 2.25 mm
	x, y-axis	± 0.4 mm (± 0.6 mm depending on SFP module)
Latching of LC connector	use of LC HQ technology	automating latching and unlatching
Mating durability	IEC 61300-2-2	100 cycles
Force on SFP module		no force in mated state

Specification

Technology		LC full ceramic ferrules	
Housing material	connector	high-performance plastic	
	socket	die-casting with zinc plating	
Material flammability rating		UL 94-V0	
Mechanical performance	IEC 61300-2-4	≤ 400 N tensile load	
	IEC 61300-2-42	≤ 30 N static side load	
	IEC 61300-2-5	180° cable torsion, passed	
Thermal performance	operation, IEC 61300-2-22	-40 to +85 °C	
	installation	-40 to +55 °C	
Ingress protection	IEC 60529-20	IP67 (mated or with dust cap)	
Salt mist	84108683	IEC 61300-2-26, MIL-STD-202G Method 101E	192 h
	85006151	IEC 61300-2-26	720 h
Vibration	IEC 61300-2-1, MIL-STD-202G, Method 204G	passed 10 to 500 Hz/10 g	
Shock	IEC 61300-3-3, MIL-STD-202G, Method 213B	passed 50 g	
UV resistance	ISO 4982-2	passed 2000 h at 2000 MJ/m ²	

Optical performance

Insertion loss	single-mode	typ. ≤ 0.20 dB	97 % ≤ 0.45 dB
	multimode	typ. ≤ 0.20 dB	97 % ≤ 0.50 dB
Return loss	single-mode	≥ 50 dB	

Fiber optic interfaces for remote radio heads





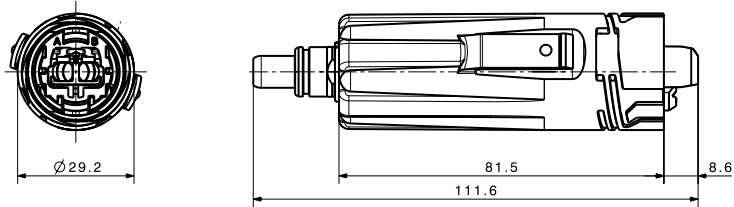

Q-XCO – quick-lock ruggedised SFP connector

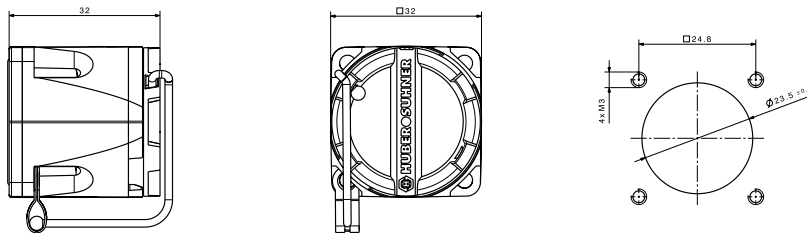
Q-XCO plug



Q-XCO flange small



Type	Type new	Connector	Dust cap
XA	QXP2	Q-XCO connector 	IP67 
Item no. 84108683		Q-XCO flange small 	IP67 
Item no. 85006151		Q-XCO flange small e-coating 	IP67 

Fiber optic interfaces for remote radio heads

Q-XCO – quick-lock ruggedised SFP connector

Tolerance compensation

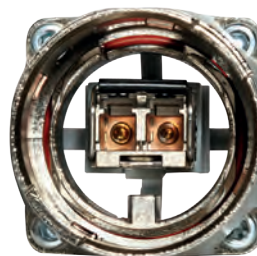

The connector compensates for all tolerances of SFP modules and for mounting tolerances



Exchange of SFP module. Release and pull SFP module

Mating/unmating sequences



Rotate to find correct keying position.



Slide connector into flange and rotate 155° until snap-in position



Connector mated with visual reference for correct installation

Installation safety for LTE and microwave links

Q-XCO is the most installation safe fiber optic interface on the market. The connector is designed for harsh outdoor applications and for installation in challenging environments such as high up on radio masts under any atmospheric condition. Its „one-hand“ blind mating performance in combination with full SFP tolerance compensation makes this connector the best in its class.

For that reason, leading system vendors have chosen Q-XCO as the fiber optic interface for LTE remote radios and for state-of-the-art microwave backhaul systems – simply to have better connections.

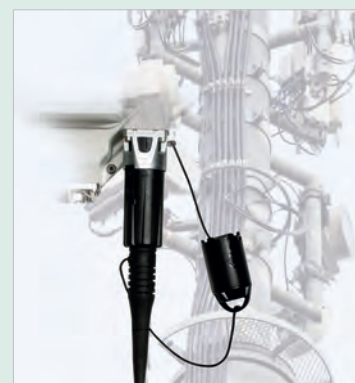

Fiber optic interfaces for remote radio heads

Q-XCO – quick-lock ruggedised SFP connector

SFP cage positioning specification

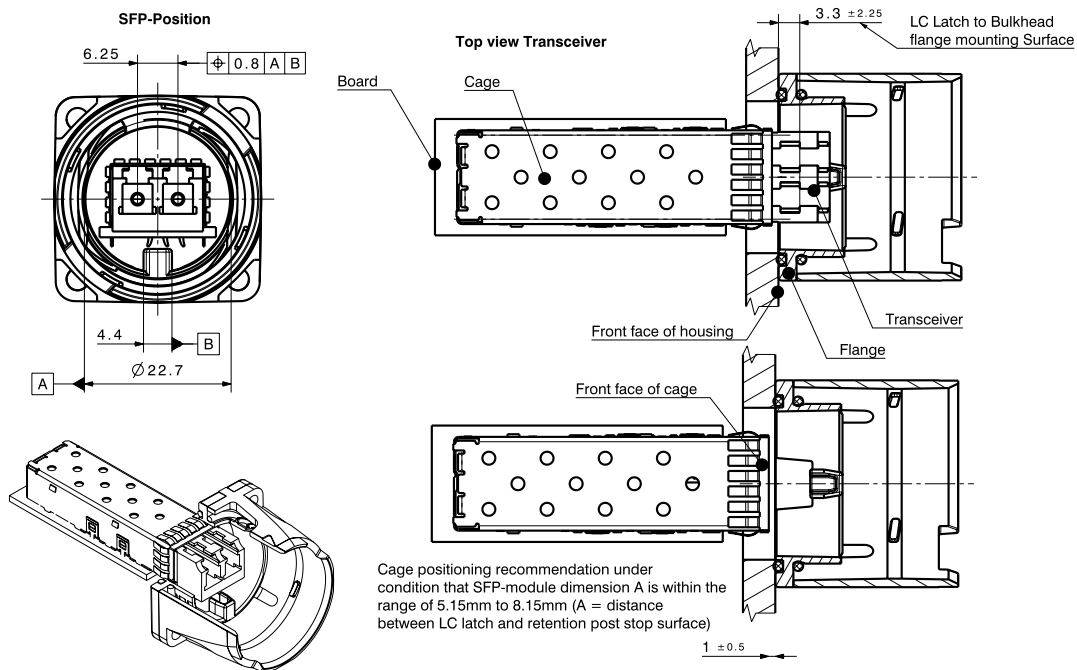

Module width and height extending outside of cage, see SFF-8432 Specification for Improved Pluggable Formfactor Rev. 5.0, July 16, 2007

Exclusion zone for connector mating

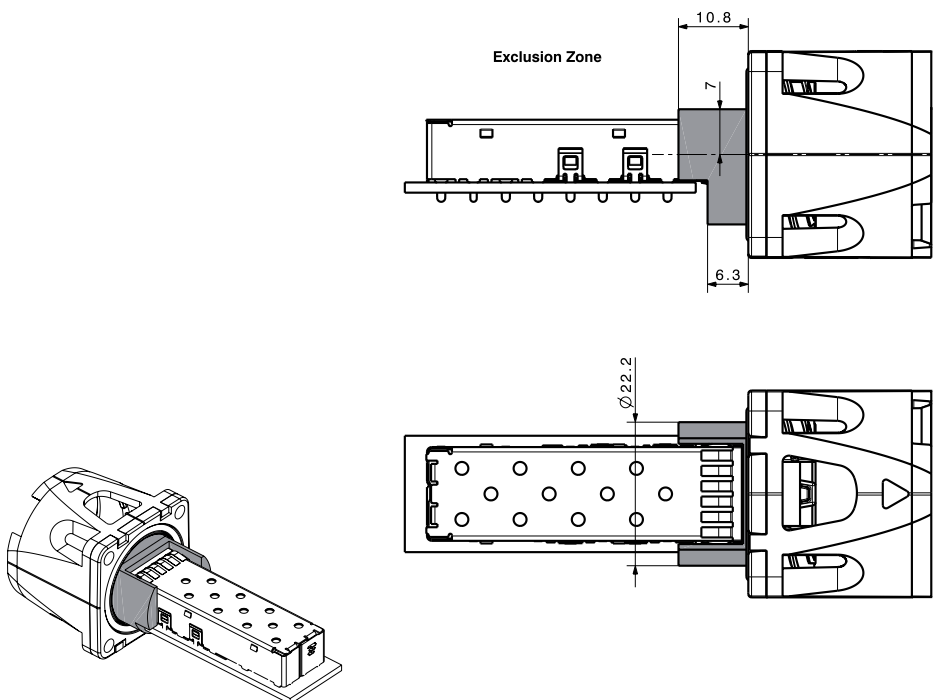

Fiber optic interfaces for remote radio heads

FullAXS – ruggedised sealing system



Features

- Ruggedised sealing system for fiber-to-the-antenna and industrial applications
- Open bulkhead for easy access to SFP
- Positive mechanical feedback to operator when fully mated
- Duplex LC interface
- Robust bayonet locking for easy, fast and secure mating
- Waterproof, dust proof and corrosion resistant
- Expansion to RJ45 and power possible

Specifications

Mating mechanism		bayonet style locking
Housing material		high performance plastic
Technology		LC with full ceramic ferrules
Mechanical performance	tensile load	150 N
	static side load	30 N
Operating temperature ¹⁾		-40 up to +70 °C
Mating durability	IEC 61300-2-2	100 cycles ²⁾
Ingress protection (mated)	IEC 60529	IP67
Vibration	IEC 61300-2-1	passed 10 to 500 Hz/10 g
Performance standards	IEC 61753-1 cat. E	compliant
	Telcordia GR 3120	compliant

Optical performance

Insertion loss	single-mode	typ. ≤ 0.20 dB	97 % ≤ 0.45 dB
	multimode	typ. ≤ 0.20 dB	97 % ≤ 0.50 dB
Return loss	single-mode	≥ 50 dB	

Type	Type new	Connector	Dust cap
Z4	FAP2	FullAXS plug 	IP65 
Item no. 84131095		FullAXS build-in flange 	IP65 

FullAXS is a registered trademark of TE.

Fiber optic interfaces for remote radio heads

Cleaning and inspection tools harsh environment connector

Cleaning

Description	Item no.	Picture
Cleaner IBC, ODC, 1.25 mm	84108853	
Cleaning brush, pin holes cleaning (Q-ODC-12 plug)	85066833	
Brushes for 85066833	84139206	
Swab, pins cleaning (Q-ODC-12 socket/extension/rearmount)	84139207	
IBC cleaner for Q-ODC-12	85017030	
Plug adapter for IBC cleaner (85017030)	85025275	
Socket/extension/rearmount adapter for IBC cleaner (85017030)	85025276	

ODC torque wrench

Description	Item no.	Picture
74_Z-0-0-321	22651994	

Fiber optic interfaces for remote radio heads

Inspection

Description	Item no.	Picture
Adapter for ODC-2 (plug and socket) inspection (JDSU 5000i probe)	85026607	
Adapter for ODC-4 (plug and socket) inspection (JDSU 5000i probe)	85026608	
Adapter for Q-ODC-2 (plug and socket) inspection (JDSU 5000i probe)	85083464	
Adapter for Q-ODC 12/Q-ODC 24 inspection (JDSU 5000i probe)	85068197	
Plug adapter multimode (UPC) for 85068197	85068173	
Plug adapter single-mode (APC) for 85068197	85068172	
Socket adapter multimode (UPC) for 85068197	85068170	
Socket adapter single-mode (APC) for 85068197	85068171	

Conventional cell site solutions



Work together with an expert for wireless connectivity solutions

Flexibility for your network architecture

One stop shop

Wireless infrastructure implies different technologies as radio frequency and fiber optics. HUBER+SUHNER copes with fiber optic and radio frequency and has for each application the suitable solution at hand. One stop shop reduces complexity for the purchaser and opens up additional economic potential.

Reduced operational costs

Performance

We constantly strive to optimise our products and pay special attention to the robustness of our RF components in order to guarantee a high electrical and mechanical reliability. Higher network efficiency and less maintenance leads to lower operational costs.

Expertise at your service

Local support

The successful deployment of wireless infrastructure requires strong local engineering and implementations capabilities. HUBER+SUHNER is close to the customer and provides local sales and engineering support.



LISCA – RF jumpers



LISCA cable assemblies are specially developed for applications where low VSWR and low attenuation combined with low intermodulation products are required. The excellent performance is achieved by utilising corrugated cables with low intermodulation connectors and a controlled assembly process with HUBER+SUHNER solder technology.

LISCA jumpers are factory-made cable assemblies and can be ordered in different lengths. A hot-polyamide moulding between connector and cable jacket guarantees highest stability and tightness.

Benefits

- RoHS compliant (2011/65/EU)
- Wide variety of corrugated cable and connector types
- Standard products as well as customised assemblies with special lengths and markings according to customer specifications
- High volume capacity thanks to standard assembly processing at all main HUBER+SUHNER production sites worldwide

LISCA – RF jumpers

Standard LISCA assemblies

These assemblies are produced under stringent quality manufacturing standards in order to achieve consistent high performance. All standard products are based on SUCOFEED cables with black PE jacket material. The assemblies are 100 % tested for attenuation and return loss according to the technical data. These LISCA products are factory-made cable assemblies and can only be ordered in predetermined lengths.

Features of standard LISCA

- Excellent RF performance
- High RF shielding efficiency
- Low attenuation
- Moisture protection IP68 High flexibility and small bending radius
- Low, stable intermodulation products

Customised LISCA assemblies

Strengths of HUBER+SUHNER also include the production of products according to customer specifications. This product line offers additional possibilities for demanding customer wishes based on the LISCA standard requirements, like improved return loss values, even better IM performance, customised labelling or assembly lengths up to 150 m.

Additional features

- Improved return loss values
 - Example: better -28 dB at 2.2 GHz with straight N, 4.3-10 or DIN 7/16 connectors
- 100 % factory tested products for intermodulation
 - Example: max. -155 dBc at 1.8 GHz with 2×20 W carriers
- Factory tested products on phase length/tolerance and delay time
- Specified for frequencies up to 6 GHz
- Customised marking, labelling and product packaging
- Special connector designs
- Products with lengths up to 120 m ability for your network architecture



LISCA – RF jumpers

Assembly performance code

Performance code		LIS...-52		LIS...-53	LIS...-71	LIS...-81	LIS...-01
Description		LTE*		Cluster Jumper	USA ¹⁾	Test leads	Customer specific
Impedance		50 Ω		50 Ω	50 Ω	50 Ω	50 Ω
Frequency (max. operating)		6 GHz	6 GHz	6 GHz	6 GHz	6 GHz	6 GHz
Length of assemblies		≤ 5 m	≤ 12 m	≤ 5 m	≤ 5 m	≤ 5 m	≤ 120 m
Return loss	DC to 1.0 GHz	≥ 29 dB	≥ 26 dB	≥ 28 dB	≥ 28 dB	≥ 24 dB	open
	> 1.0 to 2.2 GHz	≥ 27 dB	≥ 24 dB	≥ 27 dB	≥ 26 dB	≥ 24 dB	
	> 2.2 to 2.7 GHz	≥ 25 dB	≥ 22 dB	≥ 25 dB	–	–	
	> 2.7 to 4.0 GHz	≥ 22 dB	≥ 20 dB	≥ 21 dB	≥ 22 dB	–	
	> 4.0 to 6.0 GHz	–	–	≥ 18 dB	–	–	
Intermodulation	IM3 (2 × 20 W)	–160 dBc –163 dBc (typical)			–160 dBc	–165 dBc QN: –155 dBc	open
RF power	see cable specification						
Attenuation	see cable specification						

LTE = Long Term Evolution

¹⁾ special marking on cable

Assembly performance code

Connector pattern		Cable		Connector series									MQ4/MQ5		
				DIN 7/16	4.1-9.5 Mini DIN	N	QN	4.3-10 jack (f)	4.3-10 plug (m)						
	pattern code		cable/connector codes	716	4195	N	QN	4310	431X ¹⁾	431Y ²⁾	431Z ³⁾	MQ4 ¹⁾	MQ5X ¹⁾		
Straight plug (male)	11	1/4" HF 3/8" HF 1/2" HF 1/2	C5	●	–	●	●	n/a	●	–	●	●	●	●	
			C7	●	–	●	●	–	●	–	●	–	–	–	
			C9	●	●	●	●	●	●	●	●	●	–	–	–
			C12	●	●	●	●	–	●	●	●	●	–	–	–
Right angle plug (male)	16	1/4" HF 3/8" HF 1/2" HF 1/2	C5	●	–	●	●	n/a	●	–	●	–	–	–	
			C7	●	–	●	●	–	●	–	●	–	–	–	
			C9	●	●	●	●	●	●	–	–	●	–	–	
			C12	●	–	●	–	–	–	–	–	–	–	–	–
Straigh jack (female)	21	1/4" HF 3/8" HF 1/2" HF 1/2	C5	●	–	●	–	●	–	–	–	–	–	–	
			C7	●	–	●	–	●	–	–	–	–	–	–	
			C9	●	–	●	–	●	–	–	–	–	–	–	
			C12	●	–	●	–	●	–	–	–	–	–	–	

¹⁾ screw type

²⁾ hand screw type

³⁾ push-pull type

LISCA – RF jumpers

Order number for standard LISCA

			Example:				
			LIS	- C9	F - 11	431X - 11 - 431X	02000 - 52
			Product family				
Sucofeed_1/4_HF		C5	Cable type				
Sucofeed_3/8_HF		C7					
Sucofeed_1/2_HF		C9					
Sucofeed_1/2		C12					
Flame retardant: F PE: no indication							
Straight male		11	Pattern of connector		1		
Right angle male		16					
Straight female		21	Pattern of connector		2		
7/16		716	Connector interface		1 2		
7/16	with IP-boot	716B					
4.1-9.5		4195					
MQ4 plug (m)	screw type	MQ4X					
MQ5 plug (m)	screw type	MQ5X					
N		N					
N	with IP-boot	NB					
4.3-10 jack (f)		4310					
4.3-10 plug (m)	screw type	431X					
4.3-10 plug (m)	screw type with IP-boot	43XB					
4.3-10 plug (m)	hand screw type	431Y					
NEX10® plug (m)	screw type	NXX					
NEX10® plug (m)	screw type with IP-boot	NXXB					
			Assembly length in mm				
Jumper performance code	example: 52	Technical design and performance					

Rules for connector 1 and connector 2 description

1. For interface 1 and interface 2: numerical code before letter code (e.g. 716 before N).
2. For connector 1 use lower pattern code (e.g. 11 or 16 if pattern of connector 2 is 21).
3. If both connectors are of right angle, additional information about alignment is required.

Assembly length: tolerance $\pm 1\%$

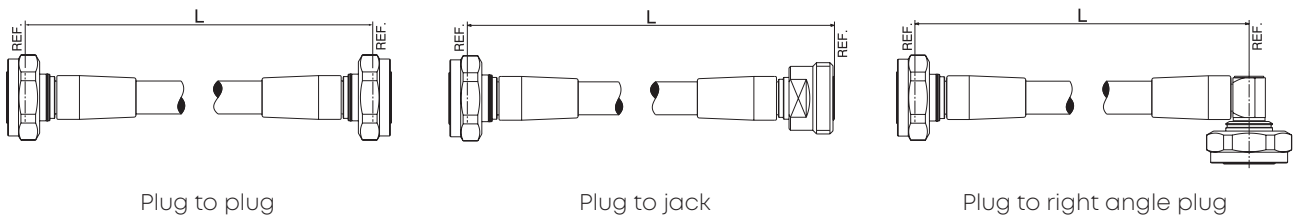

UWP – Universal Weather Protection



The Universal Weather Protection boot from HUBER+SUHNER offers protection for RF connector systems against weather, contamination and corrosion. The most common application involves jumpers installed between antennas and remote radio heads which go through extreme outdoor weather conditions. As compared to tape or boot solutions often requiring tools, the UWP offers an easy to use, reliable and multi cable compatibility in terms of jumper suppliers and cable sizes. Additionally the protection boot is reusable, i.e., in case of network upgrades it can be removed from existing cables and installed on to the new ones.

Universal boot solution for field terminated, factory assembled (Lisca) and existing jumpers For field terminated and factory assembled jumper applications, the boot can be easily installed before terminating the connector on to the cable. The installation of boot is fast and easy.

For applications where customers have existing jumpers on site without boot protection, UWP helps to use the same jumpers by simply sliding the boot over the connectors without any tools and giving full IP68 boot protection.

UWP – Universal Weather Protection



Features

- Multi cable brand and size compatible (1/2" and 1/2" flex)
- Fast and easy installation
- No tools or lubricants required
- Reusable
- Waterproof IP68
- UV resistant

Specifications

Environmental data	
Operating temperature (°C)	-65 to +85
Installation temperature (°C)	-25 to +60
Storage temperature (°C)	-70 to +85
Waterproof degree	IP68 (1 m, 24 hrs, 20 °C)
2011/65/EU (RoHS)	compliant
UV resistance	yes
Flame resistance	UL94- HB
Material data	
Material	Silicon/black
Number of operations	20 matings of boot 2 installations over the connector through back end of boot

Order information

Part number*	Connector type	Min. neck length „A“ (mm)	Min.-Max. diameter „B“ (mm)	Min.-Max. diameter „C“ (mm)	Weight (g)
62_4310-U0-0-6	4.3-10	14	17 to 19	19 to 21	50.5
62_N-U0-0-20	N	14	13 to 18	N/A	51.1
62_716-U0-0-6	7/16	13	25 to 27	N/A	76.1

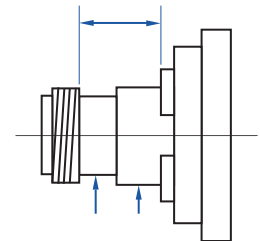

SUCOFEED – corrugated cables



HUBER+SUHNER SUCOFEED product range of foam corrugated coaxial cables with suitable stripping tools. The cables have excellent electrical, mechanical and environmental properties for indoor as well as outdoor installations.

The cables promise optimal shielding, low attenuation, low VSWR, remarkable intermodulation performance and flexibility for handling and installation on sites.

SUCOFEED cables are available as made from copper as well as from aluminium. For the US IBC market plenum rated „h“ cable is part of our corrugated cable proposition.

Features

- Low IM distortion levels
- Low loss
- Flame retardant designs available
- High power capability
- High shielding effectiveness
- UV resistant
- Guaranteed performance up to 3 GHz

Benefits

- High efficient signal distribution
- Excellent for multi-operator DAS
- Economic high performance solution if assembled with Quick-Fit connectors

SUCOFEED – corrugated cables

1/4" high-flex



Cable design	Order/type no.	SUCOFEED_1/4_HF	SUCOFEED_1/4_HF_FR
	Dimension	1/4" high-flex	1/4" high-flex
	Jacket version	Standard	Flame retardant
Inner conductor	Ø in mm	1.90	1.90
Dielectric	Ø in mm	4.60	4.60
Outer conductor	Ø in mm	6.40	6.40
Jacket	Ø in mm	7.60	7.60

Electrical data			
Typ. operating frequency	GHz	≤ 18	≤ 18
Impedance	Ω	50 ± 1	50 ± 1
Capacitance	pF/m	79.7	79.7
Relative signal propagation	%	83.5	83.5
Signal delay	ns/m	4.00	4.00
Max. operating voltage	kVrms	0.6	0.6
Typ. attenuation at 1 GHz	dB/100 m	19.54	19.54
Typ. attenuation at 2 GHz	dB/100 m	28.45	28.45
Typ. attenuation at 2.2 GHz	dB/100 m	29.98	29.98
Typ. attenuation at 2.5 GHz	dB/100 m	32.17	32.17
Typ. attenuation at 3.0 GHz	dB/100 m	35.60	35.60
Max. power at 1 GHz (40 °C)	kW	≤ 0.290	≤ 0.290
Max. power at 2 GHz (40 °C)	kW	≤ 0.205	≤ 0.205
Max. power at 2.2 GHz (40 °C)	kW	≤ 0.196	≤ 0.196
Max. power at 2.5 GHz (40 °C)	kW	≤ 0.183	≤ 0.183
Max. power at 3.0 GHz (40 °C)	kW	≤ 0.167	≤ 0.167

General data			
Temp. range operating	°C	-55/+85	-40/+85
Temp. range installation	°C	-25/+60	-25/+60
Typ. weight	kg/100 m	7.5	8.7
Min. bending radius	mm	25	25

For detailed data sheets please go to www.hubersuhner.com and then search for type „SUCOFEED“.

SUCOFEED – corrugated cables

3/8" high-flex



Cable design	Order/type no.	SUCOFEED_3/8_HF	SUCOFEED_3/8_HF_FR
	Dimension	3/8" high-flex	3/8" high-flex
	Jacket version	Standard	Flame retardant
Inner conductor	Ø in mm	2.80	2.80
Dielectric	Ø in mm	7.00	7.00
Outer conductor	Ø in mm	9.50	9.50
Jacket	Ø in mm	10.80	10.80

Electrical data			
Typ. operating frequency	GHz	≤ 12	≤ 12
Impedance	Ω	50 ± 1	50 ± 1
Capacitance	pF/m	79.5	79.5
Relative signal propagation	%	83	83
Signal delay	ns/m	4.00	4.00
Max. operating voltage	kVrms	0.9	0.9
Typ. attenuation at 1 GHz	dB/100 m	13.33	13.33
Typ. attenuation at 2 GHz	dB/100 m	19.43	19.43
Typ. attenuation at 2.2 GHz	dB/100 m	20.48	20.48
Typ. attenuation at 2.5 GHz	dB/100 m	21.99	21.99
Typ. attenuation at 3.0 GHz	dB/100 m	24.34	24.34
Max. power at 1 GHz (40 °C)	kW	≤ 0.540	≤ 0.540
Max. power at 2 GHz (40 °C)	kW	≤ 0.382	≤ 0.382
Max. power at 2.2 GHz (40 °C)	kW	≤ 0.364	≤ 0.364
Max. power at 2.5 GHz (40 °C)	kW	≤ 0.342	≤ 0.342
Max. power at 3.0 GHz (40 °C)	kW	≤ 0.312	≤ 0.312

General data			
Temp. range operating	°C	-55/+85	-40/+85
Temp. range installation	°C	-25/+60	-25/+60
Typ. weight	kg/100 m	12.2	13.2
Min. bending radius	mm	25	25

For detailed data sheets please go to www.hubersuhner.com and then search for type „SUCOFEED“.

SUCOFEED – corrugated cables

1/2" high-flex



Cable design	Order/type no.	SUCOFEED_1/2_HF	SUCOFEED_1/2_HF_FR
	Dimension	1/2" high-flex	1/2" high-flex
	Jacket version	Standard	Flame retardant
Inner conductor	Ø in mm	3.60	3.60
Dielectric	Ø in mm	9.0	9.0
Outer conductor	Ø in mm	12.20	12.20
Jacket	Ø in mm	13.40	13.40

Electrical data			
Typ. operating frequency	GHz	≤ 10	≤ 10
Impedance	Ω	50 ± 1	50 ± 1
Capacitance	pF/m	80.3	80.3
Relative signal propagation	%	81	81
Signal delay	ns/m	4.00	4.00
Max. operating voltage	kVrms	1.27	1.27
Typ. attenuation at 1 GHz	dB/100 m	11.77	11.77
Typ. attenuation at 2 GHz	dB/100 m	17.48	17.48
Typ. attenuation at 2.2 GHz	dB/100 m	18.48	18.48
Typ. attenuation at 2.5 GHz	dB/100 m	19.92	19.92
Typ. attenuation at 3.0 GHz	dB/100 m	22.19	22.19
Max. power at 1 GHz (40 °C)	kW	≤ 0.83	≤ 0.83
Max. power at 2 GHz (40 °C)	kW	≤ 0.587	≤ 0.587
Max. power at 2.2 GHz (40 °C)	kW	≤ 0.56	≤ 0.56
Max. power at 2.5 GHz (40 °C)	kW	≤ 0.525	≤ 0.525
Max. power at 3.0 GHz (40 °C)	kW	≤ 0.479	≤ 0.479

General data			
Temp. range operating	°C	-55/+85	-40/+85
Temp. range installation	°C	-25/+60	-25/+60
Typ. weight	kg/100 m	20	20
Min. bending radius	mm	25	25

For detailed data sheets please go to www.hubersuhner.com and then search for type „SUCOFEED“.

SUCOFEED – corrugated cables

1/2" annular



Cable design	Order/type no.	SUCOFEED_1/2	SUCOFEED_1/2_FR
	Dimension	1/2"	1/2"
	Jacket version	Standard	Flame retardant
Inner conductor	Ø in mm	4.80	4.80
Dielectric	Ø in mm	12.10	12.10
Outer conductor	Ø in mm	13.80	13.80
Jacket	Ø in mm	15.90	15.90

Electrical data			
Typ. operating frequency	GHz	≤ 8	≤ 8
Impedance	Ω	50 ± 1	50 ± 1
Capacitance	pF/m	75.9	75.9
Relative signal propagation	%	88	88
Signal delay	ns/m	3.80	3.80
Max. operating voltage	kVrms	1.60	1.60
Typ. attenuation at 1 GHz	dB/100 m	7.29	7.29
Typ. attenuation at 2 GHz	dB/100 m	10.62	10.62
Typ. attenuation at 2.2 GHz	dB/100 m	11.20	11.20
Typ. attenuation at 2.5 GHz	dB/100 m	12.02	12.02
Typ. attenuation at 3.0 GHz	dB/100 m	13.31	13.31
Max. power at 1 GHz (40 °C)	kW	≤ 1.040	≤ 1.040
Max. power at 2 GHz (40 °C)	kW	≤ 0.735	≤ 0.735
Max. power at 2.2 GHz (40 °C)	kW	≤ 0.701	≤ 0.701
Max. power at 2.5 GHz (40 °C)	kW	≤ 0.658	≤ 0.658
Max. power at 3.0 GHz (40 °C)	kW	≤ 0.600	≤ 0.600

General data			
Temp. range operating	°C	-55/+85	-40/+85
Temp. range installation	°C	-25/+60	-25/+60
Typ. weight	kg/100 m	25.0	27.6
Min. bending radius	mm	70	70

For detailed data sheets please go to www.hubersuhner.com and then search for type „SUCOFEED“.

SUCOFEED – corrugated cables

7/8" high-flex and annular



Cable design	Order/type no.	SUCOFEED_7/8_HF	SUCOFEED_7/8
	Dimension	7/8" high-flex	7/8"
	Jacket version	Standard	Flame retardant
Inner conductor	Ø in mm	9.40	9.00
Dielectric	Ø in mm	22.40	22.30
Outer conductor	Ø in mm	25.00	24.80
Jacket	Ø in mm	27.50	27.60

Electrical data			
Typ. operating frequency	GHz	≤ 4.9	≤ 5
Impedance	Ω	50 ± 1	50 ± 1
Capacitance	pF/m	75.4	75.8
Relative signal propagation	%	85	88
Signal delay	ns/m	3.90	3.80
Max. operating voltage	kVrms	3.00	2.91
Typ. attenuation at 1 GHz	dB/100 m	4.25	4.11
Typ. attenuation at 2 GHz	dB/100 m	6.42	6.11
Typ. attenuation at 2.2 GHz	dB/100 m	6.81	6.46
Typ. attenuation at 2.5 GHz	dB/100 m	7.37	6.96
Typ. attenuation at 3.0 GHz	dB/100 m	8.26	7.76
Max. power at 1 GHz (40 °C)	kW	≤ 1.940	≤ 2.190
Max. power at 2 GHz (40 °C)	kW	≤ 1.372	≤ 1.549
Max. power at 2.2 GHz (40 °C)	kW	≤ 1.308	≤ 1.476
Max. power at 2.5 GHz (40 °C)	kW	≤ 1.227	≤ 1.385
Max. power at 3.0 GHz (40 °C)	kW	≤ 1.120	≤ 1.264

General data			
Temp. range operating	°C	-55/+85	-40/+85
Temp. range installation	°C	-25/+60	-25/+60
Typ. weight	kg/100 m	48.0	53
Min. bending radius	mm	90	120

For detailed data sheets please go to www.hubersuhner.com and then search for type „SUCOFEED“.

SUCOFEED – corrugated cables

7/8" annular



Cable design	Order/type no.	SUCOFEED_7/8_FR	SUCOFEED_7/8_LA	SUCOFEED_7/8_LA_FR
	Dimension	7/8"	7/8" low attenuation	7/8" low attenuation
	Jacket version	Flame retardant	Standard	Flame retardant
Inner conductor	Ø in mm	9.00	9.50	9.50
Dielectric	Ø in mm	22.30	22.70	22.70
Outer conductor	Ø in mm	24.80	25.40	25.40
Jacket	Ø in mm	27.60	27.90	27.90

Electrical data				
Typ. operating frequency	GHz	≤ 5	≤ 5.0	≤ 5.0
Impedance	Ω	50 ± 1	50 ± 1	50 ± 1
Capacitance	pF/m	75.8	73.8	73.8
Relative signal propagation	%	88	90.3	90.3
Signal delay	ns/m	3.80	3.70	3.70
Max. operating voltage	kVrms	2.91	3.00	3.00
Typ. attenuation at 1 GHz	dB/100 m	4.11	3.76	3.76
Typ. attenuation at 2 GHz	dB/100 m	6.11	5.53	5.53
Typ. attenuation at 2.2 GHz	dB/100 m	6.46	5.83	5.83
Typ. attenuation at 2.5 GHz	dB/100 m	6.96	6.28	6.28
Typ. attenuation at 3.0 GHz	dB/100 m	7.76	6.97	6.97
Max. power at 1 GHz (40 °C)	kW	≤ 2190	≤ 2.440	≤ 2.440
Max. power at 2 GHz (40 °C)	kW	≤ 1.549	≤ 1.725	≤ 1.725
Max. power at 2.2 GHz (40 °C)	kW	≤ 1.476	≤ 1.645	≤ 1.645
Max. power at 2.5 GHz (40 °C)	kW	≤ 1.385	≤ 1.543	≤ 1.543
Max. power at 3.0 GHz (40 °C)	kW	≤ 1.264	≤ 1.409	≤ 1.409

General data				
Temp. range operating	°C	-40/+85	-55/+85	-40/+85
Temp. range installation	°C	-25/+60	-25/+60	-25/+60
Typ. weight	kg/100 m	65.0	48	52
Min. bending radius	mm	120	120	120

For detailed data sheets please go to www.hubersuhner.com and then search for type „SUCOFEED“.

SUCOFEED – corrugated cables

1 1/4" annular



Cable design	Order/type no.	SUCOFEED_1_1/4	SUCOFEED_1_1/4_FR
	Dimension	1_1/4"	1_1/4"
	Jacket version	Standard	Flame retardant
Inner conductor	Ø in mm	13.10	13.10
Dielectric	Ø in mm	32.40	32.40
Outer conductor	Ø in mm	35.80	35.80
Jacket	Ø in mm	39.50	39.50

Electrical data			
Typ. operating frequency	GHz	≤ 3	≤ 3
Impedance	Ω	50 ± 1	50 ± 1
Capacitance	pF/m	76.5	76.5
Relative signal propagation	%	88	88
Signal delay	ns/m	3.80	3.80
Max. operating voltage	kVrms	4.20	4.20
Typ. attenuation at 1 GHz	dB/100 m	2.94	2.94
Typ. attenuation at 2 GHz	dB/100 m	4.43	4.43
Typ. attenuation at 2.2 GHz	dB/100 m	4.69	4.69
Typ. attenuation at 2.5 GHz	dB/100 m	5.08	5.08
Typ. attenuation at 3.0 GHz	dB/100 m	5.68	5.68
Max. power at 1 GHz (40 °C)	kW	≤ 3.120	≤ 3.120
Max. power at 2 GHz (40 °C)	kW	≤ 2.206	≤ 2.206
Max. power at 2.2 GHz (40 °C)	kW	≤ 2.104	≤ 2.104
Max. power at 2.5 GHz (40 °C)	kW	≤ 1.973	≤ 1.973
Max. power at 3.0 GHz (40 °C)	kW	≤ 1.801	≤ 1.801

General data			
Temp. range operating	°C	-55/+85	-40/+85
Temp. range installation	°C	-25/+60	-25/+60
Typ. weight	kg/100 m	92	110.0
Min. bending radius	mm	200	200

For detailed data sheets please go to www.hubersuhner.com and then search for type „SUCOFEED“.

SUCOFEED – corrugated cables

1 5/8" annular



Cable design	Order/type no.	SUCOFEED_1_5/8_LA	SUCOFEED_1_5/8_LA_FR
	Dimension	1 5/8" low attenuation	1 5/8" low attenuation
	Jacket version	standard	flame retardant
Inner conductor	Ø in mm	17.60	17.60
Dielectric	Ø in mm	41.00	41.00
Outer conductor	Ø in mm	46.50	46.50
Jacket	Ø in mm	50.30	50.30

Electrical data			
Typ. operating frequency	GHz	≤ 2.75	≤ 2.75
Impedance	Ω	50 ± 1	50 ± 1
Capacitance	pF/m	72.50	72.50
Relative signal propagation	%	92	92
Signal delay	ns/m	3.80	3.80
Max. operating voltage	kVrms	5.50	5.50
Typ. attenuation at 1 GHz	dB/100 m	2.25	2.25
Typ. attenuation at 2 GHz	dB/100 m	3.36	3.36
Typ. attenuation at 2.2 GHz	dB/100 m	3.56	3.56
Typ. attenuation at 2.5 GHz	dB/100 m	3.84	3.84
Typ. attenuation at 3.0 GHz	dB/100 m	4.02	4.02
Max. power at 1 GHz (40 °C)	kW	≤ 4.100	≤ 4.100
Max. power at 2 GHz (40 °C)	kW	≤ 2.899	≤ 2.899
Max. power at 2.2 GHz (40 °C)	kW	≤ 2.764	≤ 2.764
Max. power at 2.5 GHz (40 °C)	kW	≤ 2.593	≤ 2.593
Max. power at 3.0 GHz (40 °C)	kW	≤ 2.495	≤ 2.495

General data			
Temp. range operating	°C	-55/+85	-40/+85
Temp. range installation	°C	-25/+60	-25/+60
Typ. weight	kg/100 m	110.0	130.0
Min. bending radius	mm	300	300

For detailed data sheets please go to www.hubersuhner.com and then search for type „SUCOFEED“.

SUCOFEEED aluminium – corrugated cables



HUBER+SUHNER SUCOFEEED_LW is a foam dielectric corrugated coaxial cable designed with an aluminium outer conductor and a copper clad inner conductor. This low weight SUCOFEEED_LW family is a cost efficient alternative to the copper transmission lines. The performance of the aluminium cables is equivalent to the copper transmission cables. Our FR and UL types provide enhanced flame-resistance and therefore excellent choice for indoor DAS applications.

Applications

- Cost efficient solution
- High efficient signal distribution
- Excellent for multi-operator DAS
- Economic high performing solution if assembled with Quick-Fit connectors

Features

- Light weight
- Electrical performance similar to copper cables
- HUBER+SUHNER connectors are fully compatible with aluminium and copper cables
- Cables with flame-retardant jackets on request

SUCOFEED aluminium – corrugated cables

1/2" and 7/8" light weight



Cable design	Order/type no.	SUCOFEED_1/2_LW	SUCOFEED_1/2_LW_LA
	Dimension	1/2"	7/8" low attenuation
	Jacket version	PE	PE
Inner conductor	Ø in mm	4.80	9.40
Dielectric	Ø in mm	12.20	22.80
Outer conductor	Ø in mm	13.80	25.30
Jacket	Ø in mm	15.90	27.50

Electrical data			
Typ. operating frequency	GHz	≤ 8.8	≤ 5
Impedance	Ω	50 ± 1	50 ± 1
Capacitance	pF/m	76	74
Relative signal propagation	%	88	90
Signal delay	ns/m	3.80	3.80
Max. operating voltage	kVrms	1.95	2.95
Typ. attenuation at 1 GHz	dB/100 m	7.76	4.16
Typ. attenuation at 2 GHz	dB/100 m	11.38	6.08
Typ. attenuation at 2.2 GHz	dB/100 m	12.00	6.41
Typ. attenuation at 2.5 GHz	dB/100 m	12.90	6.88
Typ. attenuation at 3.0 GHz	dB/100 m	14.31	7.62
Max. power at 1 GHz (40 °C)	kW	≤ 1.020	≤ 2.520
Max. power at 2 GHz (40 °C)	kW	≤ 0.721	≤ 1.782
Max. power at 2.2 GHz (40 °C)	kW	≤ 0.688	≤ 1.699
Max. power at 2.5 GHz (40 °C)	kW	≤ 0.645	≤ 1.594
Max. power at 3.0 GHz (40 °C)	kW	≤ 0.589	≤ 1.455

General data			
Temp. range operating	°C	-55/+85	-55/+85
Temp. range installation	°C	-40/+60	-40/+60
Typ. weight	kg/100 m	≤ 17.5	≤ 37
Min. bending radius	mm	70/125	120/250

For detailed data sheets please go to www.hubersuhner.com and then search for type „SUCOFEED“.

SUCOFEED aluminium – corrugated cables

1-1/4" and 1-5/8" light weight

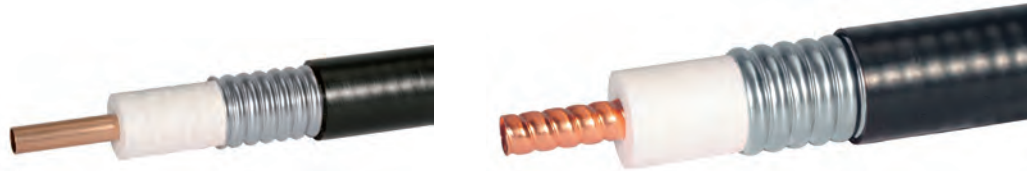

Cable design	Order/type no.	SUCOFEED_1_1/4_LW	SUCOFEED_1_5/8_LW_LA
	Dimension	1-1/4"	1-5/8" low attenuation
	Jacket version	PE	PE
Inner conductor	Ø in mm	13.10	17.60
Dielectric	Ø in mm	32.00	41.50
Outer conductor	Ø in mm	36.00	46.50
Jacket	Ø in mm	39.20	50.30

Electrical data			
Typ. operating frequency	GHz	≤ 3.60	≤ 2.75
Impedance	Ω	50 ± 1	50 ± 1
Capacitance	pF/m	75	74
Relative signal propagation	%	88	89
Signal delay	ns/m	3.8	3.8
Max. operating voltage	kVrms	4.2	5.6
Typ. attenuation at 1 GHz	dB/100 m	3.20	2.48
Typ. attenuation at 2 GHz	dB/100 m	4.70	3.69
Typ. attenuation at 2.2 GHz	dB/100 m	4.97	3.91
Typ. attenuation at 2.5 GHz	dB/100 m	5.34	4.21
Typ. attenuation at 3.0 GHz	dB/100 m	5.58	4.41
Max. power at 1 GHz (40 °C)	kW	≤ 3.350	≤ 4.100
Max. power at 2 GHz (40 °C)	kW	≤ 2.369	≤ 2.899
Max. power at 2.2 GHz (40 °C)	kW	≤ 2.259	≤ 2.764
Max. power at 2.5 GHz (40 °C)	kW	≤ 2.119	≤ 2.593
Max. power at 3.0 GHz (40 °C)	kW	≤ 2.039	≤ 2.690

General data			
Temp. range operating	°C	-55/+85	-55/+85
Temp. range installation	°C	-40/+60	-40/+60
Typ. weight	kg/100 m	≤ 65	≤ 99
Min. bending radius	mm	200/400	280/500

For detailed data sheets please go to www.hubersuhner.com and then search for type „SUCOFEED“.

Flexible RF plenum jumper



Plenum rated RF assembly with cable Sucoform 122/141/222

HUBER+SUHNER standard plenum jumper with Sucoform cables (SPJ/SM) for applications where optimum VSWR and attenuation combined with low intermodulation products are required. Perfectly designed for connectivity solution for indoor and outdoor DAS and small cell installations, coax-link between antennas and feeder-lines or between components in an active or passive DAS tray.

- Excellent low loss (attenuation/return loss)
- Low PIM
- Small bending radius
- Plenum certified cables
- Excellent shielding performance

RF cable assembly SPJ/SM

Standard plenum jumper with Sucoform cables

Cable types	Cable attenuation	Jacket diameter	Bending radius
Sucoform 122 LA Cu CMP	0.66 dB/m @ 2.7 GHz	3.75 mm	min. 5 mm
Sucoform 141 LA Cu CMP	0.61 dB/m @ 2.7 GHz	4.20 mm	min. 8 mm
Sucoform 222 LA Cu CMP	0.41 dB/m @ 2.7 GHz	6.20 mm	min. 25 mm

Connector types	Male straight	Male angle	Female straight
DIN 7/16	X	X	X
DIN 4.1/9.5	X	X	X
N	X	X	X
4.3-10-X (HEX. Nut)	X	X	X
SMA	X	X	X
QMA	X		
NEX10	X	X	X

Technical data			
Frequency range	DC up to 6 GHz		
Return loss	Frequency 0.38 to 1.0 GHz up to 2.2 GHz up to 2.7 GHz up to 3.8 GHz up to 6 GHz	Straight/straight ≥ 29 dB ≥ 27 dB ≥ 26 dB ≥ 23 dB ≥ 20 dB	Straight/angle ≥ 28 dB ≥ 25 dB ≥ 24 dB ≥ 20 dB ≥ 19 dB
PIM performance at 1.8GHz 2 × 43dBm	≤ 160 dBc (QMA: ≤ 140 dBc)	typical -165 dBc	

Environmental data	
Temperature range	-40 to 105 °C
Waterproof	IP67 (0.5 m/1 h/20 °C)
Cable performance	UV resistance
	UL444/CMP/FT6, ETL listed
	jacket colour: white
Further information	100 % tested for return loss, attenuation and PIM Serial product label on each jumper for tracking Stock items in lengths of 0.5 up to 5 m



Copper – corrugated cables



HUBER+SUHNER plenum rated coaxial cable for in-building applications

SUCOFEEED 1/2" PW is a plenum rated wideband coaxial cable designed to deliver outstanding electrical performance up to 6 GHz and support wireless in-building plenum applications. It maintains compatibility with existing connectors, tools, mounting hardware for easy and convenient installation. This plenum cable has a star-shaped profile extruded low loss dielectric and a solid copper outer conductor which provides excellent RF shielding.

Features

- Outstanding electrical performance
 - Low attenuation/high power rating
- Excellent intermodulation values
- Plenum rated
 - CMP, ETL listed to UL444, Canadian CSA 22.2/FT6
- White plenum jacket with temperature stabilised polymer material

Benefits

- Compatible with existing field mountable connectors
- Minimised system interferences

Copper – corrugated cables

1/2" PW

Cable design	Order/type no.	SUCOFEEED_1/2_PW
	Dimension	1/2"
	Jacket version	plenum rated white PVC
Inner conductor	Ø in mm	4.8
Dielectric	Ø in mm	11.8
Outer conductor	Ø in mm	13.8
Jacket	Ø in mm	16

Electrical data

Impedance	Ω	50
Max. operating frequency	GHz	6
Capacitance	pF/m	76
Velocity of signal propagation	%	88
Insulation resistance	10 ⁶ MΩm	≥ 5 ×
Min. screening effectiveness	dB	> 120
Max. operating voltage	kVrms (at sea level)	4

Mechanical data

Weight		kg/100 m	26
Min. bending radius	static	mm	70
	repeated (max. 20 bendings)	mm	125
	dynamic	mm	250

Environmental data

Temperature range	-20 to + 80 °C
Installation temperature	-20 to + 80 °C
Flammability	ETL listed to UL444, CMP/FT6
Smoke density	UL444/CMP/FT6, ETL listed
2011/65/EC (RoHS)	compliant

Frequency MHz	Nom. attenuation dB/100 m	Nom. attenuation dB/100 ft	Average power kW
	sea level, 20 °C ambient temperature		sea level, 40 °C ambient, inner conductor 100 °C
50	1.59	0.47	4.52
100	2.19	0.67	3.20
150	2.71	0.82	2.61
200	3.15	0.96	2.26
450	4.85	1.48	1.60
600	5.68	1.73	1.30
700	6.18	1.88	1.21
800	6.65	2.03	1.13
900	7.08	2.16	1.07
1000	7.53	2.29	1.01
1500	9.46	2.88	0.83

Frequency MHz	Nom. attenuation dB/100 m	Nom. attenuation dB/100 ft	Average power kW
	sea level, 20 °C ambient temperature		sea level, 40 °C ambient, inner conductor 100 °C
1700	10.16	3.10	0.78
1800	10.50	3.20	0.75
2000	11.16	3.40	0.71
2200	11.80	3.60	0.68
2700	13.30	4.06	0.62
3000	14.16	4.32	0.58
3400	15.26	4.65	0.55
3800	16.31	4.97	0.52
4000	16.82	5.13	0.51
5000	19.28	5.88	0.45
6000	21.58	6.58	0.41

Quick-Fit coaxial connectors

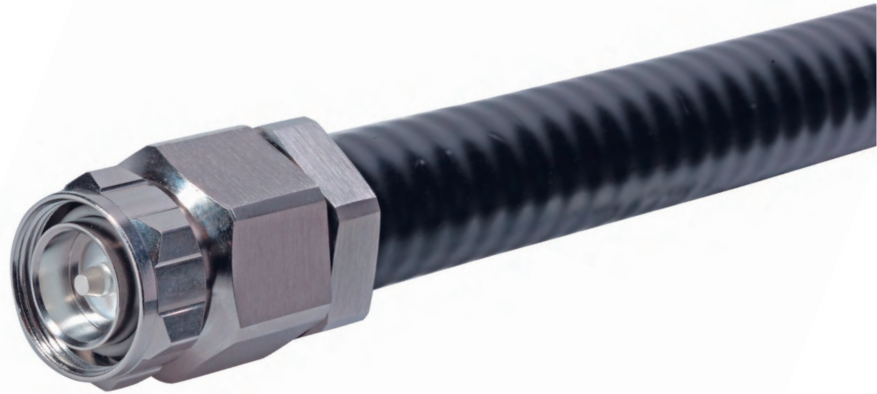

HUBER+SUHNER Quick-Fit connectors are worldwide approved connectors for foam dielectric corrugated tube cables. They offer a greatly simplified and economic approach to cable preparation and assembly. The product line meets the requirements of multi-carrier, high-channel-count transceivers such as base stations of today's mobile communication infrastructure networks.

Features

- Excellent RF performance
- Low, stable and reproducible IM (Passive InterModulation) – typically -155 dBc
- Safe assembly process performance – in-field termination with reproducible electrical performance
- Quick and easy assembly – 2 main connector parts, 4 steps in less than 4 minutes
- High IP rating – IP68
- Multi-brand, multi-design and multi-material cable compatibility

Quick-Fit coaxial connectors

General technical data

Electrical data	4.3-10	7/16	N
Impedance (Ω)	50		
Frequency range	DC up to 12 GHz	DC up to 7.5 GHz	DC up to 11 GHz
VSWR	≤ 1.03 , DC up to 4 GHz ≤ 1.05 , 4 GHz up to 6 GHz	≤ 1.06 , DC up to 2.5 GHz	≤ 1.06 , DC up to 2.5 GHz
PIM ¹⁾	typical -155 dBc, better than -150 dBc		

¹⁾ Carrier to 3rd order intermodulation product ratio with 2×20 W (43 dBm) carrier power

Mechanical data	4.3-10	7/16	N
Recommended coupling nut torque IEC	screw type: ≥ 5 Nm (proof torque 8 Nm)	25 up to 30 Nm 18.05 up to 21.66 ft lb. IEC 61169-4	0.68 up to 1.13 Nm 0.49 up to 0.82 ft lb. IEC 61169-16
Recommended coupling nut torque HUBER+SÜHNER			3 Nm/2.2 ft lb. ≥ 500 with 100 matings max.
Engagement force	typical 100 N (quick lock)		
Separation force	typical 80 N (quick lock)		
Coupling nut retention force		≥ 1000 N/225.0 lbs	≥ 450 N/101.2 lbs
Centre contact	captivated	captivated	captivated
Durability (matings)	≥ 100	≥ 500	≥ 500

Environmental data	4.3-10	7/16	N
Temperature range	-40 up to $+85$ °C -40 up to $+185$ °F	-40 up to $+85$ °C -40 up to $+185$ °F	-40 up to $+85$ °C -40 up to $+185$ °F
IP rating	IP67 (acc. to IEC 60529) with taping or similar measures IP68		

Material data	4.3-10	7/16	N
Connector part	4.3-10	7/16	N
Outer contacts/connector bodies	brass / SUCOPLATE®	brass / SUCOPLATE®	brass / SUCOPLATE®
Cable entries/coupling nuts	brass / SUCOPLATE®	brass / SUCOPLATE®	brass / SUCOPLATE®
Centre contacts	spring bronze/brass/silver	spring bronze/brass/silver	spring bronze/brass/silver
Insulators	PTFE or PFA	PTFE or PFA	PTFE or PFA
Gaskets	VMQ (silicon rubber)	EPDM (natural rubber)	EPDM (natural rubber)

Some connectors may have a specification that differs from the above mentioned data. The products are designed and guaranteed to pass the above mentioned test procedures. Any additional or different requirement arising from specific applications or environmental conditions which is not covered by these test procedures is subject to request.

Quick-Fit coaxial connectors

Suitable for SUCOFEEED corrugated cables in the diameters below



1/2" _HF, 1/2" _HF_FR, 1/2" _HF_FR_UL

HUBER+SUHNER type	Item no.	Interface	Assembly instruction	Tools	Item no. tools
11_716-50-9-9	22660309	DIN 7/16 male	DOC-0000179418	74_Z-0-9-15	23001006
16_716-50-9-5	23007298	DIN 7/16 male right angle			
21_716-50-9-9	22660310	DIN 7/16 female			
11_N-50-9-9	22660311	N male			
16_N-50-9-6	23007299	N female right angle			
21_N-50-9-9	22660312	N female			

Cable compatibility list on request.



1/2", 1/2" _FR, 1/2" _FR_UL

HUBER+SUHNER type	Item no.	Interface	Assembly instruction	Tools	Item no. tools
11_716-50-12-50	84201175	DIN 7/16 male	DOC-0000386367	74_Z-0-12-25 74_Z-0-12-8	84147226
16_716-50-12-50	84201179	DIN 7/16 male right angle			
21_716-50-12-50	84201177	DIN 7/16 female			
11_N-50-12-50	84201169	N male			
16_N-50-12-50	84201181	N male right angle			
21_N-50-12-50	84201173	N female			
11_4310-50-12-X2	85020537	4.3-10 male screw			
11_4310-50-12-Y2	85021551	4.3-10 male hand screw			
11_4310-50-12-Z2	85021552	4.3-10 male quick lock			
21_4310-50-12-1	85029736	4.3-10 female			

Cable compatibility list on request.



7/8", 7/8" _FR, 7/8" _LA, 7/8" _LA_FR

HUBER+SUHNER type	Item no.	Interface	Assembly instruction	Tools	Item no. tools
11_716-50-23-44	84069135	DIN 7/16 male	DOC-0000295365	74_Z-0-23-100	84133923 84074476
21_716-50-23-44	84069194	DIN 7/16 female			
11_N-50-23-43	84124063	N male			
21_N-50-23-43	84124062	N female			

Cable compatibility list on request.

Quick-Fit coaxial connectors

Suitable for SUCOFEEED corrugated cables in the diameters below



7/8" _HF

HUBER+SUHNER type	Item no.	Interface	Assembly instruction	Tools	Item no. tools
11_N-50-23-41	84024502	N male	DOC-0000243751	74_Z-0-23-16	23035267
21_N-50-23-41	84024596	N female			

Cable compatibility list on request.



1/2", 1/2" _FR, 1/2" _FR_UL

HUBER+SUHNER type	Item no.	Interface	Assembly instruction	Tools	Item no. tools
21_716-50-32-4	84116150	7/16 female	DOC-0000341341	74_Z-0-32-14 74_Z-0-32-15	23010533 84120843

Cable compatibility list on request.



1_5/8" _LA







HUBER+SUHNER type	Item no.	Interface	Assembly instruction	Tools	Item no. tools
21_716-50-42-4	84079305	7/16 female	DOC-0000299051	74_Z-0-42-14 74_Z-0-42-15	23010534 84085074

Cable compatibility list on request.

Cable stripping tools



for Quick-Fit and HUBER+SUHNER Eco connectors

Automating rotation stripping tools (can be used manually as well)



Automating rotation stripping tools		Cable type	Connector		Picture and remarks
Type no.	Item no.		Type no.	Item no.	
74_Z-0-9-15	23001006	SUCCOFEED_1/2_HF SUCCOFEED_1/2_HF_FR SUCCOFEED_1/2_HF_FR_UL	11_716-50-9-9	22660309	
			16_716-50-9-5	23007298	
			21_716-50-9-9	22660310	
			11_N-50-9-9	22660311	
			16_N-50-9-6	23007299	
21_N-50-9-9	22660312				
74_Z-0-12-11	84147226	SUCCOFEED_1/2 SUCCOFEED_1/2_FR SUCCOFEED_1/2_FR_UL SUCCOFEED_1/2_LW	11_716-50-12-50	84201175	
			16_716-50-12-50	84201179	
			21_716-50-12-50	84201177	
			11_N-50-12-50	84201169	
			16_N-50-12-50	84201181	
21_N-50-12-50	84201173				
74_Z-0-12-17	84147227	SUCCOFEED_1/2 SUCCOFEED_1/2_FR SUCCOFEED_1/2_FR_UL SUCCOFEED_1/2_LW	11_716-50-12-100	84125745	
			21_716-50-12-100	84125740	
			11_N-50-12-100	84125756	
			21_N-50-12-100	84125770	
74_Z-0-23-21	85002265	SUCCOFEED_7/8 SUCCOFEED_7/8_FR	11_716-50-23-44	84069135	
			21_716-50-23-44	84069194	
			11_N-50-23-43	84124063	
			21_N-50-23-43	84124062	
74_Z-0-23-22	84147229	SUCCOFEED_7/8_LA SUCCOFEED_7/8_LA_FR SUCCOFEED_7/8_LW_LA	11_716-50-23-100	84124984	
			21_716-50-23-100	84124988	
			11_N-50-23-100	84125762	
			21_N-50-23-100	84125871	
74_Z-0-23-16	23007928	SUCCOFEED_7/8_HF	11_N-50-23-41	84024502	
			21_N-50-23-41	84024596	
74_Z-0-32-14	23010533	SUCCOFEED_1_1/4 SUCCOFEED_1_1/4_FR SUCCOFEED_1-1/4_LW	21_716-50-32-4	84116150	
			11_716-50-32-100	84127325	
			21_716-50-32-100	84127329	
			11_N-50-32-100	84132614	
			21_N-50-32-100	84132616	
					jacket stripping only
74_Z-0-42-14	23010534	SUCCOFEED_1_5/8 SUCCOFEED_1_5/8_FR SUCCOFEED_1_5/8_LA SUCCOFEED_1_5/8_LA_FR SUCCOFEED_1-5/8_LW_LA	21_716-50-42-4	84079305	
			11_716-50-42-100	84132564	
			21_716-50-42-100	84132566	
			11_N-50-42-100	84132618	
			21_N-50-42-100	84132620	
					jacket stripping only

Cable stripping tools

Manual stripping tool

Manual stripping tools		Cable type	Connector		Picture
Type no.	Item no.		Type no.	Item no.	
74_Z-0-12-100	84133923	SUCOFEEED_1/2 SUCOFEEED_1/2_FR SUCOFEEED_1/2_FR_UL SUCOFEEED_1/2_LW	11_716-50-12-100	84125745	
			21_716-50-12-100	84125740	
			11_N-50-12-100	84125756	
			21_N-50-12-100	84125770	
74_Z-0-23-100	84133924	SUCOFEEED_7/8_HF SUCOFEEED_7/8 SUCOFEEED_7/8_FR SUCOFEEED_7/8_LA SUCOFEEED_7/8_LA_FR SUCOFEEED_7/8_LW_LA	11_N-50-23-43	84124063	
			21_N-50-23-43	84124062	
			11_716-50-23-100	84124984	
			21_716-50-23-100	84124988	
			11_N-50-23-100	84125762	
			21_N-50-23-100	84125871	

Flaring tools

Flaring tools		Cable type	Connector		Picture
Type no.	Item no.		Type no.	Item no.	
74_Z-0-12-8	85006446	SUCOFEEED_1/2 SUCOFEEED_1/2_FR SUCOFEEED_1/2_FR_UL SUCOFEEED_1/2_LW	11_716-50-12-50	84201175	
			16_716-50-12-50	84201179	
			21_716-50-12-50	84201177	
			11_N-50-12-50	84201169	
			16_N-50-12-50	84201181	
			21_N-50-12-50	84201173	
74_Z-0-32-15	84120843	SUCOFEEED_1_1/4 SUCOFEEED_1_1/4_FR SUCOFEEED_1-1/4_LW	21_716-50-32-4	84116150	
			11_716-50-32-100	84127325	
			21_716-50-32-100	84127329	
			11_N-50-32-100	84132614	
74_Z-0-42-15	84085074	SUCOFEEED_1_5/8 SUCOFEEED_1_5/8_FR SUCOFEEED_1_5/8_LA SUCOFEEED_1_5/8_LA_FR SUCOFEEED_1-5/8_LW_LA	21_716-50-42-4	84079305	
			11_716-50-42-100	84132564	
			21_716-50-42-100	84132566	
			11_N-50-42-100	84132618	
			21_N-50-42-100	84132620	

Cable stripping tools

for Quick-Fit and HUBER+SUHNER Eco connectors

Spare parts for cable stripping tools

H+S type	Item no.	Part description
74_Z-0-0-359	23014976	handle (for stripping tools)
74_Z-0-0-402	22652193	abrasive paper 320
74_Z-0-0-425	23001953	spanner AF 18 mm
74_Z-0-0-428	23001956	spanner AF 22 mm
74_Z-0-0-429	23001957	spanner AF 24 mm
74_Z-0-0-415	22652206	counter sink
74_Z-0-0-418	22652209	stanley knife
74_Z-0-0-420	22652211	steel brush
74_Z-0-0-422	22652213	steel measure 200 mm
74_Z-0-0-432	23002005	screw driver
74_Z-0-0-433	23002007	screw driver
74_Z-0-0-12	22642718	small metal saw
74_Z-0-0-434	23002166	monkey wrench
74_Z-0-0-297	22650531	blade (cutting foam dielectric, centre and outer conductor), 74_Z -0-23-21, 74_Z -0-23-22
74_Z-0-0-347	23000937	blade (cutting corrugated copper tube) for 74_Z-0-12-15, 74_Z-0-12-11
74_Z-0-0-349	23001008	blade (cutting corrugated copper tube) for 74_Z-0-9-15
74_Z-0-0-355	23008264	blade (cutting jacket) for 74_Z-0-32-14, 74_Z-0-23-16, 74_Z -0-23-21, 74_Z -0-23-22
74_Z-0-0-356	23010537	blade (cutting jacket) 74_Z-0-42-14
74_Z-0-0-416	22652207	allen wrench AF 2.5 mm/0.098 in. for 74_Z-0-9-15, 74_Z-0-12-15, 74_Z-0-32-14 and 74_Z-0-42-14
74_Z-0-0-423	23000311	allen wrench AF 4 mm/0.157 in. for removing the BIT adapter



Spuma – flexible, low-loss RF cables



The Spuma product family provides highly flexible cable solutions and stands for its extremely low loss. These cables are free of halogen and offer excellent electrical performance, especially an outstanding return loss (VSWR). HUBER+SUHNER Spuma cables are designed for applications up to 6 GHz and offer great opportunities in different industries, including railway, defense, communication and others. Spuma products can also be used as drop-in replacement for LMR® (LMR® is a brand of Times Microwave Inc.).

Features

- Very low loss up to 6 GHz
- LSFH (flame retardant) types
- Excellent return loss (VSWR)
- High flexibility

Spuma – flexible, low-loss RF cables

Spuma

Attenuation

Typical values at 20 °C ambient temperature and sea level

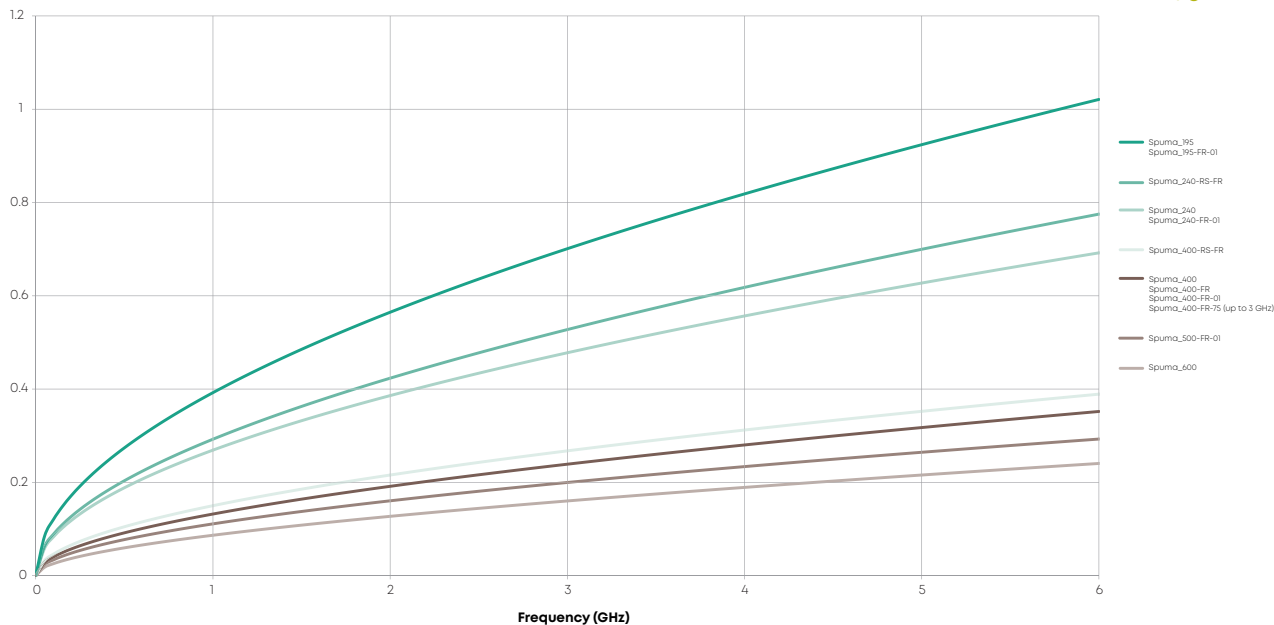

CW power

Max. values at 40 °C ambient temperature and sea level

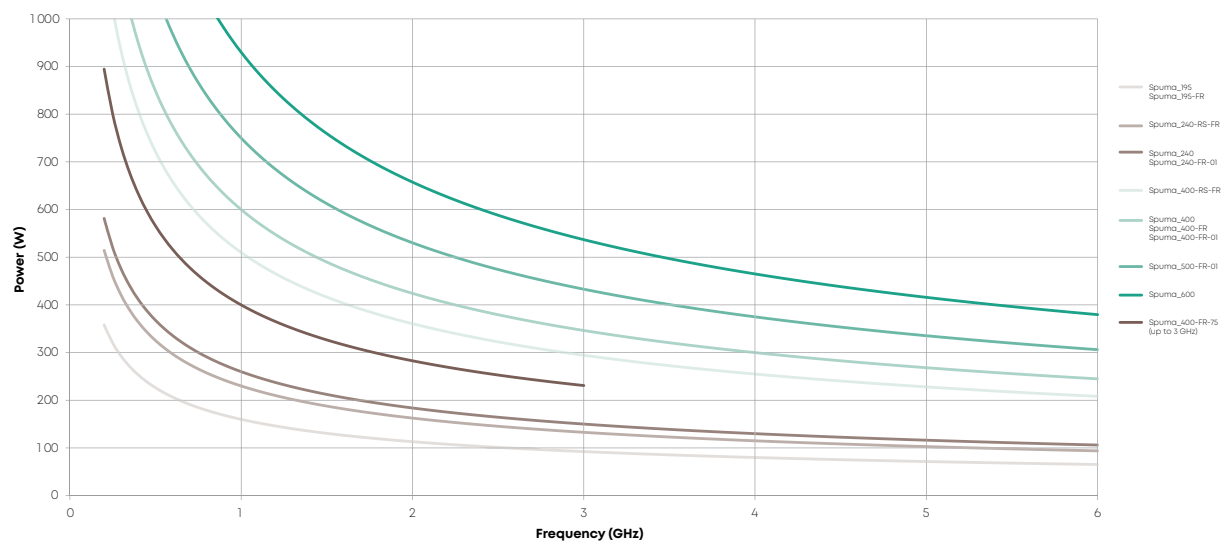

Spuma – flexible, low-loss RF cables

Portfolio overview



Spuma + Spuma FR



		Spuma_195 84151727	Spuma_195-FR-01 85021562	Spuma_240 84151737	Spuma_240-FR-01 85021563	Spuma_240-RS-FR 85089188	Spuma_400 84102703	Spuma_400-FR-01* 84132035	Spuma_400-RS-FR 85089191	Spuma_500-FR-01 85021564	Spuma_600 84151738	Spuma_400-FR-75 85022187
Construction												
1 Centre conductor	Cu wire
	Al/Cu wire					
	Cu low loss strand					.			.			
2 Dielectric	Foamed PE
3 Inner shield	Al-PES foil
4 Outer shield	Tin plated copper braid
5 Jacket	PE	
	LSFH	
	TPU					.			.			
	Diameter (mm)	4.95	4.98	6.15	6.17	6.17	10.3	10.3	10.3	12.8	15	10.3
Diameter (in)	0.195	0.196	0.242	0.243	0.243	0.404	0.404	0.404	0.503	0.590	0.404	
Electrical												
Impedance	Ω	50 +/-2										75 +/-3
Operating frequency	GHz	< 6										3
Screening effectiveness up to max. op. frequency	dB	> 90										
Attenuation at max. operating frequency	dB/m	1.02	0.69		0.78	0.35		0.39	0.29	0.24	0.25	
	dB/ft	0.31	0.21		0.24	0.11		0.12	0.09	0.07	0.12	
Power at 1 GHz, 40° C ambient temperature	W	160	240		230	600		510	750	930	400	
Mechanical												
Bending static	mm	12.5	10	19	14	14	25	25	25	34	38	25
	in	0.49	0.39	0.75	0.55	0.55	0.98	0.98	0.98	1.34	1.50	0.98
Bending repeated	mm	50	40	60	53	53	100	100	100	130	152	100
	in	1.97	1.57	2.36	2.09	2.09	3.94	3.94	3.94	5.12	5.98	3.94
Environmental												
Operating temperature	°C	-40 to +85										
Installation temperature	°C	-20 to +60										
Halogen-free	
RoHS	2011/65/EC
CPR		Fca	Eca	Fca	B2ca	**	Fca	Cca	**	Eca	Fca	**
Railway approvals	EN 45545-2		HL3		HL3	HL2		HL3	HL2	HL3		HL3
	NFPA-130	

* UL recognised alternative available: Spuma_400-FR (84040210) **To be tested on request

Spuma – flexible, low-loss RF cables



Cable type	Connector pattern	Cable type							
		Spuma_195 Spuma_195-FR-01	Spuma_240 Spuma_240-FR-01	Spuma_240-RS-FR	Spuma_400 Spuma_400-FR Spuma_400-FR-01	Spuma_400-RS-FR	Spuma_500-FR-01	Spuma_600	Spuma_400-FR-75
Cable group		X27	X28	X34	U30	X32	X31	X29	X33
7/16	11		.		.			.	
	16				.	.			
	24				.				
BNC	11			
	16				
	21	.							
N	11	
	16	
	21	
QMA	11		.	.					
	16		.	.					
	21		.						
QN	11		
	16		
	24		
XQN	11		.	.					
SMA	11			
	16			
	21	.	.						
TNC	11			
	16			
	21	.	.						
	24	.	.						

11	straight cable plug (male)	16	right angle cable plug (male)
21	straight cable jack (female)	24	straight panel bulkhead cable jack (female)



Detail view Spuma_400-RS-FR showing patented Rotary Swaging technology

Lightning protectors



Four decades of experience in developing and manufacturing coaxial lightning EMP and NEMP protectors are the foundation of the current HUBER+SUHNER RF-protection portfolio. Our products are designed to meet the stringent requirements of the RF/microwave, telecommunications and wireless industry and cover civil, security and defense applications. An extensive high-voltage impulse laboratory has been established to verify our designs in accordance with the valid international lightning, surge and NEMP standards. Important inventions are covered by worldwide patents.

Features

- Broadband designs
- Excellent RF performance
- High lightning current handling capability
- Low residual energy
- PIM optimised
- High CW and PIP power rating

Benefits

- Elevates system availability
- Lowers operational risk
- Lightning protectors perform the same before and after rated lightning pulses
- Best suited for outdoor installations
- Easy installation

How to select the right protector

Application

- Quarter wave lightning EMP protectors for high power and low PIM applications without DC continuity
- Broadband gas discharge tube (GDT) protectors for single channel or low power applications with DC continuity
- Hybrid GDT protectors for multiple channel, high power and low PIM applications with DC continuity
- Hybrid GDT protectors with bias-T to support active electronics with DC on top of the mast
- Optimised for outdoor installations



Important decision criteria

To find the most appropriate lightning EMP protector we guide you through the following list of criteria to evaluate the specific application requirements.

The first four evaluation criteria items are the most important.

1. DC continuity for powering of remote equipment
 - DC supply voltage
2. Frequency range
 - Operating band
 - AISG band
 - Telemetry band
3. Passive intermodulation requirements
4. RF power maximum
 - Continuous wave
 - Peak power
5. Protection requirements
 - Surge current handling capability
 - Residual pulse energy/voltage
6. RF requirements
 - Return loss (RL)
 - Insertion loss (IL)
7. Connector interfaces
8. Mounting/grounding requirements
 - Bulkhead mount
 - Screw mount
9. Environmental requirements
 - IP rating
10. Material requirements
11. Selection of the gas discharge tube for GDT lightning EMP protectors according the RF power

These criteria shall be considered with the provided selection flow chart next page. Product details are listed in this catalogue and further information can be found on the related product detail specification/data sheet.

For any support contact HUBER+SUHNER, hubersuhner.com or your local representative.

Selection flow chart for HUBER+SUHNER lightning protectors

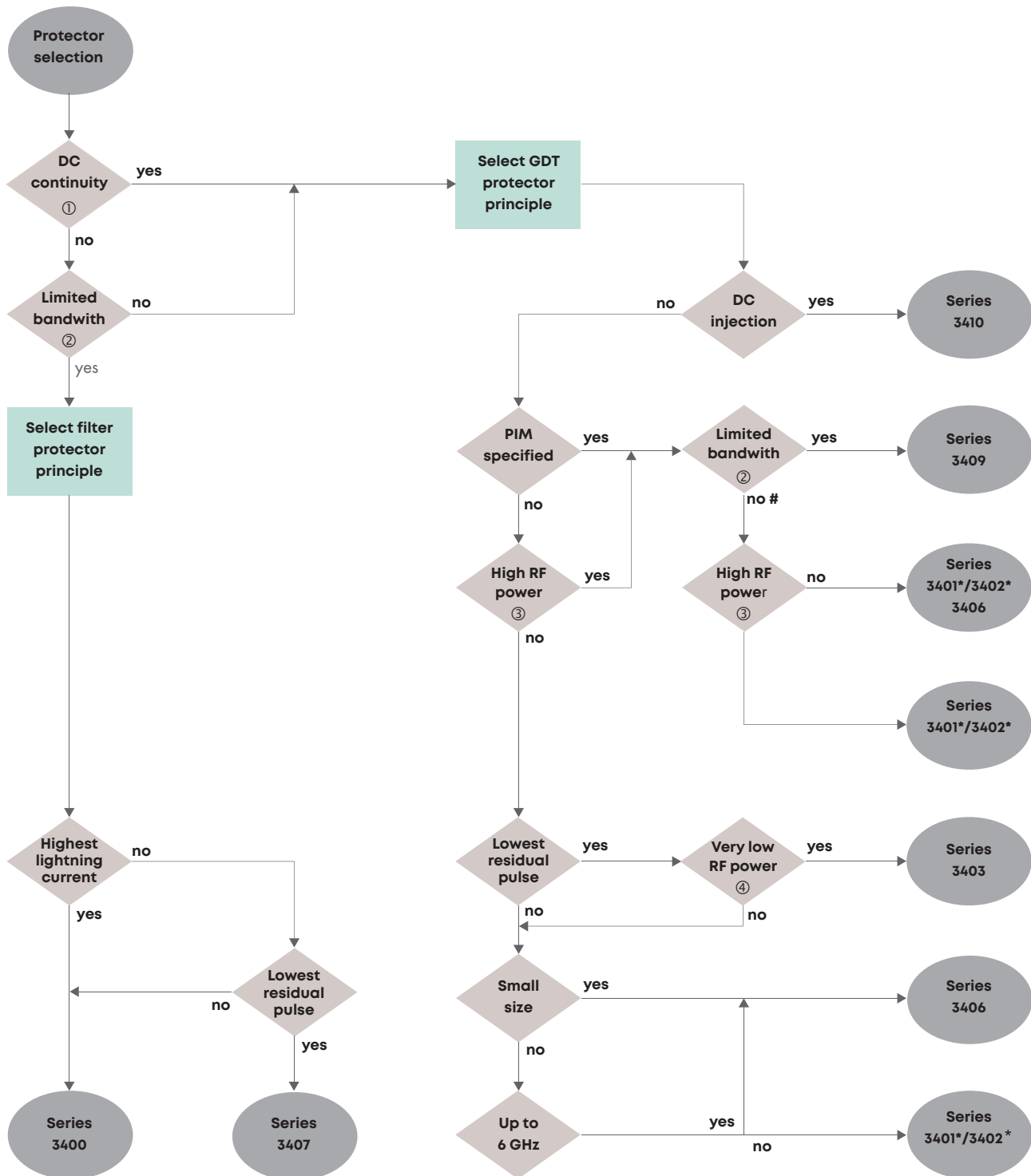

Notes

- 1 DC continuity DC can be supplied on the centre conductor for remote powering
- 2 Limited bandwidth no broadband operation only specific frequency bands can be transmitted
- 3 High RF power application with more than 1 kW (CW) transmission power
- 4 Very low RF power application with less than 50 W (CW) transmission power
- # No protector solution available featuring broadband operation and low PIM
- * Specific GDT has to be selected according to the transmitted RF power and DC supply voltage

Lightning protectors

Broadband lightning protectors



	Quarter wave shorting stub protectors				
	Series 3400				
					
Type no.	3400.17.0428	3400.17.0431	3400.31.0001	3400.41.0267	3400.41.0266
Frequency range (MHz)	2000 to 6000	690 to 2200	690 to 2700	690 to 2690	690 to 2690
Return loss (dB)	≥ 20	≥ 24	≥ 24	≥ 26	≥ 28
Insertion loss (dB)	≤ 0.2	≤ 0.15	≤ 0.1	≤ 0.1	≤ 0.1
Supports AISG at	–	–	–	–	–
RF Interface – unprotected/protected side	N male/ female	N male/ female	4.3-10 male/ 4.3-10 female	7/16 male/female	7/16 male/female
DC interface	–	–	–	–	–
PIM 3rd order (dBc)	–	≤ -150	≤ -160	≤ -160	≤ -160
RF power (CW) max. (W)	≤ 300	≤ 500	≤ 1500	≤ 1500	≤ 1500
RF power (PIP) max. (kW)	–	25	25	25	25
Max. DC voltage	no DC	no DC	no DC	no DC	no DC
Surge current (8/20 μs) – single pulse (kA) – multiple pulses (kA)	25 50	50 50	100 80	100 80	100 80
Residual energy (typ.) (μJ) 4 kV 1.2/50 μs; 2 kA 8/20 μs	0.2	10	11	11	11
Ingress protection rating	IP68	IP67	IP67	IP67	IP67

Order information					
Item no.	84048180	84080266	85020284	84150644	84143443
Type no.	3400.17.0428	3400.17.0431	3400.31.0001	3400.41.0267	3400.41.0266

Lightning protectors

Broadband lightning protectors



	Gas discharge tube protectors		
	Hybrid GTD series 3409		
			
Type no.	3409.31.0001	3409.41.0090 ¹⁾	3409.41.0092
Frequency range (MHz)	690 to 2700	690 to 2690	690 to 2690
Return loss (dB)	≥ 24	≥ 28	≥ 26
Insertion loss (dB)	≤ 0.1	≤ 0.1	≤ 0.1
Supports AISG at	2.176	2.176	2.176
RF Interface – unprotected/protected side	4.3-10 male/ 4.3-10 female/	7/16 male/female	7/16 male/female
DC interface	–	–	–
PIM 3rd order (dBc)	≤ -160	≤ -160	≤ -160
RF power (CW) max. (W)	≤ 1500	≤ 1500	≤ 1500
RF power (PIP) max. (kW)	25	25	25
GDT	replaceable	replaceable	replaceable
Max. DC voltage (V)	≤ 48	9071.99.0548 (90 V) ≤ 48	9071.99.0548 (90 V) ≤ 48
Surge current (8/20 μs) – single pulse (kA) – multiple pulses (kA)	30 20	30 20	30 20
Residual energy (typ.) (μJ) 4 kV 1.2/50 μs; 2 kA 8/20 μs	350	350	350
Ingress protection rating	IP67	IP67	IP67

Order information			
Item no.	85020334	84142698	84150561
Type no.	3409.31.0001	3409.41.0090 1)	3409.41.0092 1)

¹⁾ AISG = antenna interface standards group 

Lightning protectors

GPS lightning protectors

Application

- Fine protector hybrid technology to protect GPS electronics

Characteristics and specialities

- Very low residual pulse energy
- Full lightning protection (20 kA ; 8/20 μ s)
- DC bypass function
- Easy bulkhead installation

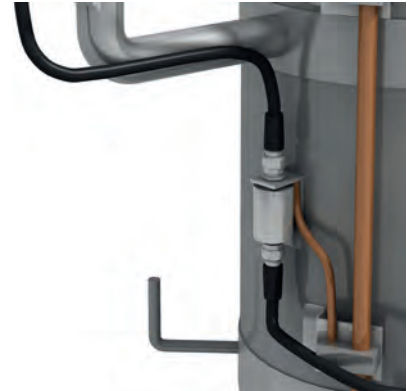

		Fine protectors hybrid technology	
		Series 3403	
			
Type no.		3403.17.0060	3403.17.0063
Frequency range		800 to 2500 MHz	
Return loss		≥ 26 dB	
Insertion loss		≤ 0.3 dB	
RF Interface – unprotected/protected side		N female/female	N male/female
DC bypass voltage other voltage on request		≤ 6 V	
DC bypass current		≤ 4 A	
Surge current (8/20 μ s) – single pulse – multiple pulses		20 kA 10 kA	
Residual energy (typ.) 4 kV 1.2/50 μ s; 2 kA 8/20 μ s		6 μ J	
Ingress protection rating		IP67	
Order information			
Item no.		84030303	84038163
Type no.		3403.17.0060	3403.17.0063

Lightning protectors

Broadband lightning protectors



Gas discharge tube protectors		
Series 3402		
		
Type no.	3402.41.A 1)	3402.17.0089
Frequency range (MHz)	DC to 2500	DC to 2500
Return loss	≥ 20 dB	≥ 20 dB
Insertion loss	≤ 0.2 dB	≤ 0.2 dB
RF Interface – unprotected/protected side	7/16 female/ female	N female/ female
RF power (CW) max.	dependant on GDT	dependant on GDT
GDT	replaceable not included	replaceable, not included
Max. DC voltage	dependant on GDT	dependant on GDT
Surge current (8/20 μs) – single pulse – multiple pulses	30 kA 20 kA	30 kA 20 kA
Residual energy (typ.) 4 kV 1.2/50 μs; 2 kA 8/20 μs	350 μJ	350 μJ
Ingress protection rating	IP67	IP65

Order information		
Item no.	22642813	84102779
Type no.	3402.41.A	3402.17.0089

Lightning protectors

Broadband lightning protector

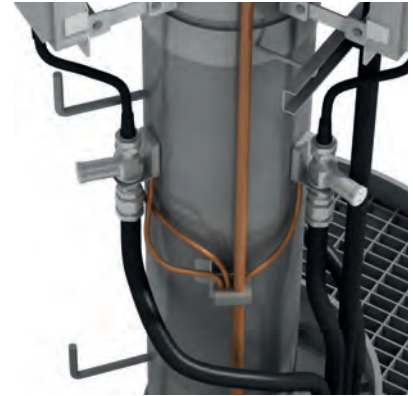

Gas discharge tube protectors								
Series 3406								
Type no.	3406.17.0009			3406.17.0012			3406.17.0027	3406.17.0028
Frequency range (MHz)	0 to 6000	0 to 5600	5600 to 5800	0 to 6000	0 to 5600	5600 to 5800	DC to 4000	
Return loss (dB)	≥ 15 dB	≥ 20 dB	≥ 18.5 dB	≥ 15 dB	≥ 20 dB	≥ 18.5 dB	≥ 20	
Insertion loss (dB)	≤ 0.3	≤ 0.2	≤ 0.2	≤ 0.3	≤ 0.2	≤ 0.2	≤ 0.2	
RF Interface – unprotected/protected side	N female/ N female			N male/ N female			N female/ female	N male/ female
RF power (CW) max. (W)	≤ 50			≤ 50			≤ 21	
GDT	not replaceable, fix installed (90 V)			not replaceable, fix installed (90 V)			not replaceable, fix installed (90 V)	
Max. DC voltage (V)	60			60			60	
Surge current (8/20 μs) – single pulse (kA) – multiple pulses (kA)	10 5				10 5	10 5		
Residual energy (typ.) (μJ) 4 kV 1.2/50 μs; 2 kA 8/20 μs	250			250			250	
Ingress protection rating	IP67			IP67			IP68	

Order information				
Item no.	23017636	23026117	84041874	84041875
Type no.	3406.17.0009	3406.17.0012	3406.17.0027	3406.17.0028

Lightning protectors



Broadband lightning protectors



	Fine protector hybrid technology Series 3403
	
Type no.	3403.17.0069
Frequency range	2.5 to 400 MHz
Ethernet cabling standard	≥ 26 dB
Insertion loss	≤ 0.25 dB
RF Interface – unprotected/ protected side	N female/ female
PoE acc. IEEE 802.3 at	≤ 50 W
GDT	not replaceable, fix installed (90 V)
Max. DC voltage	≤ 60 V
Surge current (8/20 μs) – single pulse – multiple pulses	10 kA 8 kA
Residual energy (typ.) 4 kV 1.2/50 μs; 2 kA 8/20 μs	60 μs
Ingress protection rating	IP67

Order information

Item no.	84144468
Type no.	3403.17.0069

	Filter protectors Series 3407	
		
Type no.	3407.17.0086	3407.41.0051
Frequency range (MHz)	690 to 2700	690 to 2700
Return loss (dB)	≥ 26	≥ 23
Insertion loss (dB)	≤ 0.15	≤ 0.1
Supports AISG at	–	–
RF Interface – unprotected/ protected side	N female/ female	7/16 male/ female
DC interface	–	–
PIM 3rd order (dBc)	≤ -150	≤ -155
RF power (CW) max. (W)	≤ 260	≤ 500
RF power (PIP) max. (kW)	–	–
Max. DC voltage	no DC	no DC
Surge current (8/20 μs) – single pulse (kA) – multiple pulses (kA)	20 10	25 20
Residual energy (typ.) (μJ) 4 kV 1.2/50 μs; 2 kA 8/20 μs	0.001	0.03
Ingress protection rating	IP68	IP67

Order information

Item no.	84099040	84142087
Type no.	3407.17.0086	3407.41.0051

Lightning protectors

Cellular backhaul lightning protectors





Application

- Protection of backhaul equipment with RJ45 interfaces

Characteristics and specialities

- Data line protector supports cat. 5 class D and alternatively Gigabit Ethernet cat. 6, class E
- Indoor and outdoor versions available
- PoE (IEEE 802.3 at)



	Data line protectors			
	Series 3414			
				
Application	for indoor	for outdoor	for indoor	for outdoor
Type no.	3414.99.0001	3414.99.0008	3414.99.0021	3414.99.0022
Frequency range	DC to 100 MHz		DC to 250 MHz	
Ethernet cabling standard	cat. 5; class D channel link		cat. 6; class E channel link	
RF Interface – unprotected/protected side	RJ 45 female/female (8 pins)		RJ 45 female/female (8 pins)	
PoE acc. IEEE 802.3 at	✓		✓	
GDT	not replaceable, fix installed		not replaceable, fix installed	
Max. DC voltage	58 V between pairs		58 V between pairs	
Total (all lines to PE) (shield PE)	10 kA 6 kA		10 kA shield (connected) to PE	
Ingress protection rating	IP20	IP68	IP20	IP68

Order information				
Item no.	23033695	84014284	84108159	84122191
Type no.	3414.99.0001	3414.99.0008	3414.99.0021	3414.99.0022

Lightning protectors

DC block

Application

- Blocking of DC (galvanic isolation in centre conductor)
- Blocking or reducing of switching transients on transmission lines

Characteristics and specialities

- Broadband operation for all cellular bands
- Max. operation DC voltage ≤ 1 kV
- Isolation at 1 kHz ≥ 80 dB
- Robust and compact
- Low weight
- IP67 rated



	DC block		DC-DC block	
	Series 9077			
				
Type no.	9077.41.0035		9077.41.0036	
Frequency ranges	350 to 3000 MHz	650 to 2700 MHz	360 to 3000 MHz	650 to 2700 MHz
Return loss	≥ 20 dB	≥ 26.5 dB	≥ 20 dB	≥ 26 dB
Insertion loss	≤ 0.1 dB		≤ 0.1 dB	
RF Interface – unprotected/protected side	7/16 male/female		7/16 male/female	
RF power (CW) max.	370 W		750 W	
RF power (PIP) max.	25 kW		25 kW	
PIM 3rd order	≤ -160 dBc typ.		≤ -160 dBc typ.	
DC blocking voltage on centre conductor	≤ 1 kV		≤ 1 kV	
Isolation at 100 kHz	≥ 40 dB		≥ 40 dB	
at 10 kHz	≥ 60 dB		≥ 60 dB	
at 1 kHz	≥ 80 dB		≥ 80 dB	
Ingress protection rating	IP67		IP67	

Order information

Item no.	85007661	84082135
Type no.	9077.41.0036	9077.41.0035

Lightning protectors

Gas discharge tube (GDT)

The best fitting gas discharge tube (GDT) can be selected according to the applied continuous RF power. If a DC signal is superimposed on the RF transmission line follow the guidelines given in the lightning protection catalogue. IP67 rated.



Type no.	Item no.	U_{Zstat}	$U_{Zdyn max.}$	$I_s 8/20 \mu s$	$I_{SG} 8/20 \mu s$	U_{ARC}	Dim. (mm)
		(V)	(V)	(kA)	(kA)	(V)	
9071.99.0547	23011010	230 ± 15 %	675	20	30	10 to 15	6 × 8
9071.99.0548	23034582	90 ± 20 %	500	20	30	10 to 15	6 × 8
9071.99.0549	23039069	350 ± 15 %	875	20	30	10 to 15	6 × 8
9071.99.0550	23039070	470 ± 15 %	1000	20	30	10 to 15	6 × 8
9071.99.0551	23024119	600 ± 15 %	1100	20	30	10 to 15	6 × 8



Diagramm of permissible RF power (CW or PEP) for 50 Ω systems.

Lightning protectors

Self-extinguishing gas discharge tube with automatic recovery (Semper)

Features and benefits

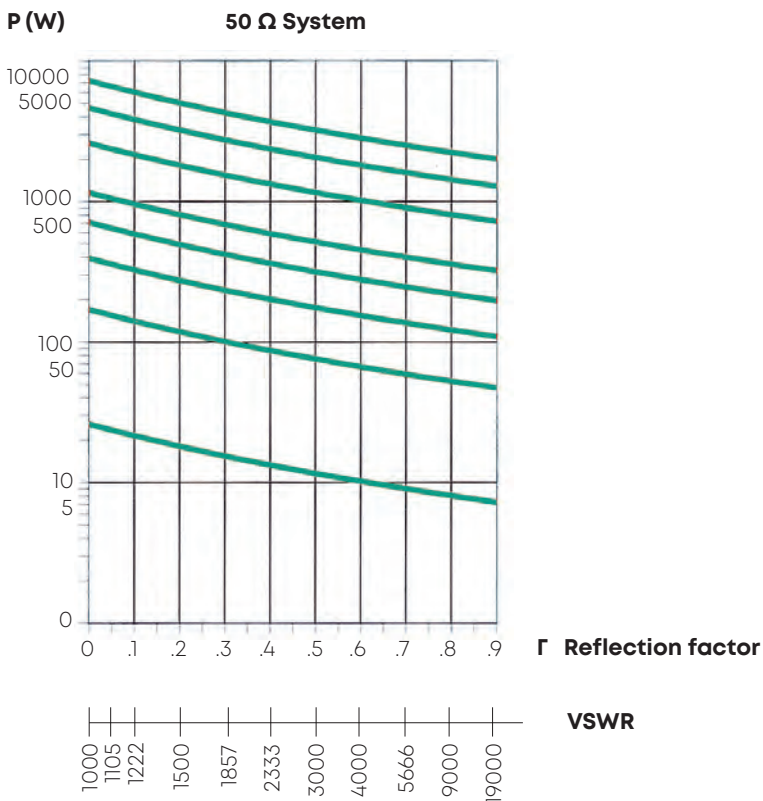
- Self-extinguishing gas discharge tube with automatic recovery
- Extinguishing under any coaxial line condition including:
 - Malfunction of electronic fused DC supplies
 - Malfunction of RF line monitoring
 - Absence of any such mechanism
- Can be employed for any HUBER+SUHNER GDT protector with exchangeable gas tube
- Field replacement allows cost-effective system upgrades
- Product options ensure availability for any application
- Higher safety
- Negligible system downtime



Semper GDT units for retrofit and replacement for series 3401 and 3402

Type no.	Item no.	U_{zstat}	$U_{zdyn} \text{ max.}$	$I_s \text{ 8/20 } \mu\text{s}$	$I_{SG} \text{ 8/20 } \mu\text{s}$	U_{ARC}
		(V)	(V)	(kA)	(kA)	(V)
9071.99.0647	84010427	230 ± 15 %	675	20	30	10 to 15
9071.99.0648	84015426	90 ± 20 %	500	20	30	10 to 15
9071.99.0549	84017487	350 ± 15 %	875	20	30	10 to 15
9071.99.0550	84017488	470 ± 15 %	1000	20	30	10 to 15
9071.99.0551	84017489	600 ± 15 %	1100	20	30	10 to 15

Semper GDT units for retrofit and replacement for series 3409

Type no.	Item no.	U_{zstat}	$U_{zdyn} \text{ max.}$	$I_s \text{ 8/20 } \mu\text{s}$	$I_{SG} \text{ 8/20 } \mu\text{s}$	U_{ARC}
		(V)	(V)	(kA)	(kA)	(V)
9071.99.0747	84014462	230 ± 15 %	675	20	30	10 to 15
9071.99.0748	84015401	90 ± 20 %	500	20	30	10 to 15

Sectional view of Semper GDT module

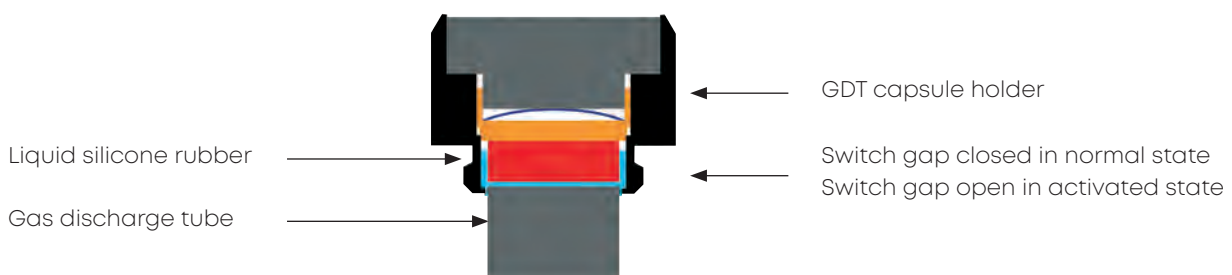



Grounding kits and accessories



We offer a large selection of advanced products, which are rich in exclusive features and highly appreciated by the operators of leading companies in the sector because we provide total fastening safety along with practical and easy mounting.

Grounding kits and accessories

Grounding kits

Application

HUBER+SUHNER series 9076 grounding kits enable reliable grounding of today's usual corrugated copper tube and RG cables for radio transmitter antenna installations.

Features

- Quick and easy installation
- No loose piece parts
- Low contact transition resistance (1 mΩ max.)
- Grounding cable AWG6 (16 mm²)
- Current handling capability 100 kA 8/20 μs, 25 kA 10/350 μs
- Waterproof IP67
- Corrosion resistant



Material data

Component part	Material
Metal mounting parts	stainless steel
Contact part	copper
Gasket	EPDM

Grounding kit N-style

Straight grounding cable connection
Right angle to corrugated copper tube cable

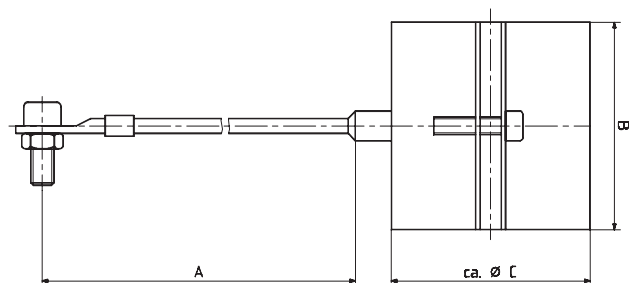

HUBER+SUHNER type	Item no.	For cable size Sucofeed, Andrew, Nokia, Kabelmetal, RFS, Eupen, etc.	A (mm)	B (mm)	C (mm)	Stripping length	Grounding screws
9076.99.N012-50	84124423	1/2"	500	50	32	26	M8
9076.99.N013-50	84124422	1/2" highflex	500	50	32	26	M8
9076.99.N078-50	84069990	7/8"/7/8" highflex	500	50	44	26	M8
9076.99.N114-50	84069991	1 – 1/4"	500	50	59	26	M8
		1/2"	840	50	32	26	M8
		1/2" highflex	840	50	32	26	M8
9076.99.N014	23015053	1/4", RG_213/214 ¹⁾	840	50	28	26	M8
9076.99.N038	23012644	3/8"	840	50	28	26	M8
	23009966	7/8"/7/8" highflex	840	50	44	26	M8
		1 – 1/4"	840	70	59	26	M8
9076.99.N158	23012647	1 – 5/8"	840	70	69	30	M8

¹⁾ Including 3/8" highflex

Grounding kits and accessories

Grounding kit P-style

Parallel grounding cable connection
 Aligned to corrugated copper tube cable

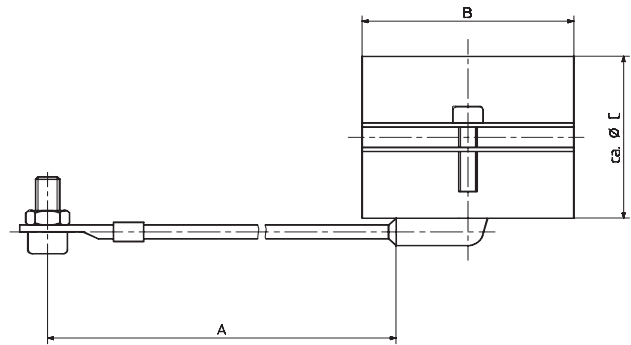

HUBER+SUHNER type	Item no.	For cable size Sucofeed, Andrew, Nokia, Kabelmetal, RFS, Eupen, etc.	A (mm)	B (mm)	C (mm)	Stripping length (mm)	Grounding screws
9076.99.P012	23011466	1/2"	840	50	32	26	M8
9076.99.P013	23012649	1/2" highflex	840	50	32	26	M8
9076.99.P014	23015054	1/4", RG_213/214 ¹⁾	840	50	28	26	M8
9076.99.P038	23012650	3/8"	840	50	28	26	M8

¹⁾ Including 3/8" highflex

Stripping dimensions

Concerning the necessary cable jacket length which has to be removed, refer the tables above, column „stripping length“. Select according to type number.

The mounting instruction is shipped with every kit.

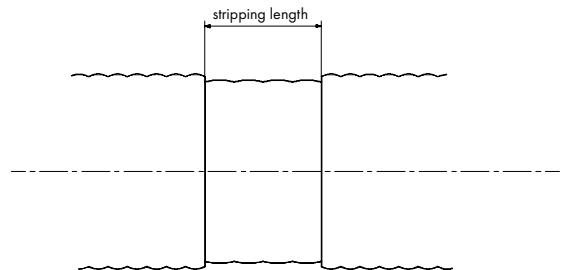

Grounding kits and accessories

Cold shrink tubes for additional protection

This special cold shrink tube reliably protects coaxial connectors against humidity and harsh environmental influences like icy conditions or a polluted atmosphere. It especially allows for outdoor feeder line installations in mobile communications and other wireless systems.

The simple and fast assembly of this cold shrink tube, by pulling out the supporting spiral, enables a reliable installation without special tools. After the assembly the cold shrink tube provides reliable protection by its continuous radial contact pressure.

Features

- Quick and easy installation without tool
- No torches or heat required
- Accommodates a wide range of cable sizes
- Good thermal stability
- Resists acids and bases, ozone and UV radiation
- Water resistant
- Application temperature (shrinking process) $-20\text{ }^{\circ}\text{C}/+ 50\text{ }^{\circ}\text{C}$
- Working temperature $-20\text{ }^{\circ}\text{C}/+ 130\text{ }^{\circ}\text{C}$



Type no.	Item no.	Material	For connector pair
73_Z-0-0-678/---_E	84062968	silicone EPDM ¹⁾	1/2" HF – 1/2" HF 1/2" HF – 1/2" 1/2" HF – 7/8" 1/2" – 1/2" 1/2" – 7/8" 7/8" – 7/8"
73_Z-0-0-339/---_E	22658885		1/2" HF – 1 1/4" 1/2" HF – 1 5/8" 1/2" – 1 1/4" 1/2" – 1 5/8" 7/8" – 1 1/4" 7/8" – 1 5/8"

¹⁾ At temperature below 0 °C shrinking process can be supported by hand warmth.

Power splitters



The RF power splitters are low loss reactive splitters for the distribution of RF signals to radio transceiver antenna systems and radiating cables. The RF power is equally distributed to all outputs with excellent amplitude and phase balance.

A broad range of power splitters with N and DIN 7/16 connectors has been designed to split even high power multi-carrier signals of all existing mobile phone systems. Multiband units simplify logistics for OEMs and multi-system operators.

Power splitters

N types with frequency range 694 to 3800 MHz



Type no.	5502.17.0050
Item no.	85029265
Split	2 way
Frequency	694 to 3800 MHz
Input port	N female
Output port	N female
Return loss (input)	min. 20 dB
Insertion loss	max. 0.2 dB
PIM at 2 × 43 dBm carrier power	< -161 dBc
Average power	300 W
IP rating	IP67
Operating temperature range	-35 to +85 °C/-31 to +185 °F
Weight	0.21 kg
Mounting hardware	2 clips supplied

N types with frequency range 380 to 2700 MHz



Type no.	5501.17.0030	5501.17.0031
Item no.	85029258	85029259
Split	2 way	3 way
Frequency	380 to 2700 MHz	380 to 2700 MHz
Input port	N female	N female
Output port	N female	N female
Return loss (input)	min. 19 dB	min. 19 dB
Insertion loss	typ. 0.1 dB	typ. 0.1 dB
PIM at 2 × 43 dBm carrier power	< -155 dBc	< -155 dBc
Average power	300 W	300 W
IP rating	IP67	IP67
Operating temperature range	-35 to +85 °C/-31 to +185 °F	
Weight	0.33 kg	0.37 kg
Mounting hardware	2 clips supplied	

Power splitters

DIN 7/16 types with frequency range 694 to 3800 MHz for LTE



Type no.	5501.31.0020
Item no.	85075304
Split	2 way
Frequency	380 to 2700 MHz
Input port	4310 female
Output port	4310
Return loss (input)	min. 17 dB
Insertion loss	typ. 0.1 dB
PIM at 2 × 43 dBm carrier power	-161 dBc
Average power	300 W
IP rating	IP67
Operating temperature range	-40° to +85°
Weight	0.65 Kg
Mounting hardware	2 clips supplied

DIN 7/16 types with frequency range 380 to 2700 MHz



Type no.	5501.31.0030
Item no.	85075306
Split	3 way
Frequency	380 – 2700 MHz
Input port	4310 female
Output port	4310 female
Return loss (input)	min. 17 dB
Insertion loss	typ. 0.1 dB
PIM at 2 × 43 dBm carrier power	-161 dBc
Average power	300 W
IP rating	IP67
Operating temperature range	-40° to +85°
Weight	0.85 kg
Mounting hardware	2 clips supplied

High power Low PIM Loads for stationary use

HUBER+SUHNER developed a stepped portfolio of compact Low PIM Loads starting at 30 Watt up to 150 Watt. This provides the flexibility and freedom you need for designing a DAS network. The modularity accommodates economics without compromising quality and performance.

Application

In a high power wireless infrastructure, the deployment of low PIM components is crucial in regards to the mobile network's availability and service quality.



Low PIM loads, 50 Ω

HUBER+SUHNER type	Item no.	Interface	Frequency (GHz)	Power (W)	PIM (dBc) ¹⁾
6530.41.0001	85032253	7/16 female	0.69 to 2.7	30	≤ -160 (typ. -165)

¹⁾ Two-tone test at 2 x 43 dBm/2 x 20 W carrier

Adaptors

These low PIM adaptors have been specially developed for IBC/DAS/small cell grade applications where passive intermodulation requirements are crucial.



Intermodulation adaptors, 50 Ω

Interface 1	Interface 2	PIM (dBc) ¹⁾	HUBER+SUHNER type	Item no.
7/16 male	NEX10 female	≤ -166 **	33_716-NEX10-50-1/133_WE	85092476
NEX10 male	7/16 female	≤ -166 **	33_NEX10-716-50-X1/133_WE	85092478
4.3-10 male	7/16 male	≤ -155 *	32_4310-716-50-X2/133_WE	85031321
4.3-10 male	7/16 female	≤ -155 *	33_4310-716-50-X2/133_WE	85031408
7/16 male	4.3-10 female	≤ -155 *	33_716-4310-50-2/133_WE	85031552
7/16 female	7/16 female	≤ -155 *	31_716-50-0-5/133_WE	85031221
7/16 male	7/16 male	≤ -155 *	32_716-50-0-5/133_WE	85031354
7/16 male	7/16 female	≤ -155 *	33_716-50-0-5/133_WE	85031578
N female	7/16 female	≤ -155 *	31_N-716-50-4/133_WE	85031263
N male	7/16 male	≤ -155 *	32_N-716-50-5/133_WE	85026230
7/16 male	N female	≤ -155 *	33_716-N-50-9/133_WE	85026231
N male	7/16 female	≤ -155 *	33_N-716-50-5/133_WE	85031611

¹⁾ Two-tone test at 2 x 43 dBm / 2 x 20 W carrier

* typ. -160 dBc

** typ. -171 dBc

Low PIM T+M grade components



To improve or guarantee the data throughput or the system capacity in existing or new cell site networks it is vital to have access to precise test and measurement grade components which guarantee accurate and stable test results.

HUBER+SUHNER offers high performance adaptors for specific test and measurement tasks for analyzing cell site installations. The adaptors allows to accurately measure passive intermodulation (PIM) performance.

The components, such as adaptors, intermodulation standards, loads and test leads, offer a perfect range of complementary accessories to support the latest generation of portable PIM test equipment.

Low passive intermodulation adaptors

These low PIM adaptors have been specially developed for T+M grade applications in intermodulation test setups in the field where passive intermodulation requirements are crucial.

Features

- Outstanding intermodulation performance
- Non magnetic materials
- Excellent electrical contacts
- Reliable and repeatable intermodulation measurements



Intermodulation adaptors, 50 Ω

Interface 1	Interface 2	PIM (dBC) ¹⁾	Frequency (GHz)	HUBER+SUHNER type	Item no.
7/16 female	7/16 female	≤ -165	2.7	31_716-50-0-2/133_WE	22658136
7/16 male	7/16 male	≤ -165		32_716-50-0-2/133_WE	22658141
7/16 male	7/16 female	≤ -165		33_716-50-0-2/133_WE	22658193
7/16 female	N female	≤ -165	2.7	31_N-716-50-2/133_WE	22658137
7/16 male	N male	≤ -165		32_N-716-50-2/133_WE	22658140
7/16 male	N female	≤ -165		33_716-N-50-3/133_WE	22658823
7/16 female	N male	≤ -165		33_N-716-50-3/133_WE	22658217
7/16 female	QN female	≤ -155	2.7	31_QN-716-50-1/113_WE	23033269
7/16 male	QN male	≤ -155		32_QN-716-50-1/113_WE	23033643
7/16 male	QN female	≤ -155		33_716-QN-50-1/113_WE	23033644
7/16 female	QN male	≤ -155		33_QN-716-50-1/113_WE	23033550
7/16 female	4.1/9.5 female	≤ -165	2.7	31_4195-716-50-1/133_WE	22658138
7/16 male	4.3-10 male	≤ -166	2.7	32_4310-716-50-1/133_WE	85017233
7/16 female	4.3-10 female	≤ -166		33_4310-716-50-1/133_WE	85017237
7/16 male	4.3-10 female	≤ -166		33_716-4310-50-1/133_WE	85017213

¹⁾ Two-tone test at 2 × 43 dBm/2 × 20 W carrier

Passive intermodulation standards

Intermodulation standards are special adaptors which generates intermodulation products of a certain preset level. They are used to verify intermodulation test benches for an instant and/or long-term level stability monitoring. If the third-order intermodulation value, displayed by the test instrument, deviates from the specified value of the intermod standard, it indicates a general measurement uncertainty which may be caused by the test set-up rooting in one or several component or interconnection PIM sources.

Features

- High repeatability
- Each item delivered with measurement protocol
- Verification traceability via serial number



7/16, 50 Ω, connector configuration male to female

Frequency band MHz	PIM (dBc) ¹⁾ 3rd order intermodulation ²⁾	HUBER+SUHNER type	Item no.
900	-80	69_716-50-0-1/133_WE	22658219
900	-110	69_716-50-0-3/133_WE	22658221
1800	-80	69_716-50-0-5/133_WE	23003870
1800	-110	69_716-50-0-7/133_WE	23003872

¹⁾ Two-tone test at 2×43 dBm/ 2×20 W carrier

²⁾ IM3 ± 3 dB



TL-P – high flexible PIM test lead

HUBER+SUHNER TL-P product line is developed for indoor and outdoor applications where passive intermodulation (PIM) and return loss (RL) has to be tested. Its excellent PIM and RL performance makes this assembly perfect for the use in Test+Measurement applications. TL-P is based on a flexible cable which is optimised up to 4 GHz and protected with a steel armouring. The robust design is completed with a moulded protection between connector and cable. Field use requires flexible and ruggedised test equipment. TL-P is specially designed for this environment.

Features

- Highly flexible, tough and reliable design
- Designed for high mating cycles (> 2000)
- Produced under stringent manufacturing and quality standards
- Factory-made cable assemblies





TL-P – high flexible PIM test lead

Specifications

PIM (tested accord. IEC 62037-2)	≥ -117 dBm (-160 dBc)			
Return loss (up to L = 3.0 m)	1 GHz	2 GHz	3 GHz	4 GHz
	≤ -29 dB	≤ -26 dB	≤ -23 dB	≤ -19 dB
Shielding effectiveness	> -120 dB			
Temperature range	-15 up to 65 °C (operating) -10 up to 55 °C (installation)			
Bending radius (dynamic)	≥ 110 mm (4.3 inch)			

Choice of suitable products

Assemblies	Configuration	Length	Description	Material no.
	DIN 7/16 male – DIN 7/16 male	1.5 m 3.0 m	TL-P-11716-11716-01500-51 TL-P-11716-11716-03000-51	85027448 85027254
	DIN 7/16 male – N male	1.5 m 3.0 m	TL-P-11716-11N-01500-51 TL-P-11716-11N-03000-51	85027450 85027453
	4.3-10 male (hex.) – DIN 7/16 male	1.5 m 3.0 m	TL-P-11431X-11716-01500-51 TL-P-11431X-11716-03000-51	85029279 85029280

RF Feederline components selection guide

Quick-Fit connectors

Cable	Grounding kit		Connector		Assembling instruction	
	Type no.	Item no.	Type no.	Item no.		
SUCOFEEED_1/4_HF SUCOFEEED_1/4_HF_FR SUCOFEEED_1/4_HF_FR_UL			Use LISCA			
SUCOFEEED_3/8_HF SUCOFEEED_3/8_HF_FR SUCOFEEED_3/8_HF_FR_UL						
SUCOFEEED_1/2_HF SUCOFEEED_1/2_HF_FR SUCOFEEED_1/2_HF_FR_UL	9076.99.N013-50	84124422	11_716-50-9-9 16_716-50-9-5 21_716-50-9-9 11_N-50-9-9 16_N-50-9-6 21_N-50-9-9	22660309 23007298 22660310 22660311 23007299 22660312	DOC-0000179418	
SUCOFEEED_1/2 SUCOFEEED_1/2_FR SUCOFEEED_1/2_FR_UL SUCOFEEED_1/2_LW	9076.99.N012-50	84124423	11_716-50-12-50 16_716-50-12-50 21_716-50-12-50 11_N-50-12-50 16_N-50-12-50 21_N-50-12-50 11_4310-50-12-X2 11_4310-50-12-Y2 11_4310-50-12-Z2 21_4310-50-12-1	84201175 84201179 84201177 84201169 84201181 84201173 85020537 85021551 85021552 85029736	DOC-0000386367	
SUCOFEEED_7/8_HF	9076.99.N078-50	84069990	11_716-50-23-41 21_716-50-23-41 11_N-50-23-41 21_N-50-23-41	85010074 85010190 84024502 84024596	DOC-0000243751	
SUCOFEEED_7/8 SUCOFEEED_7/8_FR SUCOFEEED_7/8_LA SUCOFEEED_7/8_LA_FR SUCOFEEED_7/8_LW_LA	9076.99.N078-50	84069990	11_716-50-23-44 21_716-50-23-44 11_N-50-23-43 21_N-50-23-43	84069135 84069194 84124063 84124062	DOC-0000295365	
SUCOFEEED_1_1/4 SUCOFEEED_1_1/4_FR SUCOFEEED_1_1/4_LW	9076.99.N114-50	84069991	11_716-50-32-4 21_716-50-32-4	84116088 84116150	DOC-0000341341	
SUCOFEEED_1-5/8 SUCOFEEED_1-5/8_FR SUCOFEEED_1-5/8_LA SUCOFEEED_1-5/8_LA_FR SUCOFEEED_1-5/8_LW_LA	9076.99.N158	23012647	11_716-50-42-4 21_716-50-42-4	84079343 84079305	DOC-0000299051	

Manual stripping tools		Flaring tools		Automating rotation stripping tools	
Type no.	Item no.	Type no.	Item no.	Type no.	Item no.
				74_Z-0-9-15	23001006
		74_Z-0-12-8	85006446	74_Z-0-12-11	84147226
				74_Z-0-23-16	23007928
74_Z-0-23-100	84133924			For 7/8": 74_Z-0-23-21 For 7/8" LA: 74_Z-0-23-22	85002265 84147229
		74_Z-0-32-15	84120843	74_Z-0-32-14 jacket stripping only	23010533
		74_Z-0-42-15	84085074	74_Z-0-42-14 jacket stripping only	2301053

RF Feederline components selection guide

HUBER+SUHNER Eco connectors

Cable	Grounding kit		Connector		Assembling instruction
	Type no.	Item no.	Type no.	Item no.	
SUCOFEEED_1/2 SUCOFEEED_1/2_FR SUCOFEEED_1/2_FR_UL SUCOFEEED_1/2_LW	9076.99.N012-50	84124423	11_716-50-12-100	84125745	DOC-0000364681
			21_716-50-12-100	84125740	
			11_N-50-12-100	84125756	DOC-0000364683
			21_N-50-12-100	84125770	
SUCOFEEED_7/8_HF SUCOFEEED_7/8 SUCOFEEED_7/8_FR SUCOFEEED_7/8_LA SUCOFEEED_7/8_LA_FR SUCOFEEED_7/8_LW_LA	9076.99.N078-50	84069990	11_716-50-23-100	84124984	DOC-0000363432
			21_716-50-23-100	84124988	
			11_N-50-23-100	84125762	
			21_N-50-23-100	84125871	
SUCOFEEED_1_1/4 SUCOFEEED_1_1/4_FR SUCOFEEED_1_1/4_LW	9076.99.N114-50	84069991	11_716-50-32-100	84127325	DOC-0000364680
			21_716-50-32-100	84127329	
			11_N-50-32-100	84132614	
			21_N-50-32-100	84132616	
SUCOFEEED_1-5/8 SUCOFEEED_1-5/8_FR SUCOFEEED_1-5/8_LA SUCOFEEED_1-5/8_LA_FR SUCOFEEED_1-5/8_LW_LA	9076.99. N158	23012647	11_716-50-42-100	84132564	DOC-0000375031
			21_716-50-42-100	84132566	
			11_N-50-42-100	84132618	
			21_N-50-42-100	84132620	

Manual stripping tools		Flaring tools		Automating rotation stripping tools	
Type no.	Item no.	Type no.	Item no.	Type no.	Item no.
				74_Z-0-12-17	84147227
Preferred tool: 74_Z-0-23-100	84133924			For 7/8" and 7/8" HF: 74_Z-0-23-21 For 7/8" LA: 74_Z-0-23-22	85002265 84147229
		74_Z-0-32-15	84120843	74_Z-0-32-14 jacket stripping only	23010533
		74_Z-0-42-15	84085074	74_Z-0-42-14 jacket stripping only	2301053

Cell site connectivity

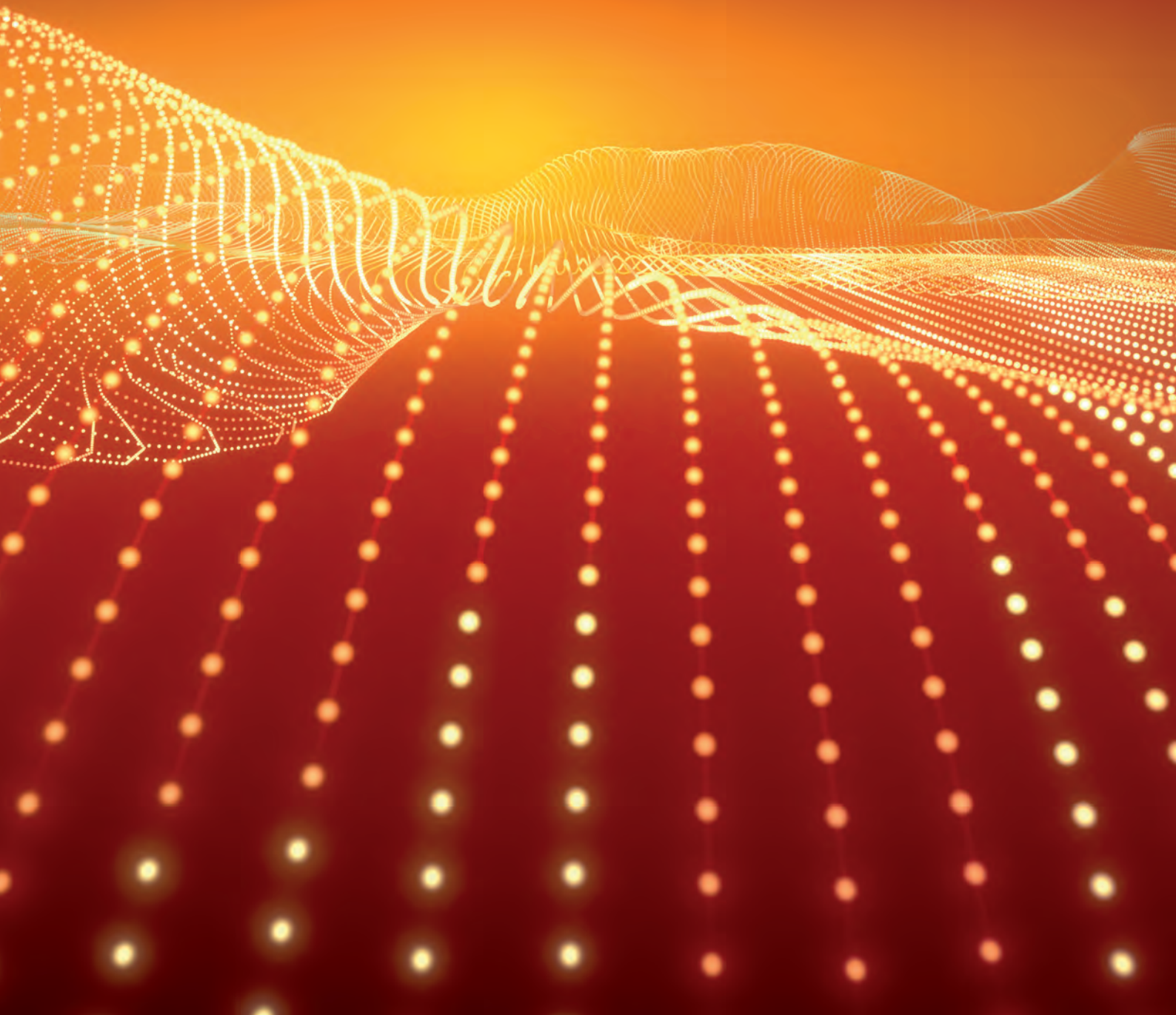

Solving network densification challenges in the X-haul

Deploying 5G and 4G

Across the world the rollout of the 5G network has started with mobile operators offering enhanced mobile broadband (including fixed wireless access) services. However, in many areas the mobile fiber network infrastructure already is at its maximum capacity even without the addition of 5G. To make things even more complicated, the requirements for capacity increase solutions is extremely diverse. In a mobile fiber infrastructure network there are hardly two sites a like where the capacity increase solutions need to be placed. Available space and power, humidity and temperature resilience, available fiber strands and number of required services to name only a few.

The HUBER+SUHNER optical access solution portfolio is specifically designed to cover these diverse requirements.

Active and passive transport

Both active and passive transport solutions have their advantages. Depending on the application and location either one could be the better suited than the other. This is exactly why the HUBER+SUHNER portfolio includes both. Even more so, the passive and active solutions are designed in such a way that they can easily be combined having an active device on one side and a passive on the other side of the transport link.

Simple upgrade path

The HUBER+SUHNER optical access portfolio at the core is based on WDM both for the active and passive solutions. WDM offers some great advantages over other optical transport and capacity increase technologies. Two of the biggest advantages are the possibility to grow as you pay and a cost effective upgrade path for future technologies.

Future proof

Despite the first 5G deployments having happened, there are still many uncertainties when it comes to 5G and what is to come. This is especially the case when it comes to the additional 5G services massive machine type communication (mMTC) and ultra-reliable and low-latency communication (uRLLC). For these services to make commercial sense for both operators and customers, converged 5G/4G front-, mid- and backhaul networks will become a necessity. The uncertainties hereby are the protocols that need to be supported (eCPRI, O-RAN, nFAPI, etc.) as well as timing and synchronisation requirements within the network (TSN, PTP, etc.).

As the HUBER+SUHNER optical access portfolio is based on WDM and the active solutions remain on the OSI layer 1, the above mentioned will pose no challenge.

CUBO systems

The HUBER+SUHNER CUBO systems is an active processing platform based on modular line cards that can be inserted and integrated into different indoor or outdoor form factors. In addition to the active line cards, passive modules such as optical multiplexers are also available for the CUBO systems platform. This flexible and unique platform can be used in countless different applications and really has its strong points in the demanding optical access applications such as small cell, macro cell, enterprise access and last mile backhaul.

For example the outdoor enclosures located at the radio sites combined with the 10G and/or 25G transponding multiplexer line cards are ideal for mobile fronthaul transport of current and future 4G/5G RAN.

New line cards with different functionalities are continuously being added to the CUBO systems portfolio.

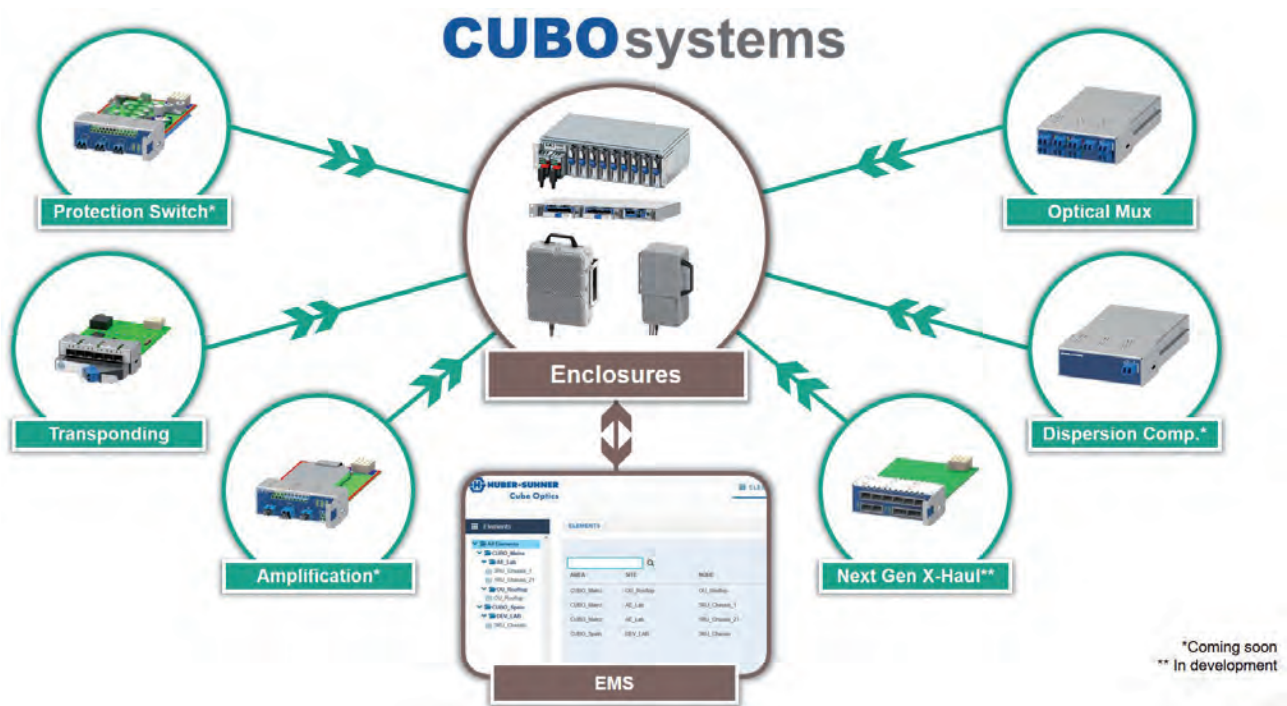

The CUBO advantage

Why the HUBER+SUHNER Cube Optics active transport solution is a good choice:

- **Maximise existing fiber installation →**

Using DWDM the capacity of a pair of fibers can be easily increased to 48 times the capacity and more.

- **Truly vendor agnostic →**

As the active transport solution is based on a layer 1, it is completely transparent for any underlying layers and therefore is transparent for any vendor specific protocols.

- **Fast deployment →**

The active solution is specifically designed to keep installation and configuration time to the bare minimum.

- **5G and 4G hybrid operation →**

Due to WDM, any types of signals can be combined.

- **Future proof →**

The modular concept combined with the flexibility of WDM allows for a simple upgrade with future modules.

- **Designed and made in Europe →**

The active solutions are designed and manufactured in Germany and Spain.

CUBO systems

Small cell application example

The transponding multiplexer can be used in various scenarios. One of them is a hub/spoke setup for small cell applications using a combination of CUBO rack and outdoor units with transponding multiplexer modules.



Macro cell application example

Another scenario for which the transponding multiplexer in conjunction with the terminal multiplexer are an ideal combination is a macro site to CO / edge site setup. Both are placed in the CUBO rack chassis.

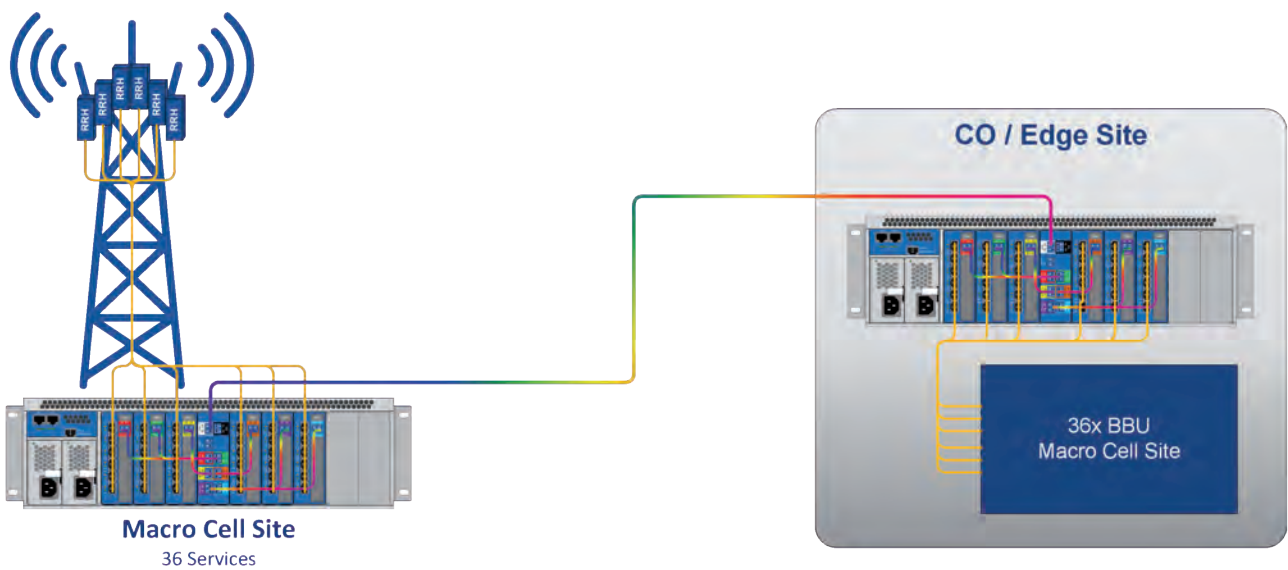



HUBER+SUHNER network cubes



HUBER+SUHNER Cube Optics has specialised on optical wavelength division multiplexing. We offer all types of optical muxes, ranging from simple wideband WDM over coarse WDM to dense WDM. We are able to combine the different WDM grids and/or cascade several muxes in order to create optimal solutions suitable to each customer's needs.

We are very much aware, that each customer has a specific background and therefore a unique network architecture. In order to suite individual needs, we have products that are aimed for point to point or ring deployments (OADMs), that mix and match specific lambdas of different grids or use band splitters in order to allocate more than one wavelengths to certain locations.

Most customers will find products in the following pages covering their needs, but we encourage you to give us the chance to come up with a customised solution for your needs.

Network cube



Features

- Types of modules offered:
 - 1310/1550 wideband Mux and Demux
 - Mux and demux modules, up to 48 channels, cascadable
 - OADM modules, 1, 2 or 4 channels
 - Further modules on demand
- Suitable for CPRI/OBSAI, Ethernet
- Other functions, e.g. integrated taps, band splitter, WWDM, multimode versions etc. on demand
- Your choice of adapter: SC, LC, E2000, MU etc.
- Private labeling and customisation on demand
- For 19" or ETSI racks, adaptable to 23"
- For central office or outside plant as well as line cards for sub-rack mounts
- Also available in WDM splice enclosures or in splice trays of various brands
- Fully RoHS compliant

Ordering information

Description	Insertion loss (dB) ¹⁾		Product family	
CWDM modules (for 1 slot of the WDM modular shell)				
CWDM 4 channel mux and demux for bi-directional data transmission over two fibers. • CWDM channels: 1510, 1530, 1550, 1570 nm	Max.: Typ.:	CWDM < 2.4 1.6	CWDM-MUX-4 C-1643_Rev.A	
CWDM 4 channel mux and demux with EXP band ports for bi-directional data transmission over two fibers. • CWDM channels: 1470, 1490, 1590, 1610 nm • EXP/express band: 1504 to 1578 nm, for later upgrades or "grey" 1550 nm transceivers	Max.: Typ.:	CWDM < 2.5 1.8	Exp < 2.5 1.5	CWDM-MUX-4+EXP C-1705_Rev.A
CWDM 8 channel mux and demux for bi-directional data transmission over two fibers. • CWDM channels: 1470, 1490, 1510, 1530, 1550, 1570, 1590, 1610 nm	Max.: Typ.:	CWDM < 2.8 2.2	CWDM-MUX-8 C-1640_Rev.A	
CWDM 8 channel mux and demux for bi-directional data transmission over two fibers. • CWDM channels: 1270, 1290, 1310, 1330, 1350, 1370, 1390, 1410 nm	Max.: Typ.:	CWDM < 2.8 2.2	CWDM-MUX-8 C-1939_Rev.A	
CWDM 8 channel mux and demux with 1310 band ports for bi-directional data transmission over two fibers. • CWDM channels: 1470, 1490, 1510, 1530, 1550, 1570, 1590, 1610 nm • 1310/WWDM band: 1260 to 1360 nm for "grey" 1310 nm transceivers	Max.: Typ.:	CWDM < 3.6 1.7	WWDM < 1.2 0.7	CWDM-MUX-8+1310 C-1651_Rev.B
CWDM 8 channel mux and demux with UG band ports for bi-directional data transmission over two fibers. • CWDM channels: 1470, 1490, 1510, 1530, 1550, 1570, 1590, 1610 nm • UG/upgrade band: 1260 to 1438 nm, for later upgrades or "grey" 1310 nm transceivers.	Max.: Typ.:	CWDM < 3.6 2.5	UG < 1.2 1.2	CWDM-MUX-8+UG C-1678_Rev.C

¹⁾ Insertion loss over channel bandwidth, valid over full operating temperature range and all states of polarisation with optical connectors.

The typical connector loss is 0.4 dB for a pair of connectors.

Network cube

Ordering information

Description	Insertion loss (dB) ¹⁾		Product family
DWDM modules (fixed 1HU/19" rack-mountable), all these units are also available as 200 GHz units			
DWDM 4 channel (100 GHz grid) mux and demux for bi-directional data transmission over two fibers. <ul style="list-style-type: none"> DWDM channels: to be selected by customer out of the 100 GHz ITU grid 	Max.: Typ.:	DWDM < 2.2 1.3	DWDM-MUX-4 C-1755_Rev.C
DWDM 8 channel (100 GHz grid) mux and demux for bi-directional data transmission over two fibers. <ul style="list-style-type: none"> DWDM channels: to be selected by customer out of the 100 GHz ITU grid 	Max.: Typ.:	DWDM < 3.4 2.2	DWDM-MUX-8 C-2469_Rev.A
DWDM 16 channel (100 GHz grid) mux and demux for bi-directional data transmission over one fiber. <ul style="list-style-type: none"> DWDM channels: to be selected by customer out of the 100 GHz ITU grid. 	Max.: Typ.:	DWDM < 4.0 2.4	DWDM-MUX-8FS C-2513_Rev.B
DWDM 16 channel (100 GHz grid) mux and demux for bi-directional data transmission over two fibers. <ul style="list-style-type: none"> DWDM channels: to be selected by customer out of the 100 GHz ITU grid 	Max.: Typ.:	DWDM < 4.0 2.5	DWDM-MUX-16 C-2402_Rev.A
DWDM 40 channel (100 GHz grid) mux and demux for bi-directional data transmission over two fibers, based on athermal AWG technology with wideband passbands. <ul style="list-style-type: none"> DWDM channels: to be selected by customer out of the 100 GHz ITU grid 	Max.:	DWDM < 3.0	DWDM-MUX-40 C-2819_Rev.A
DWDM 48 channel (100 GHz grid) mux and demux for bi-directional data transmission over two fibers, based on athermal AWG technology with wideband passbands. <ul style="list-style-type: none"> DWDM channels: to be selected by customer out of the 100 GHz ITU grid 	Max.:	DWDM < 3.0	DWDM-MUX-48 C-2848_Rev.A

¹⁾ Insertion loss over channel bandwidth, valid over full operating temperature range and all states of polarisation with optical connectors.

The typical connector loss is 0.4 dB for a pair of connectors.

Network cube

Splice enclosures

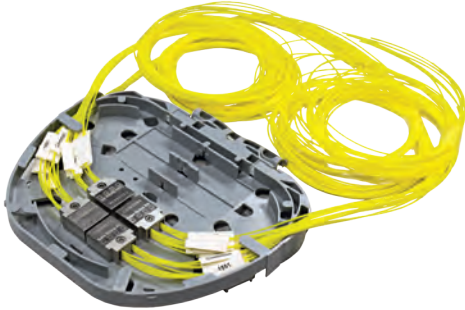

A lot of above shown multiplexing configurations are available in splice enclosures. We provide either the fully assembled enclosure ready for installation on the trays with muxes to be integrated on site in your enclosure. This is available for a wide range of enclosure brands on the market.

Features

- Miniature WDM qualified for damp heat, temperature cycles, shock and vibration in accordance with Telcordia GR1221 uncontrolled environment standard and the GR1209 moisture cycling standard
- Multiplies capacity of point-to-point links within existing hand hole, pole pod or curb-side cabinet nodes
- Splice trays delivered ready for mounting and splicing
- Integrates WDM into a variety of major brands of infrastructure equipment such as 3M and others
- Fully RoHS compliant

Customised form factors



So far shown multiplexing functionality can also be integrated into other form factors to accommodate specific customer needs. Those special requirements can be e.g. outdoor enclosures, higher density or a combination of one of functionalities in one mechanical housing.



HUBER+SUHNER Cube Optics has optimised it's production and supply chain to accommodate such requirements and being able to deliver also small series of WDM products according to special customer requests within a short period of time.

MASTERLINE Ultimate WDM (MLU WDM)



Features

- Connector head with integrated fully passive CWDM or DWDM modules for various outdoor applications
- Facilitate quick network upgrade when it comes to fiber exhaust
- CWDM wavelength ranges in accordance with ITU standard G.694.2
- DWDM wavelength ranges in accordance with ITU standard G.694.1
- Tested in accordance with Telcordia GR-1209/1221
- Available with 6 or 12 Q-ODC sockets with consecutive WDM channels

Specifications

Please find general specification on page 26

Optical specifications CWDM		MLU WDM 12	MLU WDM 6
Operating wavelength range		1260 to 1620 nm	1460 to 1620 nm
Operating channels		C1 – C12	C1 – C6
Optical bandwidth		13 nm	
Insertion loss		< 3.9 dB	
Isolation	adjacent channel	> 30 dB	
	non-adjacent channel	> 40 dB	
Return loss		> 45 dB	
Directivity		> 50 dB	
Polarisation dependent loss		< 0.2 dB	
Max. optical power		< 250 mW	

Optical specifications DWD		MLU WDM 12	MLU WDM 6
Operating channels		C1 – C31	C1 – C25
Channel spacing		100 GHz	
Insertion loss		< 4.3 dB	
Isolation	adjacent channel	> 25 dB	
	non-adjacent channel	> 40 dB	
Return loss		> 45 dB	
Directivity		> 50 dB	
Polarisation dependent loss		< 0.2 dB	
Max. optical power		< 250 mW	

Due to diversity ordering information on request

LOGICAL SETUP

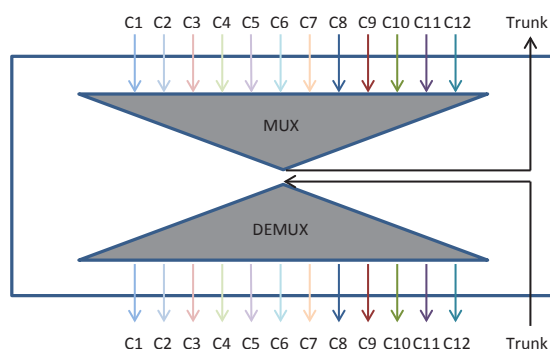



Integrated network cubes



Today, optical multiplexing is a widely spread procedure within fiber optic installations. It's the ideal technology to maximise the fiber capacity as it combines multiple optical signals into a fiber strand.

Normally the form factor of optical multiplexers are based on a 19" chassis system. This is fine for installations within data centers or other indoor locations with vast amounts of rack space available.

However, nowadays the likelihood of having enough rack space is more than slim resulting in the necessity for compact solutions wherever possible, including the multiplexer solutions. In addition optical multiplexing is also required in other installations without 19" chassis mounting as well as for applications in outdoor environments.

The integrated network cubes are specifically designed for these challenges and combine innovative fiber management systems, wall box systems and outdoor enclosures with state of the art WDM technology.

The enclosures used for the integrated network cubes are among others the highly acclaimed HUBER+SUHNER fiber management systems IANOS and LISA, the wall boxes Optibox and the MASTERLINE Ultimate products. The WDM technology is based on the state of the art HUBER+SUHNER Cube Optics network cubes.

Integrated network cubes

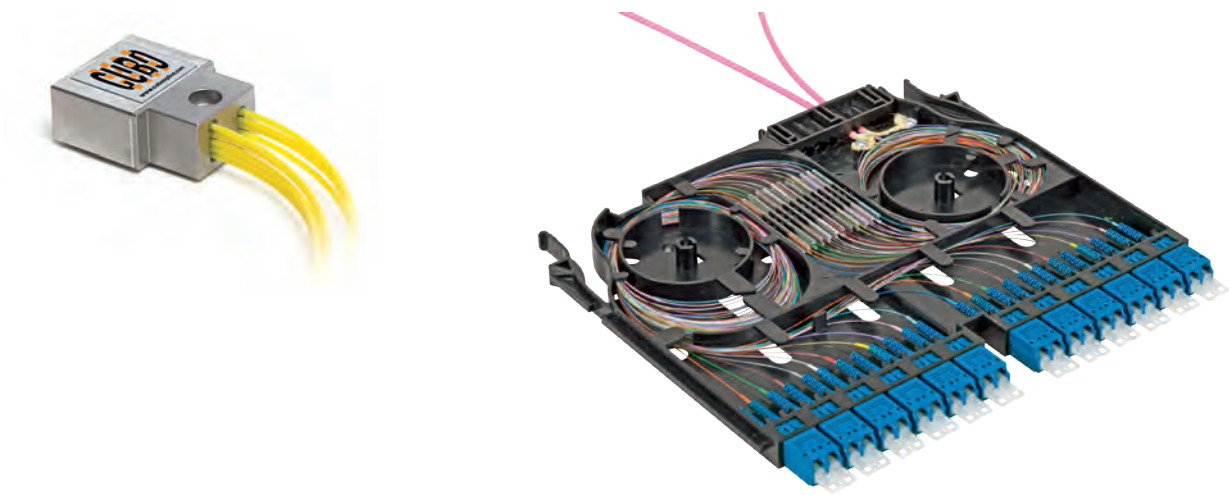

Integrated network cubes: A combination of state of the art multiplexer and innovative enclosures

WDM grid options

Optical multiplexing has been standardised in two grids, CWDM and DWDM

CWDM	18 Channels																	
Wavelength	1271	1291	1311	1331	1351	1371	1391	1411	1431	1451	1471	1491	1511	1531	1551	1571	1591	1611
DWDM														100+ Channels				

CWDM

Coarse Wavelength Division Multiplex (18 channels)

DWDM

Dense Wavelength Division Multiplex (100+ channels)

Upgrade port

Most multiplexers don't cover all available channels. The upgrade port allows the addition of any of the missing channels both for CWDM and DWDM multiplexer.

1310 port

The 1310 port enables the addition of a wideband „gray“ wavelength and can be combined with any DWDM multiplexers or CWDM multiplexers using the top half of the grid channels.

Integrated network cubes

WDM types

Type	Schematic	Description
Mux		Dual Fiber Optical Multiplexer Uses two separate fiber connections for transmission (TX) and reception (RX). The number of wavelengths therefore is identical to the number of TX/RX channels.
Mux +UG		Dual Fiber Optical Multiplexer + Upgrade Uses two separate fiber connections for transmission (TX) and reception (RX). These multiplexers have a dual fiber upgrade port, which allows the addition of fiber channels that are not already covered by the multiplexer.
Mux SF		Single Fiber Optical Multiplexer Requires a single fiber for both transmission (TX) and reception (RX). The number of required wavelengths therefore is double the number of TX/RX channels.
Mux SF +UG		Single Fiber Optical Multiplexer + Upgrade Requires a single fiber for both transmission (TX) and reception (RX). These multiplexers have a single fiber upgrade port, which allows the addition of fiber channels that are not already covered by the multiplexer.
OADM		Dual Fiber Optical Add Drop Multiplexer East and West connection each uses a separate fiber for transmission (TX) and reception (RX). The number of add/drop channels is identical to the number of wavelengths.
OADM SF		Single Fiber Optical Add Drop Multiplexer East and West connection each only require a single fiber for TX and RX. The number of add/drop channels therefore is double the number of wavelengths.

IANOS® – Fiber management system

The IANOS® system from HUBER+SUHNER is a state-of-the-art fiber optic management system which facilitates fast, flexible and future-proof connectivity in the data center. It is made up of IANOS chassis (multiple versions and sizes available) and IANOS modules.



Data centers are constantly adapting to reflect the demands placed on them, and today's fiber management systems need to accommodate these changes with the minimum amount of cost, time and disruption.

As data centers evolve, we see a broad mixture of applications depending on the location, the business model and of course the data demand. IANOS accommodates these changes by offering the widest range of connectivity scenarios in a single generic platform.

Many of these data center applications require optical multiplexing. Instead of having separate multiplexing units, the IANOS modules with integrated HUBER+SUHNER Cube Optics network cubes are an ideal and space saving solution.

The IANOS modules come in two sizes, a single and a double width module. The single width module accommodates 6 LC duplex connectors whereas the double width module accommodates 12 LC duplex connectors. Depending on the type of network cube and number of channels either the single or double module is used.



Enclosure specification		
Type	Single module (S)	Double module (D)
Connectors	6 × LC duplex	12 × duplex
Dimensions (W×H×D)	97 × 12 × 172 mm 3.81 × 0.47 × 6.77 in	196 × 12 × 172 mm 7.71 × 0.46 × 6.77 in
Image		
Chassis	Compatible with IANOS® EDR 1U/4U and EDR zero space chassis	

IANOS® – Fiber management system











Compatibility matrix

The integrated network cube concept is extremely flexible allowing a wide range of combinations in different enclosures. However, there are limitations due to space within the enclosure and number of available fiber connections. At the same time it for example doesn't make sense to have a Network Cube with only a small number of channels in a large enclosure. The following compatibility matrix gives an overview of what WDM type and grid combination is available for the IANOS® system.

		Mux-2	Mux-2 +UG	Mux-3	Mux-3 +UG	Mux-4	Mux-4 +UG	Mux-8	Mux-8 +UG	Mux-8 +1310	Mux-16	Mux-8 2F (Dual)	Mux-1 SF	Mux-2 SF	Mux-2 SF +UG	Mux-3 SF	Mux-3 SF +UG	Mux-4 SF	Mux-4 SF +UG	Mux-6 SF	Mux-8 SF	OADM-1	OADM-2	OADM-3	OADM-4	OADM-1 SF	OADM-2 SF	OADM-3 SF	OADM-4 SF
Single	CWDM	✓	✓	✓	✓	✓	✓	✗	✗	✗	✗	✗	✓	✓	✓	✓	✓	✓	✓	✗	✗	✓	✓	✓	✓	✓	✓	✗	✗
	DWDM	✓	✓	✓	✓	✓	✓	✗	✗	✗	✗	✗	✓	✓	✓	✓	✓	✓	✓	✗	✗	✓	✓	✓	✓	✓	✓	✗	✗
Double	CWDM	✗	✗	✗	✗	✗	✗	✓	✓	✓	✓	✓	✗	✗	✗	✗	✗	✗	✗	✗	✗	✗	✗	✗	✗	✗	✗	✓	✓
	DWDM	✗	✗	✗	✗	✗	✗	✓	✓	✓	✓	✓	✗	✗	✗	✗	✗	✗	✗	✓	✓	✗	✗	✗	✗	✗	✗	✓	✓

IANOS® – integrated network cube versions (selection)

In addition to the WDM type, grid and enclosure combination, the integrated network cube are available with virtually any wavelength combination within the respective grid. The following table merely is a selection of available modules. If you require a version that isn't listed or more technical details regarding the optical performance, please contact HUBER+SUHNER Cube Optics.

Grid	Type	Size	Description	Item no.
CWDM		D	Mux-8: 1471, 1491, 1511, 1531, 1551, 1571, 1591, 1611 nm channel insertion loss (dB): < 3.3	85111853
		S	Mux-2+UG: 1511, 1571nm/UG: all remaining CWDM channels channel insertion loss (dB): < 1.6/upgrade insertion loss (dB): < 1.4	85111854
		S	Mux-4 SF: 1471, 1491, 1511, 1531, 1551, 1571, 1591, 1611 nm channel insertion loss (dB): < 3.3	85111855
		S	OADM-2: 1311, 1531 nm (add = drop channels) In to drop/add to out insertion loss (dB): < 1.8/in to out (dB): < 2	85111856
		D	OADM-3 SF: 1451, 1471, 1491, 1511, 1591, 1611 nm In to drop/add to out insertion loss (dB): < 2.8/in to out (dB): < 1.2	85111857
	DWDM		D	Mux-8+1310: channel 18, 19, 20, 21, 22, 23, 24, 25 channel insertion loss (dB): < 3.1/1310 insertion loss (dB): < 1.4
		D	Mux-16: channel 18, 19, 20, 21, 22, 23, 24, 25, 27, 28, 29, 30, 31, 32, 33, 34 channel insertion loss (dB): < 3.5	85111859
		D	Mux-6 SF: channel 27, 28, 29, 30, 31, 32, 33, 34, 36, 37, 38, 39 channel insertion loss (dB): < 3.9	85111860
		S	Mux-1 SF: channel 21, 24 channel insertion loss (dB): < 1.4	85111861
		D	OADM-4: channel 21, 22, 23, 24 (add = drop channels) In to drop/add to out insertion loss (dB): < 2.3/in to out (dB): < 2.9	85111862
		S	OADM-1 SF: channel 21, 24 In to drop/add to out insertion loss (dB): < 1.8/in to out (dB): < 1.2	85111863

 Dual fiber Mux	 Single fiber Mux	 Dual fiber OADM	 Single fiber OADM
--	--	---	---

LISA – fiber management system

LISA is a dedicated high-density fiber management system commonly used as a centralised cross-connect in the main distribution area (MDA) of large data centers. With a 300 mm depth and full access from the front side, LISA cabinets can be positioned against unused walls, at the end of cold aisles or back-to-back on a single floor tile.

LISA racks have a density of 1500 LC ports per rack or 3000 LC ports per tile when placed back-to-back.

The main difference between LISA and conventional 19" panels is the fact that LISA is fully accessible from the front side.

LISA fiber trays are the side-facing connectivity blocks that are inserted into tray units within high-density CDR racks. Designed for speed of installation and improved accessibility, the LISA fiber trays can be installed and removed in under 10 seconds. Fiber trays are available to cover a wide range of applications. With integrated HUBER+SUHNER Cube Optics network cubes, optical multiplexing applications are available in this very compact and easily accessible system.

The LISA modules are available with 12 or 18 LC duplex connectors. Depending on the type of Network Cube and number of channels either the 12 or 18 LC duplex connector version is used.



Enclosure specification	
Connectors	12 or 18x LC duplex
Dimensions (W×H×D)	288 × 18 × 262 mm (with hinge and patch cord arm) 11.38 × 0.71 × 10.32 in
Rack unit height	0.5U
Image	
Chassis	Compatible with all LISA rack solutions

LISA – fiber management system













Compatibility matrix

The integrated network cube concept is extremely flexible allowing a wide range of combinations in different enclosures. However, there are limitations due to space within the enclosure and number of available fiber connections. At the same time it for example doesn't make sense to have a network cube with only a small number of channels in a large enclosure. The following compatibility matrix gives an overview of what WDM type and grid combination is available for the LISA system.

	Mux-2	Mux-2 +UG	Mux-3	Mux-3 +UG	Mux-4	Mux-4 +UG	Mux-8	Mux-8 +UG	Mux-8 +1310	Mux-16	Mux-8 2F (Dual)	Mux-1 SF	Mux-2 SF	Mux-2 SF +UG	Mux-3 SF	Mux-3 SF +UG	Mux-4 SF	Mux-4 SF + UG	Mux-6 SF	Mux-8 SF	OADM-1	OADM-2	OADM-3	OADM-4	OADM-1 SF	OADM-2 SF	OADM-3 SF	OADM-4 SF
CWDM	✓	✓	✓	✓	✓	✓	✓	✓	✓	✗	✓	✓	✓	✓	✓	✓	✓	✓	✗	✗	✓	✓	✓	✓	✓	✓	✓	✓
DWDM	✗	✗	✗	✗	✗	✗	✗	✗	✗	✗	✗	✗	✗	✗	✗	✗	✗	✗	✗	✗	✗	✗	✗	✗	✗	✗	✗	✗

LISA – integrated network cube versions (selection)

In addition to the WDM type, grid and enclosure combination, the integrated network cubes are available with virtually any wavelength combination within the respective grid. The following table merely is a selection of available modules. If you require a version that isn't listed or more technical details regarding the optical performance, please contact H+S Cube Optics.

Grid	Type	Description	Item no.
CWDM		Mux-3: 1511, 1531, 1551 nm channel insertion loss (dB): < 2.1	85111865
		Mux-3+UG: 1511, 1531, 1551 nm /UG: all remaining CWDM channels channel insertion loss (dB): < 2.4/upgrade insertion loss (dB): < 1.4	85111866
		Mux-8: 1471, 1491, 1511, 1531, 1551, 1571, 1591, 1611 nm channel insertion loss (dB): < 3.3	85111867
		Mux-8 2F (dual module): 1471, 1491, 1511, 1531, 1551, 1571, 1591, 1611 nm channel insertion loss (dB): < 3.3	85111869
		Mux-2 SF: 1511, 1531, 1551, 1571 nm channel insertion loss (dB): < 2.4	85111870
		Mux-2 SF+UG: 1551, 1571, 1591, 1611 nm/UG: all remaining CWDM channels channel insertion loss (dB): < 2.4/upgrad insertion loss (dB): < 1.7	85111871
		Mux-4 SF+UG: 1471, 1491, 1511, 1531, 1551, 1571, 1591, 1611 nm channel insertion loss (dB): < 3.6/upgrade insertion loss (dB): < 1.4	85111872
		OADM-1: 1451 nm (add = drop channels) In to drop/add to out insertion loss (dB): < 1.4/in to out (dB): < 1.2	85111873
		OADM-4: 1311, 1531, 1551, 1571 nm (add = drop) In to drop/add to out insertion loss (dB): < 2.4/in to out (dB): < 2.9	85111874
		OADM-1 SF: 1271, 1311 nm In to drop/add to out insertion loss (dB): < 1.8/in to out (dB): < 1.2	85111876
		OADM-3 SF: 1451, 1471, 1491, 1511, 1591, 1611 nm In to drop/add to out insertion loss (dB): < 2.8/in to out (dB): < 1.2	85111878
		OADM-4 SF: 1471, 1491, 1511, 1531, 1551, 1571, 1591, 1611 nm In to drop/add to out insertion loss (dB): < 3.3/in to out (dB): < 1.2	85111879

	Dual fiber Mux		Single fiber Mux		Dual fiber OADM		Single fiber OADM
---	----------------	---	------------------	---	-----------------	---	-------------------

Optibox – wall enclosures

The Optibox family of products from HUBER+SUHNER are a range of wall enclosures act as the interface between the optical access network of the service provider (drop cable) and the internal „In-the-Home“ network. A passive connection enclosure at the Building Entry Point (BEP) is used for splicing, routing or connecting fibers.

The Optibox products offer a comprehensive enclosure portfolio to address a large variety of applications. From large buildings such as multi-dwelling units (MDU) to single family homes, with patching, splicing and splitting capabilities, the Optibox family satisfies the most demanding applications.





Combined with the integrated HUBER+SUHNER Cube Optics network cubes, the Optibox product range is the ideal solution for a wide range of additional applications.

Depending on the type of network cube and number of channels the best suited Optibox is used.

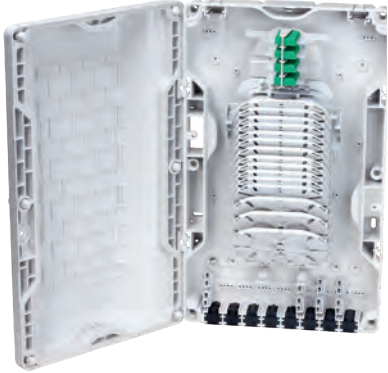

Enclosure specification		
Optibox 4		
Connectors	4x LC duplex	
Dimensions (WxHxD)	150 x 250 x 46 mm 5.9 x 9.84 x 1.81 in	
Ingress protection	IP54	
Optibox 4i		
Connectors	4x LC duplex	
Dimensions (WxHxD)	150 x 250 x 46 mm 5.9 x 9.84 x 1.81 in	
Ingress protection	IP67	

Optibox – wall enclosures

Enclosure specification		
Optibox 6		
Connectors	6× LC duplex	
Dimensions (WxHxD)	154 × 250 × 46 mm 6.06 × 9.84 × 1.81 in	
Ingress protection	IP54	
Optibox S8		
Connectors	8× LC duplex	
Dimensions (WxHxD)	210 × 260 × 75 mm 8.27 × 10.24 × 2.95 in	
Ingress protection	IP65	
Optibox 12		
Connectors	12× LC duplex	
Dimensions (WxHxD)	260 × 425 × 92 mm 10.23 × 16.73 × 3.62 in	
Ingress protection	IP56	
Optibox 16		
Connectors	16× LC duplex	
Dimensions (WxHxD)	347 × 437 × 109 mm 13.67 × 17.2 × 4.3 in	
Ingress protection	IP56	

Optibox – wall enclosures

Compatibility matrix

The integrated network cube concept is extremely flexible allowing a wide range of combinations in different enclosures. However, there are limitations due to space within the enclosure and number of available fiber connections. At the same time it for example doesn't make sense to have a network cube with only a small number of channels in a large enclosure.



The following compatibility matrix gives an overview of what WDM type and grid combination is available for the Optibox enclosures.

	Mux-2	Mux-2 +UG	Mux-3	Mux-3 +UG	Mux-4	Mux-4 +UG	Mux-8	Mux-8 +UG	Mux-8 +1310	Mux-16	Mux-8 2F (Dual)	Mux-1 SF	Mux-2 SF	Mux-2 SF +UG	Mux-3 SF	Mux-3 SF +UG	Mux-4 SF	Mux-4 SF + UG	Mux-6 SF	Mux-8 SF	OADM-1	OADM-2	OADM-3	OADM-4	OADM-1 SF	OADM-2 SF	OADM-3 SF	OADM-4 SF	
Optibox 4																													
CWDM	✓	✓	✓	✗	✓	✗	✗	✗	✗	✗	✗	✓	✓	✓	✓	✓	✓	✓	✗	✗	✓	✓	✗	✗	✓	✓	✗	✗	✗
DWDM	✓	✓	✓	✗	✓	✗	✗	✗	✗	✗	✗	✓	✓	✓	✓	✓	✓	✓	✗	✗	✓	✓	✗	✗	✓	✓	✗	✗	✗
Optibox 4i																													
CWDM	✓	✓	✓	✗	✓	✗	✗	✗	✗	✗	✗	✓	✓	✓	✓	✓	✓	✓	✗	✗	✓	✓	✗	✗	✓	✓	✗	✗	✗
DWDM	✓	✓	✓	✗	✓	✗	✗	✗	✗	✗	✗	✓	✓	✓	✓	✓	✓	✓	✗	✗	✓	✓	✗	✗	✓	✓	✗	✗	✗
Optibox 6																													
CWDM	✗	✗	✗	✓	✗	✓	✗	✗	✗	✗	✗	✗	✗	✗	✗	✗	✗	✗	✗	✗	✗	✗	✗	✓	✓	✗	✗	✗	✗
DWDM	✗	✗	✗	✗	✗	✗	✗	✗	✗	✗	✗	✗	✗	✗	✗	✗	✓	✗	✗	✗	✗	✗	✗	✓	✓	✗	✗	✗	✗
Optibox S8																													
CWDM	✗	✗	✗	✗	✗	✗	✗	✗	✗	✗	✗	✓	✓	✓	✓	✓	✓	✓	✗	✗	✗	✗	✗	✗	✓	✓	✗	✗	✗
DWDM	✗	✗	✗	✗	✗	✗	✗	✗	✗	✗	✗	✓	✓	✓	✓	✗	✗	✗	✗	✗	✗	✗	✗	✗	✗	✗	✗	✗	✗
Optibox 12																													
CWDM	✗	✗	✗	✗	✗	✗	✓	✗	✗	✗	✗	✗	✗	✗	✗	✗	✗	✗	✗	✗	✗	✗	✗	✗	✗	✗	✗	✗	✗
DWDM	✗	✗	✗	✗	✗	✗	✓	✗	✗	✗	✗	✗	✗	✗	✗	✗	✗	✗	✗	✗	✓	✓	✗	✗	✗	✗	✗	✗	✗
Optibox 16																													
CWDM	✗	✗	✗	✗	✗	✗	✗	✗	✗	✗	✗	✗	✗	✗	✗	✗	✗	✗	✗	✗	✗	✗	✗	✗	✗	✗	✗	✗	✗
DWDM	✗	✗	✗	✗	✗	✗	✗	✗	✗	✓	✗	✗	✗	✗	✗	✗	✗	✗	✗	✗	✓	✓	✗	✗	✗	✗	✗	✗	✗

Optibox – wall enclosures

Optibox – integrated network cube versions (selection)

In addition to the WDM type, grid and enclosure combination, the integrated network cubes are available with virtually any wavelength combination within the respective grid. The following table merely is a selection of available modules. If you require a version that isn't listed or more technical details regarding the optical performance, please contact HUBER+SUHNER Cube Optics.

Box	Grid	Type	Description	Item no.
Optibox 4	CWDM		Mux-3: 1511, 1531, 1551 nm channel insertion loss (dB): < 2.1	85111881
			Mux-3 SF: 1471, 1491,1511, 1531, 1551, 1571 nm channel insertion loss (dB): < 2.6	85111882
	DWDM		Mux-4: channel 21, 22, 23, 24 channel insertion loss (dB): < 2.4	85111883
			OADM-2 SF: C27, C28, C45, C46 In to drop/add to out insertion loss (dB): <1.8/in to out (dB): < 2	85111884
Optibox 4i	CWDM		Mux-3 SF+UG: 1471, 1491,1511, 1531, 1551, 1571 nm channel insertion loss (dB): < 3/upgrade insertion loss (dB): < 1.2	85111886
			OADM-1: 1451 nm (add = drop channels) In to drop/add to out insertion loss (dB): < 1.4/in to out (dB): < 1.2	85111888
	DWDM		Mux-4 SF: channel 27, 28, 29, 30, 31, 32, 33, 34 channel insertion loss (dB): < 3.3	85111890
			OADM-1 SF: channel 21, 24 In to drop/add to out insertion loss (dB): < 1.8/in to out (dB): < 1.2	85111892
Optibox 6	CWDM		Mux-3+UG: 1511, 1531, 1551 nm/UG: all remaining CWDM channels channel insertion loss (dB): < 2.4/upgrade insertion loss (dB): < 1.4	85111894
			Mux-4+UG: 1511, 1531, 1551, 1571 nm /UG: all remaining CWDM channels channel insertion loss (dB): < 2.7/upgrade insertion loss (dB): < 1.4	85111895
			OADM-4: 1311, 1531, 1551, 1571nm (add = drop channels) In to drop/add to out insertion loss (dB): < 2.4/in to out (dB): < 2.9	85111897
Optibox 8	CWDM		Mux-2 SF+UG: 1551, 1571, 1591, 1611 nm/UG: all remaining CWDM channels channel insertion loss (dB): < 2.4/upgrade insertion loss (dB): < 2.7	85111899
			Mux-3 SF+UG: 1471, 1491,1511, 1531, 1551, 1571 nm channel insertion loss (dB): < 3/upgrade insertion loss (dB): < 1.4	85111900
			OADM-2 SF: 1271, 1291, 1311, 1331 nm In to drop/add to out insertion loss (dB): < 2.4/in to out (dB): < 1.2	85111902
			OADM-4 SF: 1471, 1491, 1511, 1531, 1551, 1571, 1591, 1611nm In to drop/add to out insertion loss (dB): < 3.3/in to out (dB): < 1.2	85111903
Optibox 12	DWDM		Mux-8 SF: channel 27, 28, 29, 30, 31, 32, 33, 34, 36, 37, 38, 39, 40, 41, 42, 43 channel insertion loss (dB): < 3.3	85111905
			Mux-6 SF: channel 27, 28, 29, 30, 31, 32, 33, 34, 36, 37, 38, 39 channel insertion loss (dB): < 3.9	85111907
			Mux-8 SF: channel 27, 28, 29, 30, 31, 32, 33, 34, 36, 37, 38, 39, 40, 41, 42, 43 channel insertion loss (dB): < 4.0	85111908
Optibox 16	DWDM		Mux-16: channel 18, 19, 20, 21, 22, 23, 24, 25, 27, 28, 29, 30, 31, 32, 33, 34 channel insertion loss (dB): < 3.5	85111910
			Mux-6 SF: channel 27, 28, 29, 30, 31, 32, 33, 34, 36, 37, 38, 39 channel insertion loss (dB): < 3.9	85111911
			Mux-8 SF: channel 27, 28, 29, 30, 31, 32, 33, 34, 36, 37, 38, 39, 40, 41, 42, 43 channel insertion loss (dB): < 4.0	85111912



Dual fiber Mux



Single fiber Mux



Dual fiber OADM



Single fiber OADM

MASTERLINE Classic – FTFA box

The MASTERLINE Classic FTFA Boxes are mainly designed for remote radio installations. These ruggedised outdoor Fiber-To-The-Antenna (FTFA) boxes are a cost effective method for an effective and flexible installation for mobile networks. Usually, a multifiber riser cable is connected to the mast mounted FTFA distribution box which is then linked to the remote radio heads with short jumper cables.

For the integrated network cubes the MASTERLINE Classic FTFA box medium is the perfect choice. The compact size, together with the IP67 ingress protection makes this integrated network cube ideal for a wide range of indoor and outdoor applications.

Especially for centralised radio access networks using passive fronthaul to the cell sites, the integrated network cube based on the MASTERLINE Classic FTFA box medium is a good choice, as it combines all features required by this application.



Enclosure specification	
Connectors	18x LC duplex
Dimensions (WxHxD)	240 x 240 x 132 mm 9.45 x 9.45 x 5.2 in
Material	glass-filled polycarbonate, halogen-free, UV resistant
Flammability rating	UL 94 V0
Ingress protection	IP67
Impact resistance	IK 07 (EN 62262)

MASTERLINE Classic – FTTA box













Compatibility matrix

In addition to the WDM type, grid and enclosure combination, the integrated network cubes are available with virtually any wavelength combination within the respective grid. The following table merely is a selection of available modules. If you require a version that isn't listed or more technical details regarding the optical performance, please contact HUBER+SUHNER Cube Optics.

	Mux-2	Mux-2 +UG	Mux-3	Mux-3 +UG	Mux-4	Mux-4 +UG	Mux-8	Mux-8 +UG	Mux-8 +1310	Mux-16	Mux-8 2F (Dual)	Mux-1 SF	Mux-2 SF	Mux-2 SF +UG	Mux-3 SF	Mux-3 SF +UG	Mux-4 SF	Mux-4 SF +UG	Mux-6 SF	Mux-8 SF	OADM-1	OADM-2	OADM-3	OADM-4	OADM-1 SF	OADM-2 SF	OADM-3 SF	OADM-4 SF	
CWDM	x	x	x	x	x	x	x	x	✓	x	x	x	x	x	x	x	x	x	x	x	x	x	x	x	x	x	x	✓	✓
DWDM	✓	✓	✓	✓	✓	✓	✓	x	x	x	x	✓	✓	✓	✓	✓	✓	✓	✓	✓	x	x	x	x	x	✓	✓	✓	

MLC FTTA – integrated network cubes versions (selection)

In addition to the WDM type, grid and enclosure combination, the integrated network cubes are available with virtually any wavelength combination within the respective grid. The following table merely is a selection of available modules. If you require a version that isn't listed or more technical details regarding the optical performance, please contact HUBER+SUHNER Cube Optics.

Grid	Type	Description	Item no.
DWDM		Mux-2: channel 21, 23 channel insertion loss (dB): < 1.2	85111913
		Mux-4: channel 21, 22, 23, 24 channel insertion loss (dB): < 2.4	85111914
		Mux-8: channel 18, 19, 20, 21, 22, 23, 24, 25 channel insertion loss (dB): < 3.3	85111915
		Mux-2 SF: channel 21, 22, 23, 24 channel insertion loss (dB): < 2.4	85111916
		Mux-3 SF: channel 27, 28, 29, 30, 31, 32 channel insertion loss (dB): < 2.6	85111917
		Mux-4 SF: channel 27, 28, 29, 30, 31, 32, 33, 34 channel insertion loss (dB): < 3.3	85111918
		Mux-8 SF: channel 27, 28, 29, 30, 31, 32, 33, 34, 36, 37, 38, 39, 40, 41, 42, 43 channel insertion loss (dB): < 4.0	85111919
		OADM-3: C21, C22, C23 (add = drop channels) In to drop/add to out insertion loss (dB): < 2.1/in to out (dB): < 2.3	85111920
		OADM-1: C21 (add = drop) In to drop/add to out insertion loss (dB): < 1.4/in to out (dB): < 1.2	85111921
		OADM-4 SF: C18, C19, C20, C21, C22, C23, C24, C25 In to drop/add to out insertion loss (dB): < 3.3/in to out (dB): < 1.2	85111922
		OADM-3 SF: C27, C28, C29, C45, C46, C47 In to drop/add to out insertion loss (dB): < 3/in to out (dB): < 1.2	85111923
		OADM-2 SF: C27, C28, C45, C46 In to drop/add to out insertion loss (dB): < 2.4/in to out (dB): < 1.2	85111924



Dual fiber Mux



Single fiber Mux



Dual fiber OADM



Single fiber OADM



HUBER+SUHNER pluggable transceiver

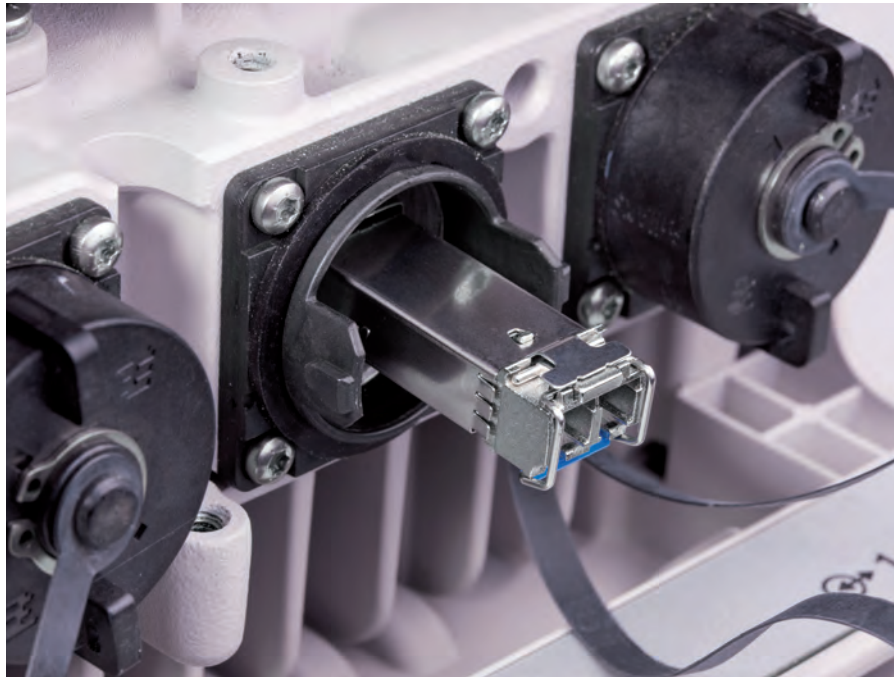

HUBER+SUHNER provides a full range of pluggable optical transceivers, approx. 2000 different types available, all compatible to MSA standard.

We are covering all major protocols and data rates (most importantly Ethernet and CPRI/OBSAI up to 100 Gbps). Our transceivers are available grey (850 nm MM/1310 nm SM/1550 nm SM) or coloured CWDM and DWDM, supporting MMF or SMF fiber at multiple power budgets to cover different distances.

The CUBO transceivers are compatible with all common active equipment, such as BBU/RRH and other small cell equipment.

Transceiver

2 core power supply cable PVC jacket material, UL listed (TC-ER)



Features

- Compliant with SFP/SFP+/QSFP(28) MSA
- Data rate up to 100 Gbps
- Transmission distance up to 160 km
- Low power consumption
- Extreme reliability
- All major codings available without surcharge
- RoHS 6/6 compliant
- Laser class 1 IEC-60825 compliant
- Case operation temperature range:
 - Commercial: 0 to 70 °C
 - Industrial: -40 to 85 °C
- Applications: Ethernet, CPRI/OBSAI, eCPRI

Typical transceiver used for wireless application

All industrial temperature (-40 to +85 °C operating), uncoded and including DMI

Form factor	Media	Protocol	Data rate	Distance
SFP	CWDM (1270 to 1610 nm)	Ethernet, CPRI 2	up to 1.25G	40 km
SFP	CWDM (1470 to 1610 nm)	Ethernet, CPRI 2	up to 1.25G	80 km
SFP	DWDM (ch17 – ch61)	Ethernet, CPRI 2 – 3	1.25G and 2.5G	80 km and 120 km
SFP	1310 nm (LX)	Ethernet, CPRI 2	up to 1.25G	2+ km ... 40 km
SFP	Bidi (various wavelength)	Ethernet, CPRI 2	up to 1.25G	20 km ... 160 km
SFP	850 nm (SX) MM fiber	Ethernet, CPRI 2	up to 1.25G	0.5 km
SFP+	1310 nm (LR)	Ethernet, CPRI 2 - 6	up to 6.1G	10 km
SFP+	850 nm (SR) MM fiber	Ethernet, CPRI 2 – 8	up to 10.1G	0.3 km
SFP+	1310 nm (LR)	Ethernet, CPRI 2 – 8	up to 10.1G	2+ km ... 40 km
SFP+	Bidi, 1270/1330 nm	Ethernet, CPRI 2 – 8	up to 10.1G	10 km ... 80 km
SFP+	CWDM (1270 to 1610 nm)	Ethernet, CPRI 2 – 8	up to 10.1G	10 km
SFP+	CWDM (1470 to 1610 nm)	Ethernet, CPRI 2 – 8	up to 10.1G	40 km and 80 km
SFP+	DWDM (ch17 – ch61)	Ethernet, CPRI 2 – 8	up to 10.1G	40 km and 80 km
SFP28	1310 nm (LR)	Ethernet, CPRI 10	up to 25G	10 km
SFP28	Bidi 1270/1310 nm	Ethernet, CPRI 10	up to 25G	10 km ... 30 km
SFP28	DWDM c-Band	Ethernet, CPRI 10	up to 25G	10 km ...15 km
QSFP28	1310 nm (LR4)	Ethernet	up to 112G	10 km
QSFP28	1310 nm (eLR4)	Ethernet	up to 103G	25 km

Transceiver selection guide

Selecting the right transceiver can be a challenge due to the wide range of available products. For HUBER+SUHNER to be able to propose the one transceiver to match the application and hardware, all below stated parameters A-E have to be determined and specified. Only with a complete set of parameters can we propose a suitable transceiver for a specific enquiry.

A Transceiver type "form factor"/MSA type

The transceiver has to mechanically and electrically fit into a given active equipment.
Transceiver MSAs define mechanical form factors including electric interface as well as power consumption and cable connector types.
SFP/SFP+

B Protocol and data rate

Different switch/router support different protocols and data rates.
CPRI: Rate 1 (0.6 G/s), Rate 2 (1.2 G/s), Rate 3 (2.5 G/s), Rate 4 (3.0 G/s), Rate 5 (4.9 G/s), Rate 6 (6.1 G/s), Rate 7 (9.8 G/s)
Ethernet: Gigabit Ethernet, 10 GE

C Power budget

The transceiver power budget is the difference between laser launch power and receiver sensitivity and has to be 2 to 3 dB larger than the measured link loss. If the link loss cannot be measured it has to be calculated by adding up individual losses: transmission distance (km) + fiber type (or OTDR trace), number of ODFs, patches, splices, passive optical components (e.g. splitter and muxes) and other sources of loss have to be known. Please state all individual losses.
Power budget (dB)
common values are < 10, 14, 20, 24, 28, > 30

D Transport media/transceiver "colour"

What transport media will be used: copper, single mode fiber (SMF), multimode fiber (MMF).
If SMF is used what is the optical transmission spectrum: "grey" (wide 1310/wide 1550 nm) or "coloured" (CWDM or DWDM).
If CWDM or DWDM shall be used, channels need to be specified.
850 nm MM/1310 nm grey/1550 nm grey/CWDM (1270 to 1610 nm)/DWDM (100 GHz ch 17 to 61)/
Bi-Di (please specify wave-length pair)
MM = Multimode/all others are single mode.

E Equipment compatibility/"coding"

In what switch/router is the transceiver supposed to work. Is the equipment "open for 3rd party transceivers" or "vendor locked".
Often switch/router is vendor locked, so, the transceiver has to be coded to be accepted by the equipment.
Therefore switch/router brand and model must be known (e.g. Cisco Catalyst 8500)
In case switch/router open for 3rd party transceivers, chose uncoded/none
3 Com/Alcatel/Arista/Brocade (pls. differ from Foundry)/Ciena/Cisco/Dell/Ericsson/Extreme/Force10/Juniper/HP/Huawei/Marconi/Nortel/Transmode



Timing solutions – GPS over Fiber

As capacity increases, very low latency as well as precision timing and synchronization are needed to ensure closer coordination between cell sites. Limited power infrastructures, coupled with the complexity and time required to install multiple antennas on structural rooftops, are challenging the network expansion. Working with the leading telecommunications company in North America, HUBER+SUHNER developed a game-changing Direct GPS-over-Fiber solution for telecommunication and data center customers in search of scalable timing infrastructure solutions for outdoor remote antenna applications that provide efficient installation, flexible configurations and no need for power infrastructure at the remote end.

The Direct GPS-over-Fiber portfolio offers fast and easy-to-install solutions for timing infrastructure that are compact with integrated transmitters which reduce hardware costs by taking away the need for multiple GPS antennas, can reach longer distances over fiber optic cabling (GPS-over-Fiber) and eliminates the need for costly remote antenna power infrastructure with a copper-free GPS link that uses fiber optic cabling (Power-over-Fiber) to distribute both power and signal.



Structure

The compact space-saving design of Direct GPS-over-Fiber dramatically reduces the amount of hardware and equipment needed



Enhance

The ease-of-use benefits of Direct GPS-over-Fiber help free up time for resources to be spent elsewhere.



Drive

Direct GPS-over-Fiber optimizes ownership and lifecycle costs leaving more capital and

Portfolio overview

GPS-over-Fiber portfolio

GPS-over-Fiber Transmitter (TX) Modules (E/O Conversion)

Item-No	Product Description	# of RF Inputs	# FO outputs	Form factor
85065409	GPSof1 - 1.5GHz (TX)	1 SMA	1 FC/APC	Din Rail mount
85072905	GPSof1 - 1.5GHz (TX) L1+L2	1 SMA	1 FC/APC	Din Rail mount
85135572	GPSof1 (TX) [LC/PC]	1 SMA	1 LC/UPC	Din Rail mount
85145805	GPSof1 (TX) [LC/PC] IP66 AC	1 SMA	1 LC/UPC	Outdoor enclosure
85145804	GPSof1 (TX) [LC/PC] IP66 DC	1 SMA	1 LC/UPC	Outdoor enclosure
85139263	GPSof4 (TX) L1+L2	4 SMA	1 FC/APC	19" 1 RU
85154592	GPSof IP66 Mastmount Kit			Mast mount adapter

GPS-over-Fiber Receiver (RX) Modules (O/E Conversion)

Item-No	Product Description	# of RF Outputs	# FO Inputs	# FO outputs	Form factor
85065397	GPSof1 - 1.5GHz (RX)	1 SMA	1 FC/APC	-	Din Rail mount
85072906	GPSof1 - 1.5GHz (RX) L1+L2	1 SMA	1 FC/APC	-	Din Rail mount
85135573	GPSof1 (RX) [LC/PC] L1+L2	1 SMA	1 LC/UPC	-	Din Rail mount
85065809	GPSof4 - 1.5GHz (RX)	4 SMA	1 FC/APC	-	Din Rail mount
85072907	GPSof4 - 1.5GHz (RX) L1+L2	4 SMA	1 LC/UPC	-	Din Rail mount
85140587	GPSof4 - 1.5GHz (RX) [LC/PC]	4 SMA	1 LC/UPC	-	Din Rail mount
85134405	GPSof8 (RX)	8 SMA	1 LC/UPC	-	19" 1 RU
85127335	GPSof8 - 1.5GHz (RX) L1+L2	8 SMA	1 FC/APC	-	Din Rail mount
85134363	GPSof16 (RX)	16 SMA	1 LC/UPC	-	19" 1 RU
85145447	GPSof16-2 (RX)	16 SMA	1 LC/UPC	2 LC/UPC	19" 1 RU
85140926	GPSof32 (RX)	32 SMA	1 LC/UPC	-	19" 2 RU

GPS-over-Fiber antenna

Item-No	Product Description	Frequency range	Power supply
85160014	GNSS ANT L1+L2 3.3 V	L1+L2	3.3 V
85170543	GNSS ANT L1+L2 5 V		5.0 V

Direct GPS-over-Fiber portfolio

Direct GPS-over-Fiber Transmitter (TX) Module (Optical GNSS Antenna)

Item-No	Product Description	FO Interface	Form factor
85077810	Direct GPSof (TX)	QODC12	Antenna

Direct GPS-over-Fiber Receiver (RX) Modules (O/E Conversion)

Item-No	Product Description	# of RF Inputs	# FO Inputs	# FO outputs	Form factor
85128283	Direct GPSof - MAC8-1 (RX)	8 SMA	QODC12	1 LC/UPC	19" 1 RU

Direct GPS-over-Fiber KITS

Item-No	Product Description (SAP View)	Kit Includes
85134673	Direct GPSof - MAC8-1 Link	85128283 + 85077810

Additional modules

Item-No	Product Description	# RF/FO Inputs	#RF/FO Outputs	Form Factor
85128403	GPSof Amp Expansion Module 16	1 SMA	16 SMA	19" 1RU
85128404	GPSof Amp Expansion Module 32	1 SMA	16 SMA	19" 2RU
85154296	GPSof - OSM (1x8)	1 LC/UPC	8 LC/UPC	19" 1RU

GPS-over-Fiber Power Unit

Item-No	Product Description	Power Input	Power Output	Form Factor
85152769	Direct GPSof DC/DC Converter	2x -48VDC	2x 12VDC	19" 1RU

Portfolio overview

Fiber optic assemblies Q-ODC-12 Riser rated

Item-No	Product Description	Length (ft)	length (m)
85115099	MA12_QOP3_QOP3_A270R_15.2_BB	50	15.25
85115100	MA12_QOP3_QOP3_A270R_30.5_BB	100	30.5
85115101	MA12_QOP3_QOP3_A270R_45.7_BB	150	45.75
85115102	MA12_QOP3_QOP3_A270R_61.0_BB	200	61
85115103	MA12_QOP3_QOP3_A270R_76.2_BB	250	76.25
85115104	MA12_QOP3_QOP3_A270R_91.4_BB	300	91.5
85115105	MA12_QOP3_QOP3_A270R_107_BB	350	106.75
85115106	MA12_QOP3_QOP3_A270R_122_BB	400	122
85115107	MA12_QOP3_QOP3_A270R_137.2_BB	450	137.25
85142046	MA12_QOP3_QOP3_A270R_152.4_BB	500	152.5
85142047	MA12_QOP3_QOP3_A270R_183_BB	600	183
85142048	MA12_QOP3_QOP3_A270R_213.4_BB	700	213.5
85142049	MA12_QOP3_QOP3_A270R_244_BB	800	244
85159918	MA12_QOP3_QOP3_A270R_274.3_BB	900	274.5
85159919	MA12_QOP3_QOP3_A270R_305_BB	1000	305

Note: Q-ODC-12 Plenum rated assemblies are available upon request

RF cable assemblies

Item-No	Product Description	Interface	Length (ft)	Length (m)
85134446	LIS-C5-11SMA-11SMA-00305-55	SMA (m)	1	0.3
85134447	LIS-C5-11SMA-11SMA-00610-55	SMA (m)	2	0.6
85134454	LIS-C5-11SMA-11SMA-00914-55	SMA (m)	3	0.9
85134452	LIS-C5-11SMA-11SMA-01829-55	SMA (m)	6	1.8
85134450	LIS-C5-11SMA-11SMA-03658-55	SMA (m)	12	3.7
85134449	LIS-C5-11SMA-11SMA-04572-55	SMA (m)	18	5.5



Improve the business case of your mobile network infrastructure

[hubersuhner.com/en/onepager-minimicrosites/mobile-network-solutions](https://www.hubersuhner.com/en/onepager-minimicrosites/mobile-network-solutions)

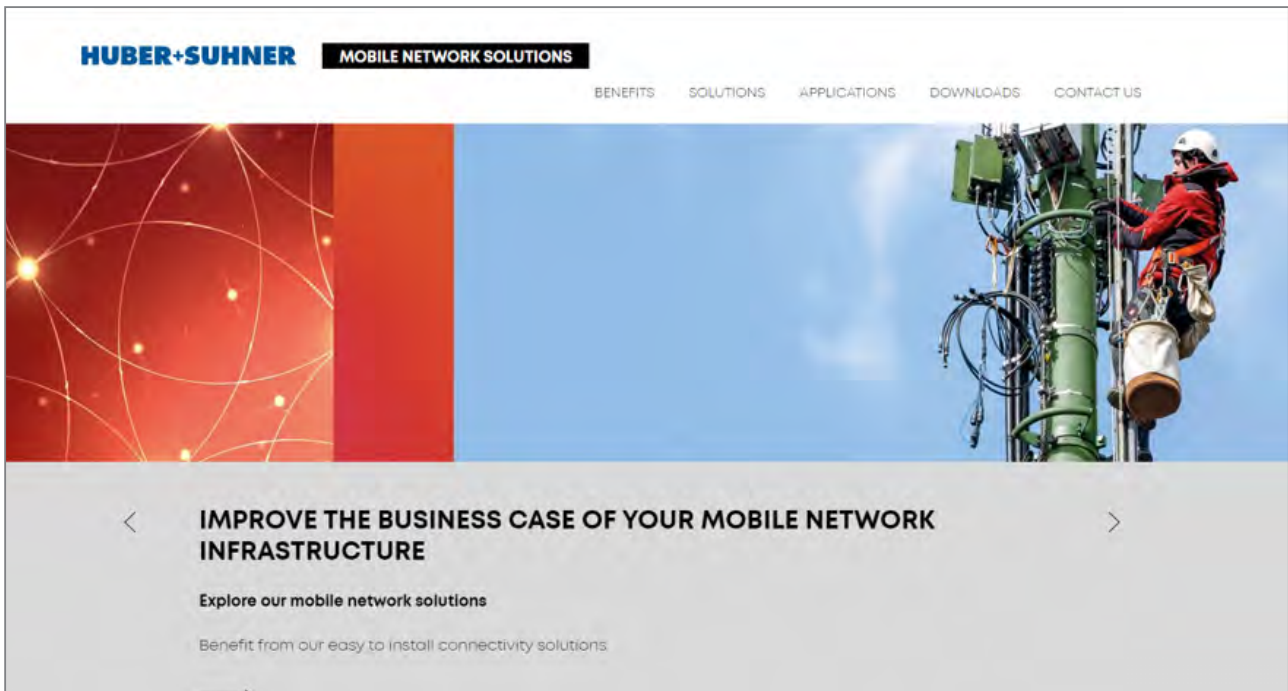

Today, consumers and companies alike are pushing the boundaries of mobile connectivity by requesting increasingly fast, reliable and environmentally conscious communications—everywhere.

At HUBER+SUHNER, we support you in continuously expanding the capacity and coverage of your network, while optimising the performance of existing infrastructure. Visit our microsite, <https://www.hubersuhner.com/en/onepager-minimicrosites/mobile-network-solutions>, for information about our mobile network solutions that ready your network for the future and reduce total cost of ownership across the entire life cycle of your cell sites.

HUBER+SUHNER AG
Degersheimerstrasse 14
9100 Herisau
Switzerland
Phone +41 71 353 41 11
hubersuhner.com

HUBER+SUHNER is certified to ISO 9001, ISO 14001, ISO 45001, EN/AS 9100, IATF 16949 and ISO/TS 22163-IRIS.

Waiver

Fact and figures herein are for information only and do not represent any warranty of any kind.